



# ESCONDIDO STORM WATER DESIGN MANUAL APPENDICES

(BMP Design Manual)

For Permanent Site Design with respect to Storm Water Treatment and  
Hydromodification Management



Adopted January 13, 2016  
Effective February 16, 2016  
Updated October 2022

# Table of Contents

<b>Appendix A</b>	<b>Submittal Guidelines</b>	<b>A-1</b>
A.1	Standard Project Submittals	A-1
A.2	PDP SWQMP Guide	A-1
<b>Appendix B</b>	<b>Storm Water Pollutant Control Hydrologic Calculations and Sizing Methods</b>	<b>B-1</b>
B.1	DCV	B-4
B.1.1	Runoff Factor	B-4
B.1.2	Offline BMPs	B-5
B.1.3	85th Percentile, 24-Hour Storm Event	B-5
B.2	Adjustments to Account for Site Design BMPs	B-9
B.2.1	Adjustment to Impervious Runoff Factor	B-9
B.2.2	Adjustment to DCV	B-11
B.3	Harvest and Use BMPs	B-15
B.3.1	Planning Level Harvest and Use Feasibility	B-15
B.3.2	Harvested Water Demand Calculation	B-17
B.3.3	Sizing Harvest and Use BMPs	B-21
B.4	Infiltration BMPs	B-22
B.4.1	Simple Method	B-23
B.4.2	Percent Capture Method	B-24
B.4.3	Technical Basis for Equivalent Sizing Methods	B-30
B.5	Biofiltration BMPs	B-32
B.5.1	Standard Biofiltration BMP Sizing	B-39
B.5.2	Non-Standard and Compact Biofiltration BMP Sizing	B-41
B.5.3	Basis for Minimum Sizing Factor for Biofiltration BMPs	B-65
B.5.4	Volume Retention Mechanisms	B-69
B.6	Flow-Thru Treatment Control BMPs (for use with Alternative Compliance)	B-81
B.6.1	PDP Most Significant Pollutants of Concern	B-81
B.6.2	Selection of Flow-Thru Treatment Control BMPs	B-83
B.6.3	Sizing Flow-Thru Treatment Control BMPs:	B-91
<b>Appendix C</b>	<b>Geotechnical and Groundwater Investigation Requirements</b>	<b>C-1</b>
C.1	Simple Feasibility Criteria	C-2

C.1.1	Infiltration Feasibility Condition Letter.....	C-3
C.2	Detailed Feasibility Criteria .....	C-4
C.2.1	Geotechnical Feasibility Criteria .....	C-5
C.2.2	Groundwater Quality and Water Balance Feasibility Criteria .....	C-8
C.3	Geotechnical and Groundwater Investigation Report Requirements.....	C-12
C.3.1	Site Evaluation .....	C-12
C.3.2	Field Investigation.....	C-12
C.3.3	Reporting Requirements by the Project Geotechnical Engineer.....	C-13
C.3.4	Reporting Requirements by the Project SWQMP Preparer .....	C-14
C.4	Feasibility Screening Exhibits .....	C-40
<b>Appendix D</b>	<b>Approved Infiltration Rate Assessment Methods for Selection and Design of Storm Water BMPs .....</b>	<b>D-1</b>
D.1	Introduction .....	D-1
D.2	Role of Infiltration Testing in Different Stages of Project Development.....	D-2
D.3	Guidance for Selecting Infiltration Testing Methods .....	D-2
D.3.1	Desktop Approaches and Data Correlation Methods.....	D-5
D.3.2	Surface and Shallow Excavation Methods .....	D-6
D.3.3	Deeper Subsurface Tests.....	D-9
D.3.4	Percolation Rate Conversion Example .....	D-11
D.4	Specific Considerations for Infiltration Testing.....	D-12
D.4.1	Hydraulic Conductivity versus Infiltration Rate versus Percolation Rate.....	D-12
D.4.2	Cut and Fill Conditions .....	D-12
D.4.3	Effects of Direct and Incidental Compaction .....	D-14
D.4.4	Temperature Effects on Infiltration Rate.....	D-15
D.4.5	Number of Infiltration Tests Needed.....	D-15
D.5	Selecting a Safety Factor .....	D-16
D.5.1	Determining Factor of Safety .....	D-16
D.5.2	Site Suitability Considerations for Selection of an Infiltration Factor of Safety .....	D-17
D.5.3	Design Related Considerations for Selection of an Infiltration Factor of Safety .....	D-18
D.5.4	Implications of a Factor of Safety in BMP Feasibility and Design .....	D-20
<b>Appendix E</b>	<b>BMP Design Fact Sheets .....</b>	<b>E-1</b>
	Fact Sheet Quick Guide.....	E-2
E.1	Source Control BMP Requirements .....	E-3

E.2	SC-Q Large Trash Generating Facilities .....	E-16
E.3	SC-R Animal Facilities .....	E-20
E.4	SC-S Plant Nurseries and Garden Centers .....	E-21
E.5	SC-T Automotive Facilities .....	E-22
E.6	SD-A Tree Well.....	E-24
E.7	SD-B Impervious Area Dispersion.....	E-33
E.8	SD-C Green Roofs .....	E-40
E.9	SD-D Permeable Pavement (Site Design BMP).....	E-47
E.10	SD-E Rain Barrels.....	E-53
E.11	SD-F Amended Soils.....	E-57
E.12	HU-1 Cistern .....	E-60
E.13	INF-1 Infiltration Basin.....	E-68
E.14	INF-2 Bioretention.....	E-78
E.15	INF-3 Permeable Pavement (Pollutant Control).....	E-91
E.16	INF-4 Dry Wells .....	E-105
E.17	PR-1 Biofiltration with Partial Retention.....	E-106
E.18	BF-1 Biofiltration.....	E-120
E.19	BF-2 Nutrient Sensitive Media Design.....	E-134
E.20	BF-3 Proprietary Biofiltration Systems .....	E-137
E.21	FT-1 Vegetated Swales.....	E-138
E.22	FT-2 Media Filters .....	E-148
E.23	FT-3 Sand Filters .....	E-155
E.24	FT-4 Dry Extended Detention Basin .....	E-165
E.25	FT-5 Proprietary Flow-Thru Treatment Control BMPs .....	E-175
E.26	PL Plant List .....	E-176
E.27	SL Sediment Loading .....	E-177
<b>Appendix F Biofiltration Standard and Checklist .....</b>		<b>F-1</b>
F.1	Pollutant Treatment Performance Standard.....	F-7
F.2	Guidance on Sizing and Design of Non-Standard Biofiltration BMPs .....	F-12
F.2.1	Guidance on Design per Conditions of Certification/Verification .....	F-12
F.2.2	Sizing of Flow-Based Biofiltration BMP .....	F-12
F.3	Bioretention Soil Media (BSM).....	F-14

**Appendix G Guidance for Continuous Simulation and Hydromodification Management Sizing Factors ..... G-1**

G.1 Guidance for Continuous Simulation Hydrologic Modeling for Hydromodification Management Studies in San Diego County Region 9 ..... G-1

G.1.1 Introduction ..... G-1

G.1.2 Software for Continuous Simulation Hydrologic Modeling..... G-1

G.1.3 Climatology Parameters..... G-2

G.1.4 Land Characteristics and Loss Parameters..... G-7

G.1.5 Modeling Structural BMPs (Ponds and Lid Features)..... G-18

G.1.6 Flow Frequency and Duration ..... G-26

G.2 Sizing Factors for Hydromodification Management BMPs..... G-30

G.2.1 Unit Runoff Ratios and Low Flow Control Orifice Design..... G-36

G.2.2 Sizing Factors for "Infiltration" BMP ..... G-39

G.2.3 Sizing Factors for Biofiltration with Partial Retention..... G-42

G.2.4 Sizing Factors for Biofiltration..... G-45

G.2.5 Sizing Factors for "Cistern" BMP..... G-48

**Appendix H Guidance for Investigating Potential Critical Coarse Sediment Yield Areas ..... H-1**

H.1 Step 1: Identify CCSYAs ..... H-2

H.1.1 Identification Methods ..... H-2

H.1.2 Refinement Options..... H-2

H.2 Step 2: Avoidance of Onsite CCSYAs ..... H-4

H.2.1 Avoidance Metrics..... H-4

H.3 Step 3: Bypass Onsite and Upstream CCSYAs..... H-4

H.3.1 Bypass CCSYAs from Hillslopes ..... H-4

H.3.2 Bypass CCSYAs from Channels ..... H-5

H.3.3 De Minimis Upstream CCSYA ..... H-6

H.4 Step 4: Demonstrate No Net Impact ..... H-7

H.4.1 Background ..... H-7

H.4.2 Management Standard ..... H-9

H.4.3 Types of Mitigation Measures ..... H-10

H.5 References ..... H-13

H.5.1 Terms of Reference..... H-14

H.6 PCCSYAs: Regional WMAA Maps ..... H-16

H.6.1 Site-Specific GLU Analysis .....	H-17
H.6.2 Assumptions for Regional WMAA PCCSYA Maps.....	H-32
H.6.3 Encroachment Allowance for Regional PCCSYA WMAA Map.....	H-33
H.7 Downstream System Sensitivity to Coarse Sediment.....	H-34
H.7.1 Depositional Analysis .....	H-34
H.7.2 Threshold Channel Analysis .....	H-35
H.7.3 Coarse Sediment Source Area Verification .....	H-43
H.8 Calculation Methodology for Ep and Sp .....	H-47
H.8.1 Calculation of Ep.....	H-47
H.8.2 Calculation of Sp .....	H-61
H.9 Mitigation Measures Fact Sheets .....	H-69
H.9.1 Additional flow control .....	H-71
H.9.2 Stream Rehabilitation.....	H-77
<b>Appendix I Forms and Checklists .....</b>	<b>I-1</b>
<b>Glossary of Key Terms.....</b>	<b>i</b>

Appendix

A

ESCONDIDO STORM WATER DESIGN MANUAL

# Submittal Guidelines

# Appendix A Submittal Guidelines

The following forms and checklists were developed to assist the project applicant and the plan reviewer in submitting the storm water components of any storm water development project:

- A.1 Standard Project Submittal
- A.2 PDP Storm Water Quality Management Plan (SWQMP) Guide

## A.1 Standard Project Submittals

The following submittals are required for non-PDP projects: Storm Water Standard Development Project Submittal form or Storm Water and Development Projects fact sheet (Minor Projects)

## A.2 PDP SWQMP Guide

A fillable PDP SWQMP Guide can be downloaded from the City's Storm Water Standards for New and Redevelopment Projects website: <https://www.escondido.org/bmps-for-new-development-redevelopment.aspx>. A completed SWQMP is required for all PDPs. The template is based on the following forms in Appendix I:

- I-2: Priority Development Project Submittal, including (a) Site Information Checklist for PDPs, (b) Source Control BMP Checklist for PDPs and (c) Site Design BMP Checklist for PDPs
- I-3: Summary of Structural BMPs
- I-7: Harvest and Use Feasibility Checklist
- I-8A: Categorization of Infiltration Feasibility Condition based on Geotechnical Conditions
- I-8B: Categorization of Infiltration Feasibility Condition based on Groundwater and Water Balance Conditions
- I-9: Factor of Safety and Design Infiltration Rate
- I-7: Determination of Downstream Systems Requirements for Preservation of Coarse Sediment Supply



Appendix

B

ESCONDIDO STORM WATER DESIGN MANUAL

# Storm Water Pollutant Control Hydrologic Calculations and Sizing Methods

# Appendix B Storm Water Pollutant Control Hydrologic Calculations and Sizing Methods

## Table of Contents:

- B.1. DCV
- B.2. Adjustments to Account for Site Design BMPs
- B.3. Harvest and Use BMPs
- B.4. Infiltration BMPs
- B.5. Biofiltration BMPs
- B.6. Flow-Thru Treatment Control BMPs (for use with Alternative Compliance)

Note: As part of the sizing process for each pollutant control BMP (i.e. infiltration, partial retention, biofiltration, or flow-thru BMP), applicants may be required to complete the sediment loading worksheet included in Appendix E.27. Completion of the worksheet is required when the media footprint of the proposed BMP is less than 3% of the contributing area times adjusted runoff factor.

**Appendix B: Storm Water Pollutant Control Hydrologic Calculations and Sizing Methods**

**Worksheet B-1: Tabular Summary of DMAs**

Tabular Summary of DMAs							Worksheet B-1		
DMA Unique Identifier	Area (acres)	Impervious Area (acres)	% Imp	HSG	Area Weighted Runoff Coefficient	DCV (cubic feet)	Treated By (BMP ID)	Pollutant Control Type	Drain to (POC ID)
Summary of DMA Information (Must match project description and SWQMP Narrative)									
No. of DMAs	Total DMA Area (acres)	Total Impervious Area (acres)	% Imp		Area Weighted Runoff Coefficient	Total DCV (cubic feet)	Total Area Treated (acres)		No. of POCs

## Appendix B: Storm Water Pollutant Control Hydrologic Calculations and Sizing Methods

This page was intentionally left blank.

## Appendix B: Storm Water Pollutant Control Hydrologic Calculations and Sizing Methods

### B.1 DCV

DCV is defined as the volume of storm water runoff resulting from the 85<sup>th</sup> percentile, 24-hr storm event. The following hydrologic method shall be used to calculate the DCV:

$$DCV = C \times d \times A \times 43,560 \text{ sf/ac} \times 1/12 \text{ in/ft}$$
$$DCV = 3,630 \times C \times d \times A$$

Where:

DCV = Design Capture Volume in cubic feet

C = Runoff factor (unitless); refer to section B.1.1

d = 85<sup>th</sup> percentile, 24-hr storm event rainfall depth (inches), refer to section B.1.3

A = Tributary area (acres) which includes the total area draining to the BMP, including any offsite or onsite areas that comingles with project runoff and drains to the BMP. Refer to Chapter 3, Section 3.3.3 for additional guidance. Street redevelopment projects consult section 1.4.3.

Worksheets B-1 and Worksheet B.2-1 may be used to document DCV calculations for individual BMPs and for the project site as a whole.

#### B.1.1 Runoff Factor

Estimate the area weighted runoff factor for the tributary area to the BMP using runoff factor (from Table B.1-1) and area of each surface type in the tributary area and the following equation:

$$C = \frac{\sum C_x A_x}{\sum A_x}$$

Where:

C<sub>x</sub> = Runoff factor for area X

A<sub>x</sub> = Tributary area X (acres)

These runoff factors apply to areas receiving direct rainfall only. For conditions in which runoff is routed onto a surface from an adjacent surface, see Section B.2 for determining composite runoff factors for these areas.

## Appendix B: Storm Water Pollutant Control Hydrologic Calculations and Sizing Methods

**Table B.1-1: Runoff factors for surfaces draining to BMPs – Pollutant Control BMPs**

Surface	Runoff Factor
Roofs <sup>1</sup>	0.90
Concrete or Asphalt <sup>1</sup>	0.90
Unit Pavers (grouted) <sup>1</sup>	0.90
Decomposed Granite	0.30
Cobbles or Crushed Aggregate	0.30
Amended, Mulched Soils or Landscape	0.10
Compacted Soil (e.g., unpaved parking)	0.30
Natural (A Soil)	0.10
Natural (B Soil)	0.14
Natural (C Soil)	0.23
Natural (D Soil)	0.30

<sup>1</sup>Surface is considered impervious and could benefit from use of Site Design BMPs and adjustment of the runoff factor per Section B.2.1.

### B.1.2 Offline BMPs

Diversion flow rates for offline BMPs shall be sized to convey the maximum flow rate of runoff produced from a rainfall intensity of 0.2 inch of rainfall per hour, for each hour of every storm event. The following hydrologic method shall be used to calculate the diversion flow rate for off-line BMPs:

$$Q = C \times i \times A$$

Where:

Q = Diversion flow rate in cubic feet per second

C = Runoff factor, area weighted estimate using Table B.1-1

i = Rainfall intensity of 0.2 in/hr

A = Tributary area (acres) which includes the total area draining to the BMP, including any offsite or onsite areas that comeingle with project runoff and drain to the BMP. Refer to Chapter 3, Section 3.3.3 for additional guidance. Street redevelopment projects also consult Section 1.4.3.

### B.1.3 85th Percentile, 24-Hour Storm Event

The City of Escondido 85th percentile, 24-hour isopluvial map is provided as Figure B.1-1. The rainfall depth to estimate the DCV shall be determined using Figure B.1-1. The methodology used to develop this map is presented below:

## Appendix B: Storm Water Pollutant Control Hydrologic Calculations and Sizing Methods

### B.1.3.1 Gauge data and calculation of 85th percentile

The method of calculating the 85th percentile is to produce a list of values, order them from smallest to largest, and then pick the value that is 85 percent of the way through the list. Only values that are capable of producing run off are of interest for this purpose. Lacking a legislative definition of rainfall values capable of producing runoff, Flood Control staff in San Diego County have observed that the point at which significant runoff begins is rather subjective, and is affected by land use type and soil moisture. In highly-urbanized areas, the soil has a high impermeability and runoff can begin with as little as 0.02" of rainfall. In rural areas, soil impermeability is significantly lower and even 0.30" of rain on dry soil will frequently not produce significant runoff. For this reason, San Diego County has chosen to use the more objective method of including all non-zero 24-hour rainfall totals when calculating the 85th percentile. To produce a statistically significant number, only stations with 30 years or greater of daily rainfall records are used.

### B.1.3.2 Mapping the gauge data

A collection of 56 precipitation gauge points was developed with 85th percentile precipitation values based on multiple years of gauge data. A raster surface (grid of cells with values) was interpolated from that set of points. The surface initially did not cover the County's entire jurisdiction. A total of 13 dummy points were added. Most of those were just outside the County boundary to enable the software to generate a surface that covered the entire County. A handful of points were added to enforce a plausible surface. In particular, one point was added in the desert east of Julian, to enforce a gradient from high precipitation in the mountains to low precipitation in the desert. Three points were added near the northern boundary of the County to adjust the surface to reflect the effect of elevation in areas lacking sufficient operating gages.

Several methods of interpolation were considered. The method chosen is named by Environmental Systems Research Institute as the Natural Neighbor technique. This method produces a surface that is highly empirical, with the value of the surface being a product of the values of the data points nearest each cell. It does not produce peaks or valleys of surface based on larger area trends, and is free of artifacts that appeared with other methods.

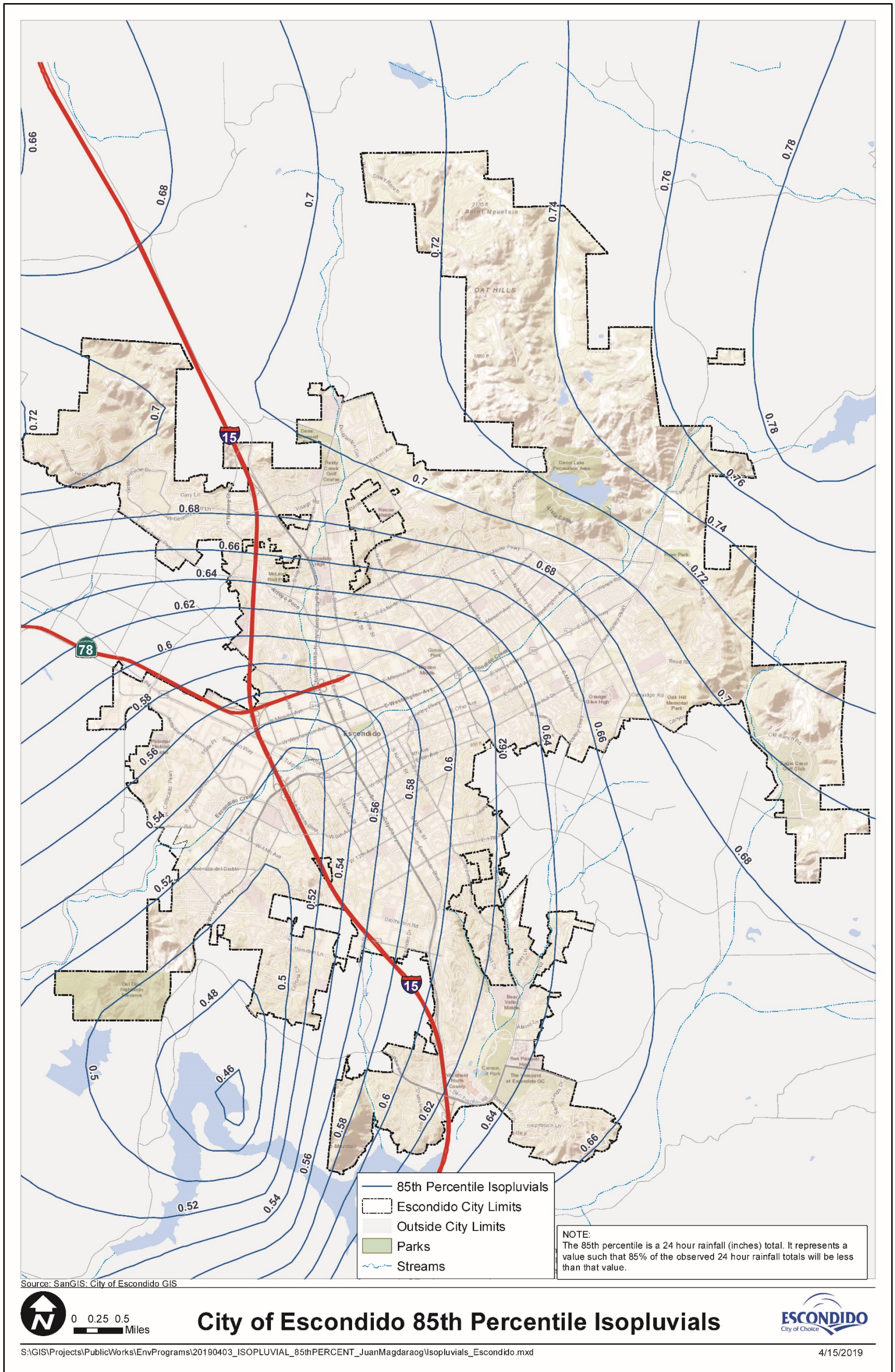

Figure B.1-1: City of Escondido 85th Percentile 24-hour Isopluvial Map



This page was intentionally left blank.

### B.2 Adjustments to Account for Site Design BMPs

This section provides methods to adjust the DCV (for sizing pollutant control BMPs) as a result of implementing site design BMPs. The adjustments are provided by one of the following two methods:

- Adjustment to impervious runoff factor
- Adjustment to DCV

#### B.2.1 Adjustment to Impervious Runoff Factor

When one of the following site design BMPs is implemented the runoff factor of 0.9 for impervious surfaces identified in Table B.1-1 should be adjusted using the factors listed below and an adjusted area weighted runoff factor shall be estimated following guidance from Section B.1.1 and used to calculate the DCV.

- SD-B Impervious area dispersion
- SD-C Green roofs
- SD-D Permeable pavement

##### B.2.1.1 Impervious area dispersion (SD-B)

Dispersion of impervious areas through pervious areas: The following adjustments are allowed to impervious runoff factors when dispersion is implemented in accordance with the SD-B fact sheet (Appendix E). Adjustments are only credited up to a 4:1 maximum ratio of impervious to pervious areas. In order to adjust the runoff factor, the pervious area shall have a minimum width of 10 feet and a maximum slope of 5% (exemption to this minimum width criterion is allowed when the contributing flow path length of the impervious area /pervious area width  $\leq 2$ ). Based on the ratio of **impervious area to pervious area** and the hydrologic soil group of the pervious area, the adjustment factor from Table B.2-1 shall be multiplied with the unadjusted runoff factor (Table B.1-1) of the impervious area to estimate the adjusted runoff factor for sizing pollutant control BMPs. The adjustment factors in Table B.2-1 are **only** valid for impervious surfaces that have an unadjusted runoff factor of 0.9.

## Appendix B: Storm Water Pollutant Control Hydrologic Calculations and Sizing Methods

**Table B.2-1: Impervious area adjustment factors that accounts for dispersion**

Pervious area hydrologic soil group	Ratio = Impervious area/Pervious area			
	<=1	2	3	4
A	0.00	0.00	0.23	0.36
B	0.00	0.27	0.42	0.53
C	0.34	0.56	0.67	0.74
D	0.86	0.93	0.97	1.00

Continuous simulation modeling in accordance with Appendix G is required to develop adjustment factors for surfaces that have an unadjusted runoff factor less than 0.9. Approval of adjustment factors for surfaces that have an unadjusted runoff factor less than 0.9 is at the discretion of the City Engineer. The adjustment factors in Table B.2-1 were developed by performing continuous simulations in SWMM with default parameters from Appendix G and impervious to pervious area ratios of 1, 2, 3, and 4. When using adjustment factors from Table B.2-1:

- **Linear interpolation** shall be performed if the impervious to pervious area ratio of the site is in between one of ratios for which an adjustment factor was developed;
- Use adjustment factor for a ratio of 1 when the impervious to pervious area ratio is less than 1; and
- Adjustment factor is not allowed when the impervious to pervious area ratio is greater than 4, when the pervious area is designed as a site design BMP.

**Example B.2-1:** DMA is comprised of one acre of impervious area that drains to a 0.4 acre hydrologic soil group B pervious area and then the pervious area drains to a BMP. Impervious area dispersion is implemented in the DMA in accordance with SD-B factsheet. Estimate the adjusted runoff factor for the DMA.

- Baseline Runoff Factor per Table B.1-1 =  $[(1*0.9+0.4*0.14)/1.4] = 0.68$ .
- Impervious to Pervious Ratio = 1 acre impervious area/ 0.4 acre pervious area = 2.5; since the ratio is 2.5 adjustment can be claimed.
- From Table B.2-1 the adjustment factor for hydrologic soil group B and a ratio of 2 = 0.27; ratio of 3 = 0.42.
- Linear interpolated adjustment factor for a ratio of 2.5 =  $0.27 + \{[(0.42 - 0.27)/(3-2)]*(2.5-2)\} = 0.345$ .
- Adjusted runoff factor for the DMA =  $[(1*0.9*0.345+0.4*0.14)/1.4] = 0.26$ .
- Note only the runoff factor for impervious area is adjusted, there is no change made to the pervious area.

## Appendix B: Storm Water Pollutant Control Hydrologic Calculations and Sizing Methods

### B.2.1.2 Green Roofs

When green roofs are implemented in accordance with the SD-C factsheet the green roof footprint shall be assigned a runoff factor of 0.10 for adjusted runoff factor calculations.

### B.2.1.3 Permeable Pavement

When a permeable pavement is implemented in accordance with the SD-D factsheet and it does not have an impermeable liner and has storage greater than the 85<sup>th</sup> percentile depth below the underdrain, if an underdrain is present, then the footprint of the permeable pavement shall be assigned a runoff factor of 0.10 for adjusted runoff factor calculations.

Permeable Pavement can also be designed as a structural BMP to treat run on from adjacent areas. Refer to INF-3 factsheet and Appendix B.4 for additional guidance.

## B.2.2 Adjustment to DCV

When the following site design BMPs are implemented the anticipated volume reduction from these BMPs shall be deducted from the DCV to estimate the volume for which the downstream structural BMP should be sized for:

- SD-A: Tree Wells
- SD-E: Rain barrels

### B.2.2.1 Tree Wells

Tree well credit volume from tree trenches or boxes (tree BMPs) is a sum of three runoff reduction volumes provided by trees that decrease the required DCV for a tributary area. The following reduction in DCV is allowed per tree based on the mature diameter of the tree canopy, when trees are implemented in accordance with SD-A factsheet and meet the following criteria:

- Total tree credit volume is less than 0.25DCV of the project footprint and
- Single tree credit volume is less than 400 ft<sup>3</sup>

Credit for trees that do not meet the above criteria shall be based on the criteria for sizing the tree as a storm water pollutant control BMP in SD-A fact sheet. Copermittees may deviate from the above criteria by developing additional sizing guidance and design requirements.

## Appendix B: Storm Water Pollutant Control Hydrologic Calculations and Sizing Methods

- Plot tree wells designed for tree credit volume or pollutant control to ultimate canopy size on plans.

Mature Tree Canopy Diameter (ft)	Tree Credit Volume (ft <sup>3</sup> /tree)
5	10
10	40
15	100
20	180
25	290
30	400

### *Basis for the reduction in DCV:*

Tree credit volume was estimated based on typical characteristics of tree wells as follows:

It is assumed that each tree and associated trench or box is considered a single BMP, with calculations based on the media storage volume and/or the individual tree within the tree BMP as appropriate. Tree credit volume is calculated as:

$$TCV = TIV + TCIV + TETV$$

Where:

- $TCV$  = Tree credit volume (ft<sup>3</sup>)
- $TIV$  = Total infiltration volume of all storage layers within tree BMPs (ft<sup>3</sup>)
- $TCIV$  = Total canopy interception volume of all individual trees within tree BMPs (ft<sup>3</sup>)
- $TETV$  = Total evapotranspiration volume, sums the media evapotranspiration storage within each tree BMP (ft<sup>3</sup>)

Total infiltration volume was calculated as the total volume infiltrated within the BMP storage layers. Infiltration volume was assumed to be 20% of the total BMP storage layer volume, the available pore space in the soil volume (porosity – field capacity). Total canopy interception volume was calculated for all tree wells within the tributary area as the average interception capacity for the entire mature tree total canopy projection area. Interception capacity was determined to be 0.04 inches for all tree well sizes, an average from the findings published by Breuer et al (2003) for coniferous and deciduous trees. Total evapotranspiration volume is the available evapotranspiration storage volume (field

## **Appendix B: Storm Water Pollutant Control Hydrologic Calculations and Sizing Methods**

capacity – wilting point) within the BMP storage layer media. TEVT is assumed to be 10% of the minimum soil volume. The minimum soil volume as required by SD-A fact sheet of 2 cubic feet per unit canopy projection area was assumed for estimating reduction in DCV.

### **B.2.2.2 Rain Barrels**

Rain barrels are containers that can capture rooftop runoff and store it for future use. Credit can be taken for the full rain barrel volume when each barrel volume is smaller than 100 gallons, implemented per SD-E fact sheet and meet the following criteria:

- Total rain barrel volume is less than 0.25 DCV and
- Landscape areas are greater than 30 percent of the project footprint.

Credit for harvest and use systems that do not meet the above criteria shall be based on the criteria in Appendix B.3 and HU-1 fact sheet.

**Appendix B: Storm Water Pollutant Control Hydrologic Calculations and Sizing Methods**

**Worksheet B.2-1. BMP Design Capture Volume**

Design Capture Volume		Worksheet B-2.1		
1	85 <sup>th</sup> percentile 24-hr storm depth from Figure B.1-1	d=		inches
2	Area tributary to BMP (s)	A=		acres
3	Area weighted runoff factor (estimate using Appendix B.1.1 and B.2.1)	C=		unitless
4	Tree well volume reduction	TCV=		cubic-feet
5	Rain barrels volume reduction	RCV=		cubic-feet
6	Calculate DCV = (3630 x C x d x A) – TCV - RCV	DCV=		cubic-feet

### B.3 Harvest and Use BMPs

The purpose of this section is to provide guidance for evaluating feasibility of harvest and use BMPs, calculating harvested water demand and sizing harvest and use BMPs.

#### B.3.1 Planning Level Harvest and Use Feasibility

Harvest and use feasibility should be evaluated at the scale of the entire project, and not limited to a single DMA. For the purpose of initial feasibility screening, it is assumed that harvested water collected from one DMA could be used within another. Types of non-potable water demand that may apply within a project include:

- Toilet and urinal flushing
- Irrigation
- Vehicle washing
- Evaporative cooling
- Dilution water for recycled water systems
- Industrial processes
- Other non-potable uses

Worksheet B.3-1 provides a screening process for determining the preliminary feasibility for harvest and use BMPs. This worksheet should be completed for the overall project.



**Appendix B: Storm Water Pollutant Control Hydrologic Calculations and Sizing Methods**

**Worksheet B.3-1. Harvest and Use Feasibility Screening**

Harvest and Use Feasibility Screening		Worksheet B.3-1
<p>1. Is there a demand for harvested water (check all that apply) at the project site that is reliably present during the wet season?</p> <p><input type="checkbox"/> Toilet and urinal flushing</p> <p><input type="checkbox"/> Landscape irrigation</p> <p><input type="checkbox"/> Other: _____</p>		
<p>2. If there is a demand; estimate the anticipated average wet season demand over a period of 36 hours. Guidance for planning level demand calculations for toilet/urinal flushing and landscape irrigation is provided in Section B.3.2.</p> <p>[Provide a summary of calculations here]</p>		
<p>3. Calculate the DCV using worksheet B-2.1.</p> <p>[Provide a results here]</p>		
<p>3a. Is the 36-hour demand greater than or equal to the DCV?</p> <p align="center">Yes / No ⇒ ↓</p>	<p>3b. Is the 36-hour demand greater than 0.25DCV but less than the full DCV?</p> <p align="center">Yes / No ⇒ ↓</p>	<p>3c. Is the 36-hour demand less than 0.25DCV?</p> <p align="center">Yes ↓</p>
<p>Harvest and use appears to be feasible. Conduct more detailed evaluation and sizing calculations to confirm that DCV can be used at an adequate rate to meet drawdown criteria.</p>	<p>Harvest and use may be feasible. Conduct more detailed evaluation and sizing calculations to determine feasibility. Harvest and use may only be able to be used for a portion of the site, or (optionally) the storage may need to be upsized to meet long term capture targets while draining in longer than 36 hours.</p>	<p>Harvest and use is considered to be infeasible.</p>

Note: 36-hour demand calculations are for feasibility analysis only. Once feasibility analysis is complete the applicant may be allowed to use a different drawdown time provided they meet the 80% annual capture standard (refer to B.4.2) and 96-hour vector control drawdown requirement.

## Appendix B: Storm Water Pollutant Control Hydrologic Calculations and Sizing Methods

### B.3.2 Harvested Water Demand Calculation

The following sections provide technical references and guidance for estimating the harvested water demand of a project. These references are intended to be used for the planning phase of a project for feasibility screening purposes.

#### B.3.2.1 Toilet and Urinal Flushing Demand Calculations

The following guidelines should be followed for computing harvested water demand from toilet and urinal flushing:

- If reclaimed water is planned for use for toilet and urinal flushing, then the demand for harvested storm water is equivalent to the total demand minus the reclaimed water supplied, and should be reduced by the amount of reclaimed water that is available during the wet season.
- Demand calculations for toilet and urinal flushing should be based on the average rate of use during the wet season for a typical year.
- Demand calculations should include changes in occupancy over weekends and around holidays and changes in attendance/enrollment over school vacation periods.
- For facilities with generally high demand, but periodic shut downs (e.g., for vacations, maintenance, or other reasons), a project specific analysis should be conducted to determine whether the long term storm water capture performance of the system can be maintained despite shut downs.
- Such an analysis should consider the statistical distributions of precipitation and demand, most importantly the relationship of demand to the wet seasons of the year.

Table B.3-1 provides planning level demand estimates for toilet and urinal flushing per resident, or employee, for a variety of project types. The per capita use per day is based on daily employee or resident usage. For non-residential types of development, the “visitor factor” and “student factor” (for schools) should be multiplied by the employee use to account for toilet and urinal usage for non-employees using facilities.

Note: Table B.3-1 provides a demand estimate for 24 hours, for feasibility analysis this estimate must be multiplied by 1.5 to calculate the 36-hour demand.

## Appendix B: Storm Water Pollutant Control Hydrologic Calculations and Sizing Methods

**Table B.3-1. Toilet and Urinal Water Usage per Resident or Employee**

Land Use Type	Toilet User Unit of Normalization	Per Capita Use per Day		Visitor Factor <sup>4</sup>	Water Efficiency Factor	Total Use per Resident or Employee
		Toilet Flushing <sup>1, 2</sup>	Urinals <sup>3</sup>			
Residential	Resident	18.5	NA	NA	0.5	9.3
Office	Employee (non-visitor)	9.0	2.27	1.1	0.5	7 (avg)
Retail	Employee (non-visitor)	9.0	2.11	1.4	0.5	
Schools	Employee (non-student)	6.7	3.5	6.4	0.5	33
Various Industrial Uses (excludes process water)	Employee (non-visitor)	9.0	2	1	0.5	5.5

1 - Based on American Waterworks Association Research Foundation, 1999. Residential End Uses of Water. Denver, CO: AWWARF

2 - Based on use of 3.45 gallons per flush and average number of per employee flushes per subsector, Table D-1 for MWD (Pacific Institute, 2003)

3 - Based on use of 1.6 gallons per flush, Table D-4 and average number of per employee flushes per subsector, Appendix D (Pacific Institute, 2003)

4 - Multiplied by the demand for toilet and urinal flushing for the project to account for visitors. Based on proportion of annual use allocated to visitors and others (includes students for schools; about 5 students per employee) for each subsector in Table D-1 and D-4 (Pacific Institute, 2003)

5 - Accounts for requirements to use ultra low flush toilets in new development projects; assumed that requirements will reduce toilet and urinal flushing demand by half on average compared to literature estimates. Ultra low flush toilets are required in all new construction in California as of January 1, 1992. Ultra low flush toilets must use no more than 1.6 gallons per flush and Ultra low flush urinals must use no more than 1 gallon per flush. Note: If zero flush urinals are being used, adjust accordingly.

### B.3.2.2 General Requirements for Irrigation Demand Calculations

The following guidelines should be followed for computing harvested water demand from landscape irrigation:

- If reclaimed water is planned for use for landscape irrigation, then the demand for harvested storm water should be reduced by the amount of reclaimed water that is available during the wet season.
- Irrigation rates should be based on the irrigation demand exerted by the types of landscaping that are proposed for the project, with consideration for water conservation requirements.
- Irrigation rates should be estimated to reflect the average wet season rates (defined as October through April) accounting for the effect of storm events in offsetting harvested water demand. In the absence of a detailed demand study, it should be assumed that irrigation demand is not present during days with greater than 0.1 inches of rain and the subsequent 3-day period. This irrigation shutdown period is consistent with standard practice in land application of

## Appendix B: Storm Water Pollutant Control Hydrologic Calculations and Sizing Methods

wastewater and is applicable to storm water to prevent irrigation from resulting in dry weather runoff. Based on a statistical analysis of San Diego County rainfall patterns, approximately 30 percent of wet season days would not have a demand for irrigation.

- If land application of storm water is proposed (irrigation in excess of agronomic demand), then this BMP must be considered to be an infiltration BMP and feasibility screening for infiltration must be conducted. In addition, it must be demonstrated that land application would not result in greater quantities of runoff as a result of saturated soils at the beginning of storm events. Agronomic demand refers to the rate at which plants use water.

The following sections describe methods that should be used to calculate harvested water irrigation demand. While these methods are simplified, they provide a reasonable estimate of potential harvested water demand that is appropriate for feasibility analysis and project planning. These methods may be replaced by a more rigorous project-specific analysis that meets the intent of the criteria above.

### B.3.2.2.1 Demand Calculation Method

This method is based on the San Diego Municipal Code Land Development Code Landscape Standards Appendix E which includes a formula for estimating a project's annual estimated total water use based on reference evaporation, plant factor, and irrigation efficiency.

For the purpose of calculating harvested water irrigation demand applicable to the sizing of harvest and use systems, the estimated total water use has been modified to reflect typical wet-season irrigation demand. This method assumes that the wet season is defined as October through April. This method further assumes that no irrigation water will be applied during days with precipitation totals greater than 0.1 inches or within the 3 days following such an event. Based on these assumptions and an analysis of Lake Wohlford, Lindbergh and Oceanside precipitation patterns, irrigation would not be applied during approximately 30 percent of days from October through April.

The following equation is used to calculate the Modified Estimated Total Water Usage:

$$\text{Modified ETWU} = \text{ET}_{\text{Owet}} \times [(\sum(\text{PF} \times \text{HA})/\text{IE}) + \text{SLA}] \times 0.015$$

Where:

Modified ETWU = Estimated daily average water usage during wet season

ET<sub>Owet</sub> = Average reference evapotranspiration from October through April (use 2.8 inches per month, using CIMS Zone 4 from Table G.1-1)

PF = Plant Factor

## Appendix B: Storm Water Pollutant Control Hydrologic Calculations and Sizing Methods

**Table B.3-2. Planning Level Plant Factor Recommendations**

Plant Water Use	Plant Factor	Also Includes
Low	< 0.1 – 0.2	Artificial Turf
Moderate	0.3 – 0.7	
High	0.8 and greater	Water features
Special Landscape Area	1.0	

HA = Hydrozone Area (sq-ft); A section or zone of the landscaped area having plants with similar water needs.

$\Sigma(PF \times HA)$  = The sum of PF x HA for each individual Hydrozone (accounts for different landscaping zones).

IE = Irrigation Efficiency (assume 90 percent for demand calculations)

SLA = Special Landscape Area (sq-ft); Areas used for active and passive recreation areas, areas solely dedicated to the production of fruits and vegetables, and areas irrigated with reclaimed water.

In this equation, the coefficient (0.015) accounts for unit conversions and shut down of irrigation during and for the three days following a significant precipitation event:

$$0.015 = (1 \text{ mo}/30 \text{ days}) \times (1 \text{ ft}/12 \text{ in}) \times (7.48 \text{ gal}/\text{cu-ft}) \times (\text{approximately } 7 \text{ out of } 10 \text{ days with irrigation demand from October through April})$$

### B.3.2.2.2 Planning Level Irrigation Demands

To simplify the planning process, the method described above has been used to develop daily average wet season demands for a one-acre irrigated area based on the plant/landscape type. These demand estimates can be used to calculate the drawdown of harvest and use systems for the purpose of LID BMP sizing calculations.

**Table B.3-3. Planning Level Irrigation Demand by Plant Factor and Landscape Type**

General Landscape Type	36-Hour Planning Level Irrigation Demand (gallons per irrigated acre per 36 hour period)
Hydrozone – Low Plant Water Use	390
Hydrozone – Moderate Plant Water Use	1,470
Hydrozone – High Plant Water Use	2,640
Special Landscape Area	2,640

## Appendix B: Storm Water Pollutant Control Hydrologic Calculations and Sizing Methods

### B.3.2.3 Calculating Other Harvested Water Demands

Calculations of other harvested water demands should be based on the knowledge of land uses, industrial processes, and other factors that are project-specific. Demand should be calculated based on the following guidelines:

- Demand calculations should represent actual demand that is anticipated during the wet season (October through April).
- Sources of demand should only be included if they are reliably and consistently present during the wet season.
- Where demands are substantial but irregular, a more detailed analysis should be conducted based on a statistical analysis of anticipated demand and precipitation patterns.

### B.3.3 Sizing Harvest and Use BMPs

Sizing calculations shall demonstrate that one of two equivalent performance standards is met:

1. Harvest and use BMPs are sized to drain the tank in 36 hours following the end of rainfall. The size of the BMP is dependent on the demand (Section B.3.2) at the site.
2. Harvest and use BMP is designed to capture at least 80 percent of average annual (long term) runoff volume.

It is rare cisterns can be sized to capture the full DCV and use this volume in 36 hours. So when using Worksheet B.3-1 if it is determined that harvest and use BMP is feasible then the BMP should be sized to the estimated 36-hour demand.

## B.4 Infiltration BMPs

Sizing calculations shall demonstrate that one of two equivalent performance standards is met:

1. The BMP or series of BMPs captures the DCV and infiltrates this volume fully within 36 hours following the end of precipitation. This can be demonstrated through the Simple Method (Section B.4.1).
2. The BMP or series of BMPs infiltrates at least 80 percent of average annual (long term) runoff volume. This can be demonstrated using the percent capture method (Section B.4.2), through reporting of output from the San Diego Hydrology Model, or through other continuous simulation modeling meeting the criteria in Appendix G, as acceptable to the City Engineer. This method is **not** applicable for sizing biofiltration BMPs.

The methods to show compliance with these standards are provided in the following sections.

## Appendix B: Storm Water Pollutant Control Hydrologic Calculations and Sizing Methods

### B.4.1 Simple Method

#### Stepwise Instructions:

1. Compute DCV using Worksheet B.4-1
2. Estimate design infiltration rate using Worksheet D.5-1
3. Design BMP(s) to ensure that the DCV is fully retained (i.e., no surface discharge during the design event) and the stored effective depth draws down in no longer than 36 hours.

**Worksheet B.4-1: Simple Sizing Method for Infiltration BMPs**

Simple Sizing Method for Infiltration BMPs		Worksheet B.4-1		
1	DCV (Worksheet B-2.1)	DCV=		cubic-feet
2	Estimated design infiltration rate	$K_{\text{design}}=$		in/hr
3	Available BMP surface area	$A_{\text{BMP}}=$		sq-ft
4	Average effective depth in the BMP footprint ( $DCV/A_{\text{BMP}}$ )	$D_{\text{avg}}=$		feet
5	Drawdown time, T ( $D_{\text{avg}} * 12 / K_{\text{design}}$ )	T=		hours
6	Provide alternative calculation of drawdown time, if needed.			
7	Provide calculations for effective depth provided in the BMP: Effective Depth = Surface ponding (below the overflow elevation) + gravel storage thickness x gravel porosity (0.4)			

#### Notes:

- Drawdown time must be less than 36 hours. This criterion was set to achieve average annual capture of 80% to account for back to back storms (See rationale in Section B.4.3). In order to use a different drawdown time, BMPs should be sized using the percent capture method (Section B.4.2).
- The average effective depth calculation should account for any aggregate/media in the BMP. For example, 4 feet of stone at a porosity of 0.4 would equate to 1.6 feet of effective depth.
- This method may overestimate drawdown time for BMPs that drain through both the bottom and walls of the system. BMP specific calculations of drawdown time may be provided that account for BMP-specific geometry.



## Appendix B: Storm Water Pollutant Control Hydrologic Calculations and Sizing Methods

### B.4.2 Percent Capture Method

This section describes the recommended method of sizing volume-based BMPs to achieve the 80 percent capture performance criterion. This method has a number of potential applications for sizing BMPs, including:

- Use this method when a BMP can draw down in less than 36 hours and it is desired to demonstrate that 80 percent capture can be achieved using a BMP volume smaller than the DCV.
- Use this method to determine how much volume (greater than the DCV) must be provided to achieve 80 percent capture when the drawdown time of the BMP exceeds 36 hours.
- Use this method to determine how much volume should be provided to achieve 80 percent capture when upstream BMP(s) have achieved some capture, but have not achieved 80 percent capture.

By nature, the percent capture method is an iterative process that requires some initial assumptions about BMP design parameters and subsequent confirmation that these assumptions are valid. For example, sizing calculations depend on the assumed drawdown time, which depends on BMP depth, which may in turn need to be adjusted to provide the required volume within the allowable footprint. In general, the selection of reasonable BMP design parameters in the first iteration will result in minimal required additional iterations. Figure B.4-1 presents the nomograph for use in sizing retention BMPs in San Diego County.

Appendix B: Storm Water Pollutant Control Hydrologic Calculations and Sizing Methods

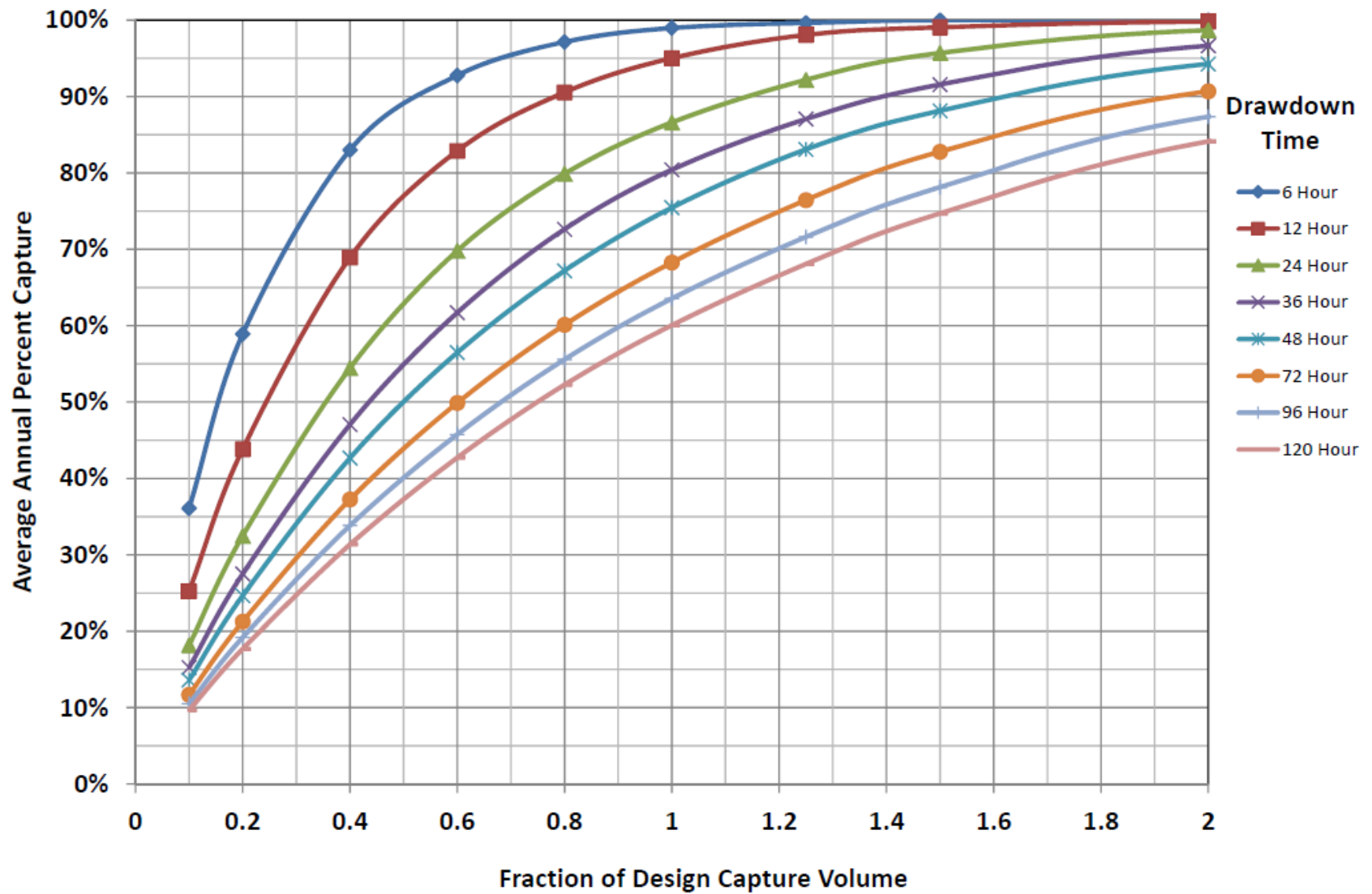

Figure B.4-1: Percent Capture Nomograph

## Appendix B: Storm Water Pollutant Control Hydrologic Calculations and Sizing Methods

This page was intentionally left blank

**B.4.2.1 Stepwise Instructions for sizing a single BMP**

1. Estimate the drawdown time of the proposed BMP by estimating the design infiltration rate (Worksheet D.5-1) and accounting for BMP dimensions/geometry. See the applicable BMP Fact Sheet for specific guidance on how to convert BMP geometry to estimated drawdown time.
2. Using the estimated drawdown time and the nomograph from Figure B.4-1 locate where the line corresponding to the estimated drawdown time intersects with 80 percent capture. Pivot to the X axis and read the fraction of the DCV that needs to be provided in the BMP to achieve this level of capture.
3. Calculate the DCV using Worksheet B.2-1.
4. Multiply the result of Step 2 by the DCV (Step 3). This is the required BMP design volume.
5. Design the BMP to retain the required volume, and confirm that the drawdown time is no more than 25 percent greater than estimated in Step 1. If the computed drawdown time is greater than 125 percent of the estimated drawdown, then return to Step 1 and revise the initial drawdown time assumption.

See the respective BMP facts sheets for BMP-specific instructions for the calculation of volume and drawdown time. The above method can also be used to size and/or evaluate the performance of other retention BMPs (evapotranspiration, harvest and use) that have a drawdown rate that can be approximated as constant throughout the year or over the wet season. In order to use this method for other retention BMPs, drawdown time in Step 1 will need to be evaluated using an applicable method for the type of BMP selected. After completing Step 1 continue to Step 2 listed above.

**Example B.4.2.1 Percent Capture Method for Sizing a Single BMP:**

Given:
<ul style="list-style-type: none"> <li>• Estimated drawdown time: 72 Hours</li> <li>• DCV: 3000 ft<sup>3</sup></li> </ul>
Required:
<ul style="list-style-type: none"> <li>• Determine the volume required to achieve 80 percent capture.</li> </ul>
Solution:
<ol style="list-style-type: none"> <li>1. Estimated drawdown time = 72 Hours</li> <li>2. Fraction of DCV required = 1.35</li> <li>3. DCV = 3000 ft<sup>3</sup> (Given for this example; To be estimated using Worksheet B.2-1)</li> <li>4. Required BMP volume = 1.35 x 3000 = 4050 ft<sup>3</sup></li> <li>5. Design BMP and confirm drawdown Time is ≤ 90 Hours (72 Hours +25%)</li> </ol>

Example B.4.2.1 Continued:

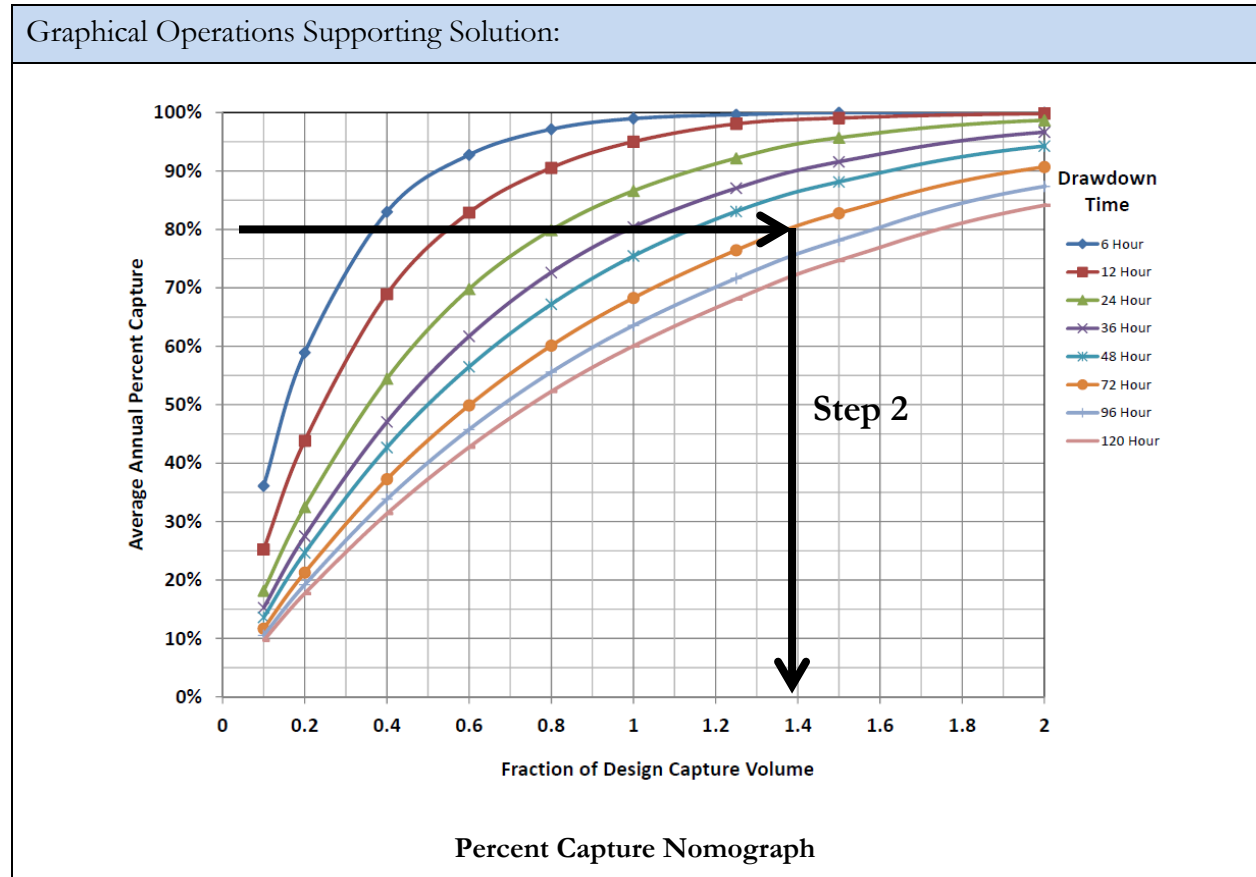

**B.4.2.2 Stepwise Instructions for sizing BMPs in series**

For projects where BMPs in series have to be implemented to meet the performance standard the following stepwise procedure shall be used to size the downstream BMP to achieve the 80 percent capture performance criterion:

1. Using the upstream BMP parameters (volume and drawdown time) estimate the average annual capture efficiency achieved by the upstream BMP using the nomograph.
2. Estimate the drawdown time of the proposed downstream BMP by estimating the design infiltration rate (Worksheet D.5-1) and accounting for BMP dimensions/geometry. See the applicable BMP Fact Sheet for specific guidance on how to convert BMP geometry to estimated drawdown time. Use the nomograph and locate where the line corresponding to the estimated drawdown time intersects with 80 percent capture. Pivot to the horizontal axis and read the fraction of the DCV that needs to be provided in the BMP. This is referred to as  $X_1$ .
3. Trace a horizontal line on the nomograph using the capture efficiency of the upstream BMP estimated in Step 1. Find where the line traced intersects with the drawdown time of the downstream BMP (Step 2). Pivot and read down to the horizontal axis to yield the fraction of the DCV already provided by the upstream BMP. This is referred to as  $X_2$ .

## Appendix B: Storm Water Pollutant Control Hydrologic Calculations and Sizing Methods

4. Subtract  $X_2$  (Step 3) from  $X_1$  (Step 2) to determine the fraction of the design volume that must be provided in the downstream BMP to achieve 80 percent capture to meet the performance standard.
5. Multiply the result of Step 4 by the DCV. This is the required downstream BMP design volume.
6. Design the BMP to retain the required volume, and confirm that the drawdown time is no more than 25 percent greater than estimated in Step 2. If the computed drawdown time is greater than 125 percent of the estimated drawdown, then return to Step 2 and revise the initial drawdown time assumption.

See the respective BMP facts sheets for BMP-specific instructions for the calculation of volume and drawdown time.

### Example B.4.2.2 Percent Capture Method for Sizing BMPs in Series:

Given:
<ul style="list-style-type: none"> <li>• Estimated drawdown time for downstream BMP: 72 Hours</li> <li>• DCV for the area draining to the BMP: 3000 ft<sup>3</sup></li> <li>• Upstream BMP volume: 900 ft<sup>3</sup></li> <li>• Upstream BMP drawdown time: 24 Hours</li> </ul>
Required:
<ul style="list-style-type: none"> <li>• Determine the volume required in the downstream BMP to achieve 80 percent capture.</li> </ul>
Solution:
<ol style="list-style-type: none"> <li>1. Step 1A: Upstream BMP Capture Ratio = <math>900/3000 = 0.3</math>; Step 1B: Average annual capture efficiency achieved by upstream BMP = 44%</li> <li>2. Downstream BMP drawdown = 72 hours; Fraction of DCV required to achieve 80% capture = 1.35</li> <li>3. Locate intersection of design capture efficiency and drawdown time for upstream BMP (See Graph); Fraction of DCV already provided (<math>X_2</math>) = 0.50 (See Graph)</li> <li>4. Fraction of DCV Required by downstream BMP = <math>1.35 - 0.50 = 0.85</math></li> <li>5. DCV (given) = 3000 ft<sup>3</sup> ; Required downstream BMP volume = <math>3000 \text{ ft}^3 \times 0.85 = 2,550 \text{ ft}^3</math></li> <li>6. Design BMP and confirm drawdown Time is <math>\leq 90</math> Hours (72 Hours +25%)</li> </ol>

## Appendix B: Storm Water Pollutant Control Hydrologic Calculations and Sizing Methods

### Example B.4.2.2 Continued:

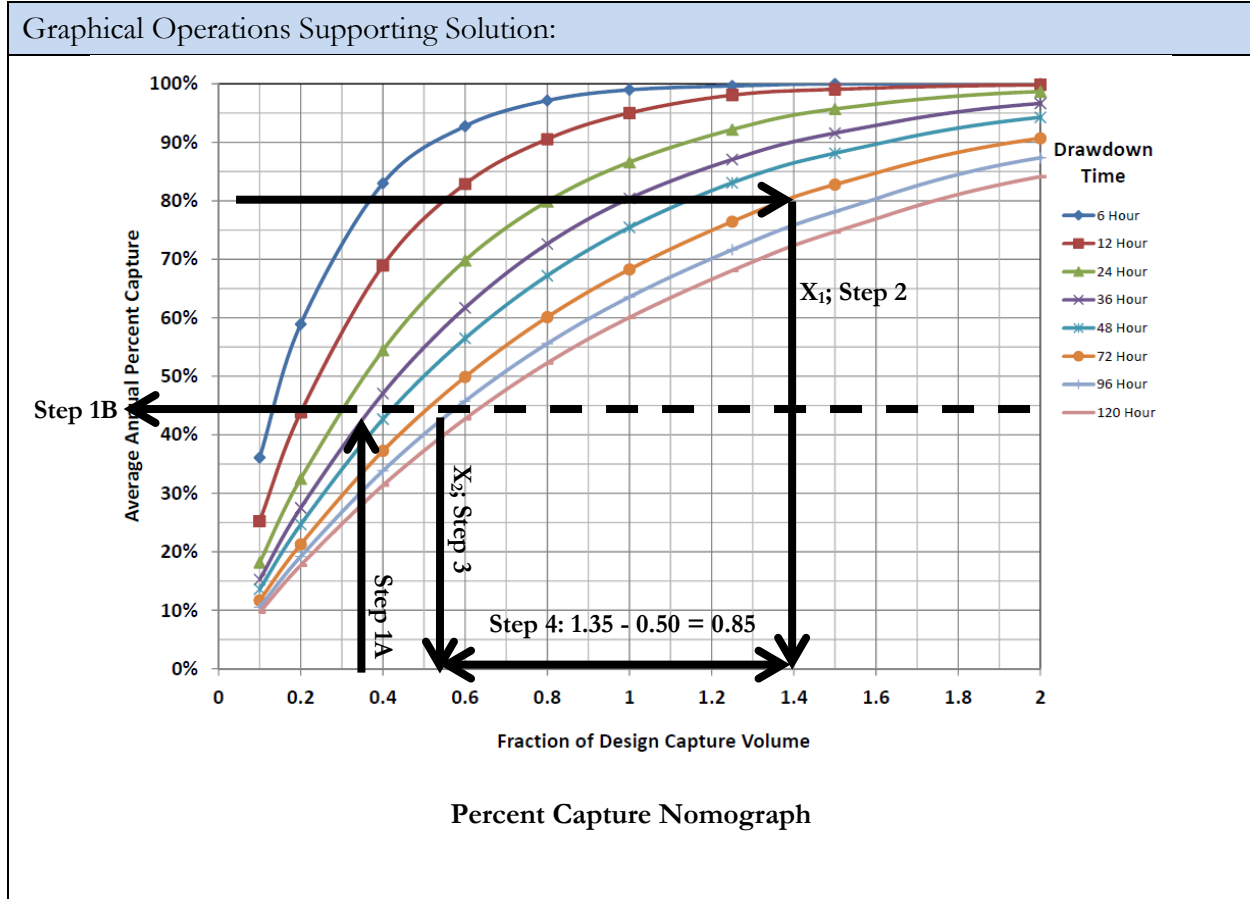

### B.4.3 Technical Basis for Equivalent Sizing Methods

Storm water BMPs can be conceptualized as having a storage volume and a treatment rate, in various proportions. Both are important in the long-term performance of the BMP under a range of actual storm patterns, depths, and inter-event times. Long-term performance is measured by the operation of a BMP over the course of multiple years, and provides a more complete metric than the performance of a BMP during a single event, which does not take into account antecedent conditions, including multiple storms arriving in short timeframes. A BMP that draws down more quickly would be expected to capture a greater fraction of overall runoff (i.e., long-term runoff) than an identically sized BMP that draws down more slowly. This is because storage is made available more quickly, so subsequent storms are more likely to be captured by the BMP. In contrast a BMP with a long drawdown time would stay mostly full, after initial filling, during periods of sequential storms. The volume in the BMP that draws down more quickly is more “valuable” in terms of long term performance than the volume in the one that draws down more slowly. The MS4 permit definition of

## Appendix B: Storm Water Pollutant Control Hydrologic Calculations and Sizing Methods

the DCV does not specify a drawdown time, therefore the definition is not a complete indicator of a BMP's level of performance. An accompanying performance-based expression of the BMP sizing standard is essential to ensure uniformity of performance across a broad range of BMPs and helps prevent BMP designs from being used that would not be effective.

An evaluation of the relationships between BMP design parameters and expected long term capture efficiency has been conducted to address the needs identified above. Relationships have been developed through a simplified continuous simulation analysis of precipitation, runoff, and routing, that relate BMP design volume and storage recovery rate (i.e., drawdown time) to an estimated long term level of performance using United States Environmental Protection Agency (USEPA) SWMM and parameters listed in Appendix G for Lake Wohlford, Lindbergh, and Oceanside rain gauges. Comparison of the relationships developed using the three gauges indicated that the differences in relative capture estimates are within the uncertainties in factors used to develop the relationships. For example, the estimated average annual capture for the BMP sized for the DCV and 36 hour drawdown using Lake Wohlford, Lindbergh, and Oceanside are 80%, 76% and 83% respectively. In an effort to reduce the number of curves that are made available, relationships developed using Lake Wohlford are included in this manual for use in the whole San Diego County region.

Figure B.4-1 demonstrated that a BMP sized for the runoff volume from the 85<sup>th</sup> percentile, 24-hour storm event (i.e., the DCV), which draws down in 36 hours is capable of managing approximately 80 percent of the average annual. There is long precedent for 80 percent capture of average annual runoff as approximately the point at which larger BMPs provide decreasing capture efficiency benefit (also known as the “knee of the curve”) for BMP sizing. The characteristic shape of the plot of capture efficiency versus storage volume in Figure B.4-1 illustrates this concept.

As such, this equivalency (between DCV draw down in 36-hours and 80 percent capture) has been utilized to provide a common currency between volume-based BMPs with a wide range of drawdown rates. This approach allows flexibility in the design of BMPs while ensuring consistent performance.



## B.5 Biofiltration BMPs

Biofiltration BMPs must be sized using one of the following sizing methods:

- **Option 1:** Treat 1.5 times the portion of the DCV not reliably retained onsite, **OR**
- **Option 2:** Treat 1.0 times the portion of the DCV not reliably retained onsite; and additionally check that the system has a total static (i.e., non-routed) storage volume, including pore spaces and pre-filter detention volume, equal to at least 0.75 times the portion of the DCV not reliably retained onsite.

When using sizing Option 1 a routing period of 6 hours is allowed. The routing period was estimated based on 50th percentile storm duration for storms similar to 85th percentile rainfall depth. It was estimated based on inspection of continuous rainfall data from Lake Wohlford, Lindbergh and Oceanside rain gages.

The MS4 Permit specifies (Footnote 29) that the hydraulic loading rate and other biofiltration design criteria must be selected such that **storm water retention and pollutant removal** are maximized. To meet this provision, this manual includes specific criteria for design of biofiltration BMPs. Among other criteria, a minimum footprint sizing factor of 3 percent (BMP footprint area as percent of contributing area times adjusted runoff factor) and a volume retention performance standard (Figure B.5-2) based on the reliable infiltration rate at the site (i.e. measured infiltration rate/factor of safety of 2) is specified. Appendix B.5.3 provides the technical rationale for the 3 percent minimum sizing factor and the volume retention performance standard.

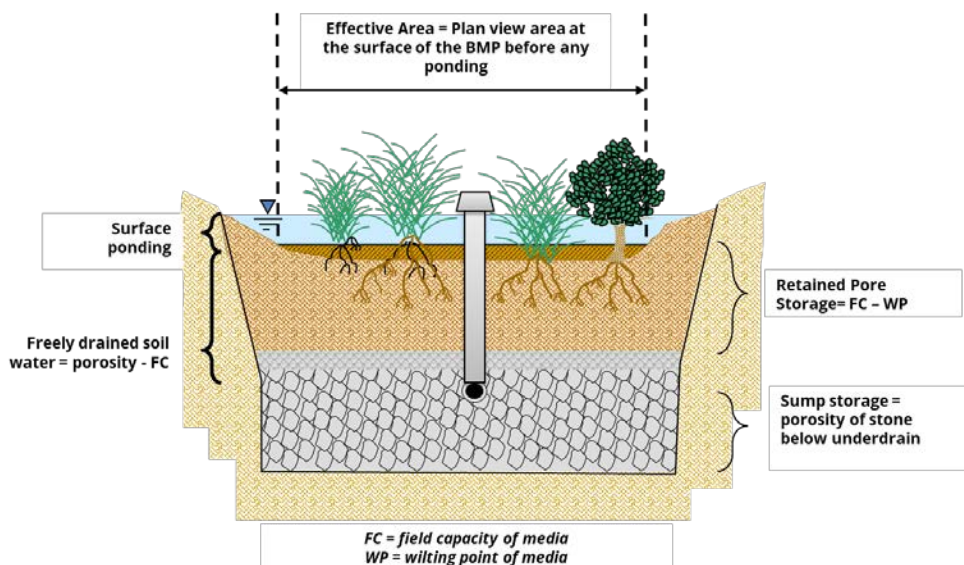

Figure B.5-1 Explanation of Biofiltration Volume Compartments for Sizing Purposes

## Appendix B: Storm Water Pollutant Control Hydrologic Calculations and Sizing Methods

**Note:** For sizing calculations, it shall be assumed that only 50% of the retained pore storage (field capacity – wilting point) is available for evapotranspiration to account for typical irrigation practices.

The numeric sizing criteria in this appendix are subdivided into:

- Appendix B.5.1: Standard<sup>1</sup> biofiltration BMP sizing; and
- Appendix B.5.2: Non-Standard<sup>2</sup> and Compact<sup>3</sup> biofiltration BMP sizing.

If a BMP meets the criteria in Appendix B.5.1, then it is considered compliant with the required pollutant control performance standard (i.e., for both retention and pollutant removal). It is not necessary to complete worksheets in this appendix for BMPs that meet the criteria in Appendix B.5.1. The volume retention performance standard for biofiltration BMPs is presented in Figure B.5-2.

When mapped hydrologic soil groups are used for feasibility screening, applicants are allowed to use the following reliable infiltration rates for sizing partial retention BMPs:

- Reliable infiltration rate for NRCS Type D soils = 0.05 in/hr.
- Reliable infiltration rate for NRCS Type C soils = 0.15 in/hr.

The applicant also has an option to perform infiltration testing in lieu of using the rates listed above.

If an applicant performs site-specific testing using a device that has a precision of 0.1 in/hr. and determines that the average measured infiltration rates in the DMA are less than 0.1 in/hr., then the applicant is allowed to size the biofiltration BMP assuming the DMA is a “No Infiltration Condition”. In instances where the actual infiltration is not measured because the testing device has a precision of 0.1 in/hr., if the applicant elects to propose a non-standard or a compact biofiltration BMP then a reliable infiltration rate of 0.025 in/hr. must be used to size site design BMPs when there are no geotechnical and/or groundwater hazards identified in Appendix C.

---

1 Standard biofiltration BMPs have a media filtration rate equal to or smaller than 5 in/hr. and a media surface area of 3% of contributing area times adjusted runoff factor or greater.

2 Non-Standard biofiltration BMPs have a media filtration rate equal to or smaller than 5 in/hr. and a media surface area smaller than 3% of contributing area times adjusted runoff factor.

3 Compact (high rate) biofiltration BMPs have a media filtration rate greater than 5 in/hr. and a media surface area smaller than 3% of contributing area times adjusted runoff factor. Compact biofiltration BMPs are typically proprietary BMPs that may qualify as biofiltration.

## **Appendix B: Storm Water Pollutant Control Hydrologic Calculations and Sizing Methods**

If there are geotechnical and/or groundwater hazards identified in Appendix C, then the applicant must use a reliable infiltration rate of 0.0 in/hr. for estimating the target volume retention and sizing equivalent site design BMPs.

The required performance standards for different biofiltration BMPs are summarized in Table B.5-1.

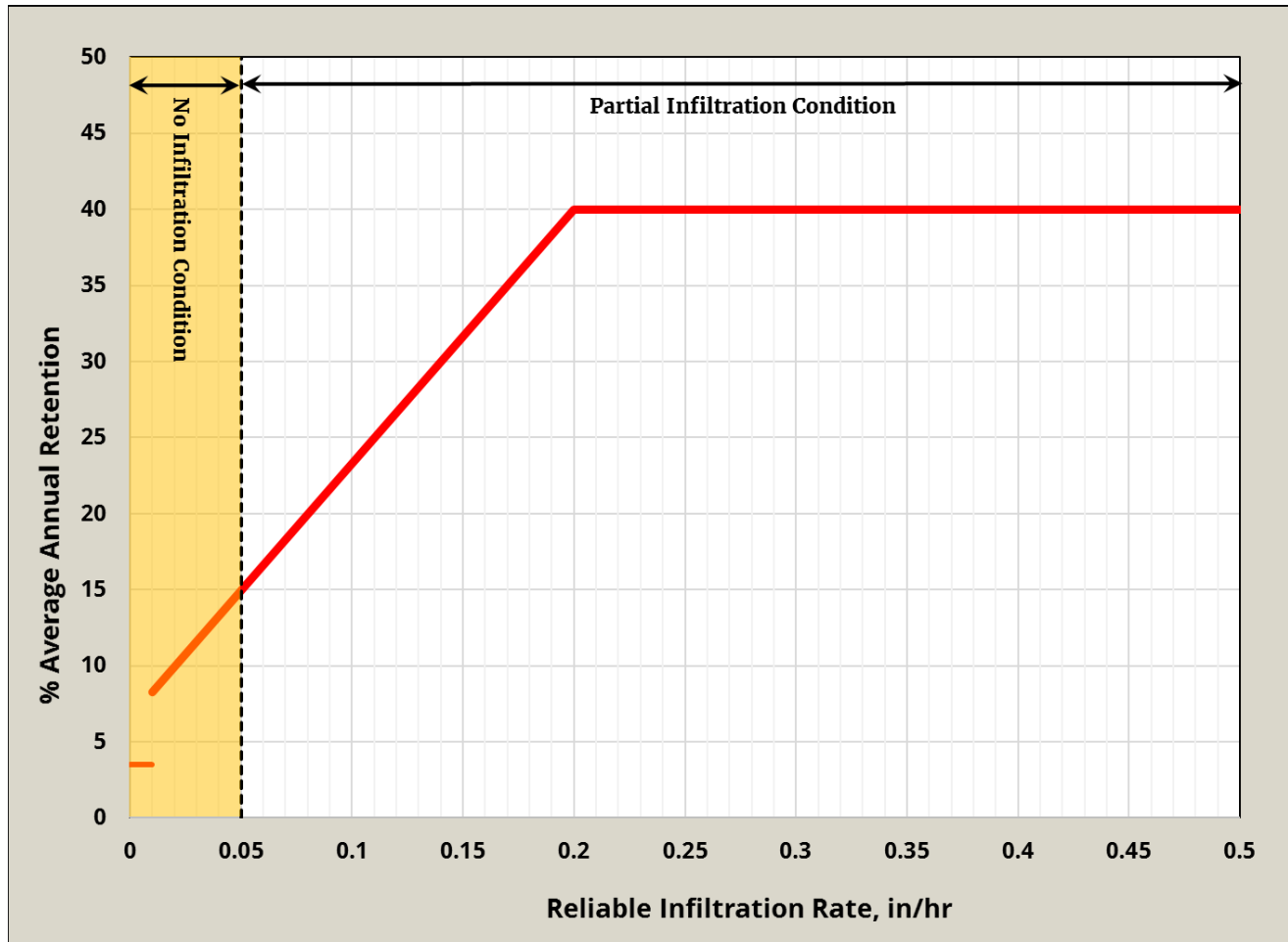

Figure B.5-2 Volume Retention Performance Standard for Partial Infiltration Condition

**Note:** For biofiltration BMP sizing, the reliable infiltration rate must be calculated using a factor of safety of 2 i.e., **Reliable infiltration rate = Measured infiltration rate/2**

## Appendix B: Storm Water Pollutant Control Hydrologic Calculations and Sizing Methods

This page intentionally left blank

**Appendix B: Storm Water Pollutant Control Hydrologic Calculations and Sizing Methods**

**Table B.5-1. Summary of Biofiltration Performance Standards**

Infiltration Feasibility Condition	Performance Standard
<p><b>Partial Infiltration Condition</b></p> <p><b>(Based on Worksheet C.4-1: Form I-8A and Worksheet C.4-2: Form I-8B)</b></p> <p><b>[There is no hierarchy in selecting the type of biofiltration BMP as long as the performance standard for the selected biofiltration BMP is met]</b></p>	<p><b><u>Standard Biofiltration BMPs:</u></b></p> <p>BMPs must meet the criteria in Appendix B.5.1.1</p>
	<p><b><u>Non-Standard Biofiltration BMPs:</u></b></p> <p><u>Pollutant Removal:</u> BMP must be sized using Worksheet B.5-1 and Worksheet B.5-4; <b>AND</b></p> <p><u>Volume Retention:</u> DMA must meet the target volume retention calculated using Worksheet B.5-2 (based on Figure B.5-2).</p> <p>Compliance with volume retention requirements can be documented using Worksheet B.5-3 (to estimate retention from the BMP) and/or Worksheet B.5-7 (if dispersion and/or amended soils are proposed) and/or by implementing other site design BMPs (e.g. rain barrels, trees, etc.).</p>
	<p><b><u>Compact Biofiltration BMPs:</u></b></p> <p><u>Pollutant Removal:</u> BMP must meet the criteria in Appendix F. Form I-10 must be completed and submitted with the PDP SWQMP; <b>AND</b></p> <p><u>Volume Retention:</u> DMA must meet the target volume retention calculated using Worksheet B.5-2 (based on Figure B.5-2).</p> <p>Compliance with volume retention requirements can be documented using Worksheet B.5-3 (to estimate retention from the BMP) and/or Worksheet B.5-7 (if dispersion and/or amended soils are proposed) and/or by implementing other site design BMPs (e.g. rain barrels, trees, etc.).</p>

**Appendix B: Storm Water Pollutant Control Hydrologic Calculations and Sizing Methods**

Infiltration Feasibility Condition	Performance Standard
<p><b>No Infiltration Condition</b> <b>(Based on Infiltration Feasibility Condition Letter and/or Worksheet C.4-1: Form I-8A and/or Worksheet C.4-2: Form I-8B)</b></p> <p>[There is no hierarchy in selecting the type of biofiltration BMP as long as the performance standard for the selected biofiltration BMP is met]</p>	<p><b><u>Standard Biofiltration BMPs:</u></b> BMPs must meet the criteria in Appendix B.5.1.2</p>
	<p><b><u>Non-Standard Biofiltration BMPs:</u></b> <u>Pollutant Removal:</u> BMP must be sized using Worksheet B.5-1 and Worksheet B.5-4; <b>AND</b> <u>Volume Retention:</u> DMA must meet the target volume retention calculated using Worksheet B.5-2 (based on Figure B.5-2). Compliance with volume retention requirements can be documented by:</p> <ul style="list-style-type: none"> <li>• DMA has a combined BMP footprint and landscaped area (that meet the criteria in SD-B and SD-F factsheet) of 3% of contributing area times adjusted runoff factor or greater. The landscaped area must have an impervious area to pervious area ratio greater than 1.5:1. This can be documented using Worksheet B.5-6. [OR]</li> <li>• Applicant has an option to use other site design BMPs that will meet the target volume retention calculated using Worksheet B.5-2. This can be documented using Worksheet B.5-6 and/or Worksheet B.5-7.</li> </ul>
	<p><b><u>Compact Biofiltration BMPs:</u></b> <u>Pollutant Removal:</u> BMP must meet the criteria in Appendix F. Form I-10 must be completed and submitted with the PDP SWQMP; <b>AND</b> <u>Volume Retention:</u> DMA must meet the target volume retention calculated using Worksheet B.5-2 (based on Figure B.5-2). Compliance with volume retention requirements can be documented by:</p> <ul style="list-style-type: none"> <li>• DMA has a combined BMP footprint and landscaped area (that meet the criteria in SD-B and SD-F factsheet) of 3% of contributing area times adjusted runoff factor or greater. The landscaped area must have an impervious area to pervious area ratio greater than 1.5:1. This can be documented using Worksheet B.5-6. [OR]</li> <li>• Applicant has an option to use other site design BMPs that will meet the target volume retention calculated using Worksheet B.5-2. This can be documented using Worksheet B.5-6 and/or Worksheet B.5-7.</li> </ul>

## Appendix B: Storm Water Pollutant Control Hydrologic Calculations and Sizing Methods

### B.5.1 Standard Biofiltration BMP Sizing

#### B.5.1.1 Standard Biofiltration Sizing for Partial Infiltration Condition

If a BMP meets the following criteria and the design criteria in PR-1 fact sheet (Appendix E.17), then the BMP is considered to meet its pollutant control performance standard.

- 1) DMA is categorized as “partial infiltration condition”. Complete Worksheet C.4-1: Form I-8A and Worksheet C.4-2: Form I-8B are submitted with the PDP SWQMP;
- 2) BMP has a media surface area of 3% of contributing area times adjusted runoff factor or greater and does not have an impermeable liner on the bottom of the BMP;
- 3) Additional documentation (Worksheet B.5-1) that show the pollutant control requirements are met is included in the SWQMP submittal if the media filtration rate of the BMP is outlet controlled (example for outlet control: underdrain outlet retrofitted with an orifice cap that controls the filtration flow rate); **AND**
- 4) BMP provides an aggregate storage thickness greater than the thickness specified in Table B.5-2 below the underdrain invert.

**Table B.5-2. Reliable infiltration rate versus required aggregate storage**

Reliable Infiltration Rate (in/hr.)	Minimum Aggregate Storage Thickness (inches) below the underdrain invert
≥ 0.05 in/hr. and ≤ 0.10 in/hr.	6 inches
> 0.10 in/hr. and ≤ 0.15 in/hr.	12 inches
> 0.15 in/hr. and < 0.50 in/hr.	18 inches

**Note:** For biofiltration BMP sizing, the design infiltration rate must be calculated using a factor of safety of 2, i.e., **Reliable infiltration rate = Measured infiltration rate/2.**

When mapped hydrologic soil groups are used for feasibility screening, applicants are allowed to use the following reliable infiltration rates for sizing partial retention BMPs:

- Reliable infiltration rate for NRCS Type D soils = 0.05 in/hr.
- Reliable infiltration rate for NRCS Type C soils = 0.15 in/hr.

The applicant also has an option to perform infiltration testing in lieu of using the rates listed above.

To document compliance applicant must include the following information in the SWQMP submittal for each standard BMP:



## Appendix B: Storm Water Pollutant Control Hydrologic Calculations and Sizing Methods

- Required BMP Footprint = Area draining to the BMP \* Adjusted runoff factor \* 0.03;
- Provided BMP Footprint;
- Reliable Infiltration rate;
- Provided aggregate storage thickness below the underdrain invert
- Documentation that shows the BMP meets the requirements in PR-1 fact sheet (Appendix E.17); and
- Completed Worksheet B.5-1 if the BMP is the outlet controlled. Worksheet B.5-1 is not required if the BMP is not outlet controlled.

### B.5.1.2 Standard Biofiltration Sizing in No Infiltration Condition

If a BMP meets the following criteria and the design criteria in BF-1 fact sheet (Appendix E.18), then the BMP is considered to meet its pollutant control performance standard.

- 1) DMA is categorized as “no infiltration condition”. Completed “Infiltration Feasibility Condition Letter” or Worksheet C.4-1: Form I-8A or Worksheet C.4-2: Form I-8B that supports the categorization submitted with the PDP SWQMP;
- 2) BMP has a media surface area of 3% of contributing area times adjusted runoff factor or greater and has an impermeable liner on the bottom of the BMP (applicant also has an option to not install an impermeable liner on the bottom of the BMP if there are no geotechnical/groundwater hazards identified while completing forms in Appendix C); **AND**
- 3) Additional documentation (Worksheet B.5-1) that show the pollutant control requirements are met is included in the SWQMP submittal if the media filtration rate of the BMP is outlet controlled (example for outlet control: underdrain outlet retrofitted with an orifice cap that controls the filtration flow rate).

To document compliance applicant must include the following information in the SWQMP submittal for each standard BMP:

- Required BMP Footprint = Area draining to the BMP \* Adjusted runoff factor \* 0.03;
- Provided BMP Footprint;

## **Appendix B: Storm Water Pollutant Control Hydrologic Calculations and Sizing Methods**

- Documentation that shows the BMP meets the requirements in BF-1 fact sheet (Appendix E.18); and
- Completed Worksheet B.5-1 if the BMP is the outlet controlled. Worksheet B.5-1 is not required if the BMP is not outlet controlled.

BMPs that meet the criteria in Appendix B.5.1 are not required to complete and submit Worksheets in Appendix B.5.2 in the PDP SWQMP submittal (except in scenarios where the biofiltration BMP is outlet controlled in this case applicant must complete Worksheet B.5-1 and include in the SWQMP submittal).

### **B.5.2 Non-Standard and Compact Biofiltration BMP Sizing**

The following worksheets were developed for project applicants electing to use non-standard non-proprietary biofiltration BMPs and/or use compact biofiltration BMPs.

- Worksheet B.5.1: Sizing Method for Pollutant Removal Criteria
- Worksheet B.5.2: Sizing Method for Volume Retention Criteria
- Worksheet B.5.3: Volume Retention from Biofiltration with Partial Retention BMPs
- Worksheet B.5.4: Alternative Minimum Footprint Sizing Factor for Non-Standard Biofiltration
- Worksheet B.5.5: Optimized Biofiltration BMP Footprint when Downstream of a Storage Unit
- Worksheet B.5.6: Volume Retention for No Infiltration Condition
- Worksheet B.5.7: Volume Retention from Amended Soils

#### **Notes:**

1. Project applicants that meet the criteria in Appendix B.5.1 are not required to complete the worksheets in Appendix B.5.2.
2. Project applicants have an option to perform continuous simulation (following guidelines in Appendix G) to document conformance with the performance standard from Chapter 2 in

## Appendix B: Storm Water Pollutant Control Hydrologic Calculations and Sizing Methods

lieu of using the worksheets in Appendix B.5.2.

- If an applicant elects to perform continuous simulation, the applicant must model both the standard configuration (impervious footprint draining to a 3% biofiltration BMP) and the proposed configuration to show that proposed configuration would achieve volume reduction equal to or greater than the standard configuration. The modeling analysis must be documented in the PDP SWQMP.

### Design Assumptions:

For the footprint of non-proprietary BMPs, applicants are allowed to use the plan view area at the surface of the BMP before any ponding, when performing sizing calculations using worksheets presented in Appendix B.5.2.

One of the following two methods may also be acceptable:

- **Method 1: Effective area/effective depth method.** This method involves determining the effective depth of water stored in the BMP and identifying the effective area at that elevation. For systems with vertical walls, the effective area is simply the plan view area. For systems with side slopes, the effective area can be approximated as the plan view area inundated when the ponded depth is half full. This is the area of the contour at an elevation half way between the surface of the BMP and the overflow elevation.
- **Method 2: Area takeoff/trapezoidal method.** For more complex BMP geometries, it may be necessary to perform area takeoffs at regular contour intervals within the BMP and apply trapezoidal geometry calculations. This effectively breaks the BMP into horizontal slices. Each horizontal “slice” would have a vertical thickness, an average surface area, and an effective porosity. The product of these values is the storage volume in the slice. The sum of all slices is the total storage volume. The effective area can then be estimated by dividing the total storage volume with depth.

In both methods, volume should only be tabulated below the overflow or bypass elevation of the BMP. Surcharge or freeboard storage should not be included in calculations. When one of the above two methods are used detailed calculations must be included in the SWQMP submittal.

Area draining to the BMP must also include the area of the BMP. Use runoff factor for impervious area (i.e. concrete or asphalt) for the area of the BMP to determine the composite runoff factor for the DMA.

If an applicant performs site-specific testing using a device that has a precision of 0.1 in/hr. and determines that the measured infiltration rates in the DMA are less than 0.1 in/hr., then the applicant is allowed to size the biofiltration BMP assuming the DMA is a “No Infiltration Condition”. In instances where the actual infiltration is not measured because the testing device has a precision of 0.1 in/hr., if the applicant elects to propose a non-Standard or a compact biofiltration BMP then a reliable infiltration rate of 0.025 in/hr. must be used to size site design BMPs when there are no geotechnical

## **Appendix B: Storm Water Pollutant Control Hydrologic Calculations and Sizing Methods**

and/or groundwater hazards identified in Appendix C.

If there are geotechnical and/or groundwater hazards identified in Appendix C, then the applicant must use a reliable infiltration rate of 0.0 in/hr. for estimating the target volume retention and sizing equivalent site design BMPs.

The 36-hour drawdown percent capture nomograph that can be used to estimate the fraction of the DCV that must be retained to meet the average annual capture performance standard is presented in Figure B.5-3 below.

## Appendix B: Storm Water Pollutant Control Hydrologic Calculations and Sizing Methods

This page was intentionally left blank.

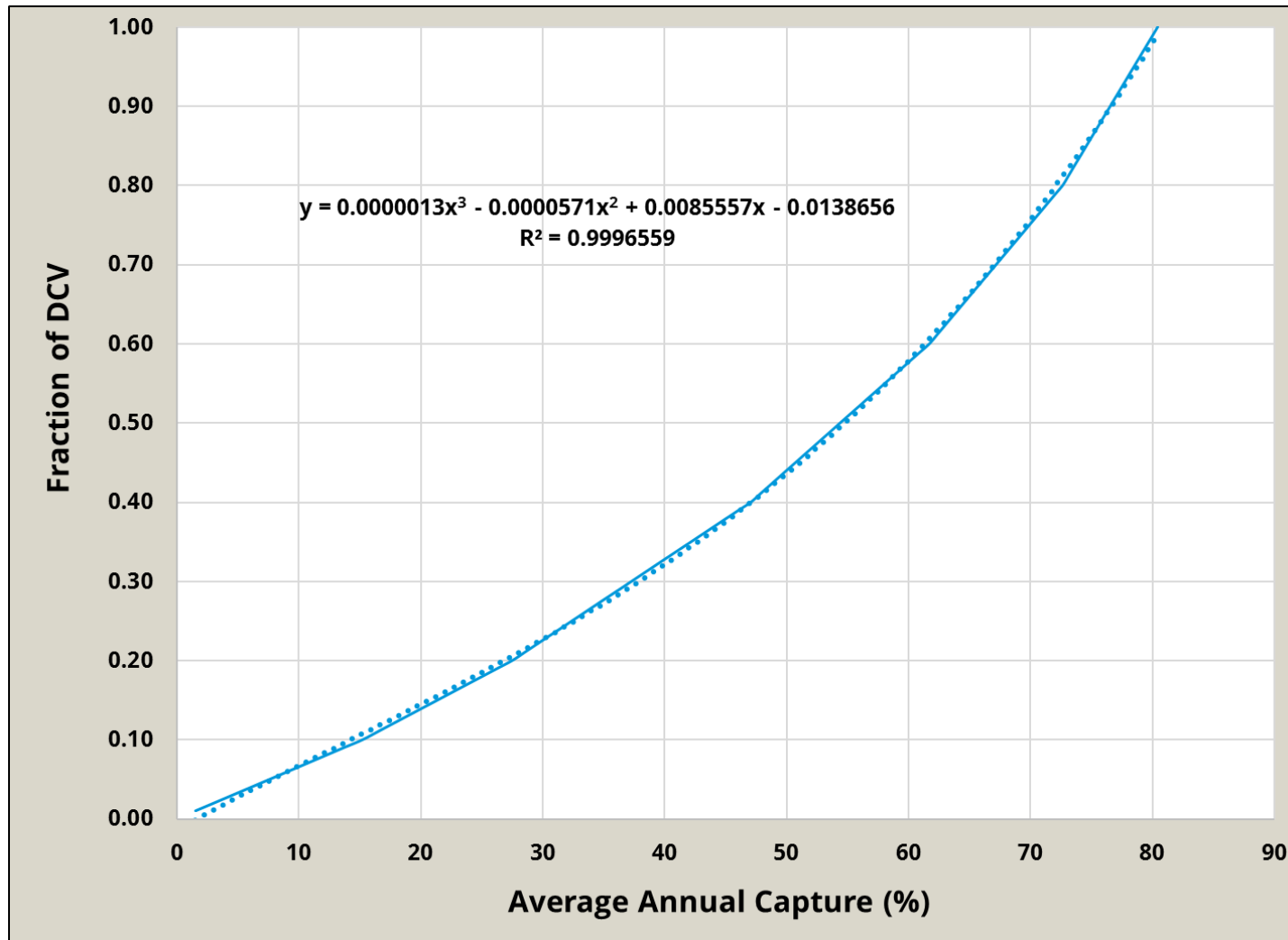

Figure B.5-3. Fraction of DCV versus Average Annual Capture

## Appendix B: Storm Water Pollutant Control Hydrologic Calculations and Sizing Methods

This page was intentionally left blank.

## Appendix B: Storm Water Pollutant Control Hydrologic Calculations and Sizing Methods

### Worksheet B.5-1: Sizing Method for Pollutant Removal Criteria

Sizing Method for Pollutant Removal Criteria			Worksheet B.5-1	
1	Area draining to the BMP			sq. ft.
2	Adjusted runoff factor for drainage area (Refer to Appendix B.1 and B.2)			
3	85 <sup>th</sup> percentile 24-hour rainfall depth			inches
4	Design capture volume [Line 1 x Line 2 x (Line 3/12)]			cu. ft.
<b>BMP Parameters</b>				
5	Surface ponding [6 inch minimum, 12 inch maximum]			inches
6	Media thickness [18 inches minimum], also add mulch layer and washed ASTM 33 fine aggregate sand thickness to this line for sizing calculations			inches
7	Aggregate storage (also add ASTM No 8 stone) above underdrain invert (12 inches typical) – use 0 inches if the aggregate is not over the entire bottom surface area			inches
8	Aggregate storage below underdrain invert (3 inches minimum) – use 0 inches if the aggregate is not over the entire bottom surface area			inches
9	Freely drained pore storage of the media	0.2		in/in
10	Porosity of aggregate storage	0.4		in/in
11	Media filtration rate to be used for sizing (maximum filtration rate of 5 in/hr. with no outlet control; if the filtration rate is controlled by the outlet use the outlet controlled rate (includes infiltration into the soil and flow rate through the outlet structure) which will be less than 5 in/hr.)			in/hr.
<b>Baseline Calculations</b>				
12	Allowable routing time for sizing	6		hours
13	Depth filtered during storm [ Line 11 x Line 12]			inches
14	Depth of Detention Storage [Line 5 + (Line 6 x Line 9) + (Line 7 x Line 10) + (Line 8 x Line 10)]			inches
15	Total Depth Treated [Line 13 + Line 14]			inches
<b>Option 1 – Biofilter 1.5 times the DCV</b>				
16	Required biofiltered volume [1.5 x Line 4]			cu. ft.
17	Required Footprint [Line 16/ Line 15] x 12			sq. ft.
<b>Option 2 - Store 0.75 of remaining DCV in pores and ponding</b>				
18	Required Storage (surface + pores) Volume [0.75 x Line 4]			cu. ft.
19	Required Footprint [Line 18/ Line 14] x 12			sq. ft.
<b>Footprint of the BMP</b>				
20	BMP Footprint Sizing Factor (Default 0.03 or an alternative minimum footprint sizing factor from Line 11 in Worksheet B.5-4)			
21	Minimum BMP Footprint [Line 1 x Line 2 x Line 20]			sq. ft.
22	Footprint of the BMP = Maximum (Minimum (Line 17, Line 19), Line 21)			sq. ft.
23	Provided BMP Footprint			sq. ft.
24	Is Line 23 ≥ Line 22?  If Yes, then footprint criterion is met. If No, increase the footprint of the BMP.		<input type="checkbox"/> Yes <input type="checkbox"/> No	



## Appendix B: Storm Water Pollutant Control Hydrologic Calculations and Sizing Methods

This page was intentionally left blank.

## Appendix B: Storm Water Pollutant Control Hydrologic Calculations and Sizing Methods

### Worksheet B.5-2: Sizing Method for Volume Retention Criteria

Sizing Method for Volume Retention Criteria		Worksheet B.5-2	
1	Area draining to the BMP		sq. ft.
2	Adjusted runoff factor for drainage area (Refer to Appendix B.1 and B.2)		
3	85 <sup>th</sup> percentile 24-hour rainfall depth		inches
4	Design capture volume [Line 1 x Line 2 x (Line 3/12)]		cu. ft.
<b>Volume Retention Requirement</b>			
5	Measured infiltration rate in the DMA  Note:  When mapped hydrologic soil groups are used enter 0.10 for NRCS Type D soils and for NRCS Type C soils enter 0.30  When in no infiltration condition and the actual measured infiltration rate is unknown enter 0.0 if there are geotechnical and/or groundwater hazards identified in Appendix C or enter 0.05	2	in/hr.
6	Factor of safety		
7	Reliable infiltration rate, for biofiltration BMP sizing [Line 5/ Line 6]		in/hr.
8	Average annual volume reduction target (Figure B.5-2)  When Line 7 > 0.01 in/hr. = Minimum (40, 166.9 x Line 7 + 6.62)  When Line 7 ≤ 0.01 in/hr. = 3.5%		%
9	Fraction of DCV to be retained (Figure B.5-3)  When Line 8 > 8% = $0.0000013 \times \text{Line } 8^3 - 0.000057 \times \text{Line } 8^2 + 0.0086 \times \text{Line } 8 - 0.014$  When Line 8 ≤ 8% = 0.023		
10	Target volume retention [Line 9 x Line 4]		cu. ft.

## Appendix B: Storm Water Pollutant Control Hydrologic Calculations and Sizing Methods

This page was intentionally left blank.

## Appendix B: Storm Water Pollutant Control Hydrologic Calculations and Sizing Methods

### Worksheet B.5-3: Volume Retention from Biofiltration with Partial Retention BMPs

Volume Retention from Biofiltration with Partial Retention BMPs		Worksheet B.5-3	
1	Area draining to the BMP		sq. ft.
2	Adjusted runoff factor for drainage area (Refer to Appendix B.1 and B.2)		
3	85 <sup>th</sup> percentile 24-hour rainfall depth		inches
4	Design capture volume [Line 1 x Line 2 x (Line 3/12)]		cu. ft.
<b>BMP Parameters</b>			
5	Footprint of the BMP		sq. ft.
6	Media thickness [18 inches minimum], also add mulch layer and washed ASTM 33 fine aggregate sand thickness to this line for sizing calculations		inches
7	Media retained pore space [50% of (Field Capacity-Wilting Point)]	0.05	in/in
8	Aggregate storage below underdrain invert (3 inches minimum) – use 0 inches if the aggregate is not over the entire bottom surface area		inches
9	Porosity of aggregate storage	0.4	in/in
10	Measured infiltration rate in the DMA  Note: When mapped hydrologic soil groups are used enter 0.10 for NRCS Type D soils and for NRCS Type C soils enter 0.30		in/hr.
11	Factor of safety	2	
12	Reliable infiltration rate, for biofiltration BMP sizing [Line 10/ Line 11]		in/hr.
<b>Evapotranspiration: Average Annual Volume Retention</b>			
13	Effective evapotranspiration depth [Line 6 x Line 7]		inches
14	Retained pore volume [(Line 13 x Line 5)/12]		cu. ft.
15	Fraction of DCV retained in pore spaces [Line 14/Line 4]		
16	Evapotranspiration average annual capture [use ET Nomographs in Figure B.5-5, Refer to Appendix B.5.4]		%
<b>Infiltration: Average Annual Volume Retention</b>			
17	Drawdown for infiltration storage [(Line 8 x Line 9)/Line 12]		hours
18	Equivalent DCV fraction from evapotranspiration (use Line 16 and Line 17 in Figure B.4-1; Refer to Appendix B.4.2.2)		
19	Infiltration volume storage [(Line 5 x Line 8 x Line 9)/12]		cu. ft.
20	Infiltration storage: Fraction of DCV [Line 19 /Line 4]		
21	Total Equivalent Fraction of DCV [Line 18 + Line 20]		
22	Biofiltration BMP average annual capture [use Line 21 and 17 in Figure B.4-1]		%
23	Fraction of DCV retained (Figure B.5-3) $0.0000013 \times \text{Line } 22^3 - 0.000057 \times \text{Line } 22^2 + 0.0086 \times \text{Line } 22 - 0.014$		
24	Volume retention achieved by biofiltration BMP [Line 23 x Line 4]		cu. ft.

## Appendix B: Storm Water Pollutant Control Hydrologic Calculations and Sizing Methods

This page was intentionally left blank.

## Appendix B: Storm Water Pollutant Control Hydrologic Calculations and Sizing Methods

### B.5.2.1 Alternative Minimum Sizing factor for Clogging Risk

Worksheet B.5-4 below must be used to support a request for an alternative minimum footprint sizing factor (for clogging) in Worksheet B.5-1. Based on a review of the submitted worksheet and supporting documentation, the use of a smaller footprint sizing factor may be approved at the discretion of the City Engineer. If approved, the estimated footprint from the worksheet below can be used in line 20 of Worksheet B.5-1 in lieu of the 3 percent minimum footprint value.

This worksheet includes the following general steps to calculate the minimum footprint sizing factor:

- Select a “load to clog” that is representative of the type of BMP proposed
- Select a target life span (i.e., frequency of major maintenance) that is acceptable to the City Engineer. A default value of 10 years is recommended.
- Compile information about the DMA from other parts of the SWQMP development process.
- Determine the event mean concentration (EMC) of TSS that is appropriate for the DMA
- Perform calculations to determine the minimum footprint to provide the target lifespan.

**Table B.5-3: Typical land use total suspended solids (TSS) event mean concentration (EMC) values.**

Land Use	TSS EMC <sup>4</sup> , mg/L
Single Family Residential	123
Commercial	128
Industrial	125
Education (Municipal)	132
Transportation <sup>5</sup>	78
Multi-family Residential	40
Roof Runoff <sup>6</sup>	14
Low Traffic Areas <sup>7</sup>	50
Open Space	216

---

<sup>4</sup> EMCs are from SBPAT datasets for SLR and SDR Watersheds – Arithmetic Estimates of the Lognormal Summary Statistics for San Diego, unless otherwise noted.

<sup>5</sup> EMCs are based on Los Angeles region default SBPAT datasets due to lack of available San Diego data.

<sup>6</sup> Value represents the average first flush concentration for roof runoff (Charters et al., 2015).

<sup>7</sup> Davis and McCuen (2005)

## Appendix B: Storm Water Pollutant Control Hydrologic Calculations and Sizing Methods

**Table B.5-4: Guidance for Selecting Load to Clog (LC)**

BMP Configuration	Load to Clog, $L_c$ , lb/sq-ft
<b>Baseline: Approximately 50 percent vegetative cover; typical fine sand and compost blend</b>	2
<b>Baseline + increase vegetative cover to at least 75 percent</b>	3
<b>Baseline + include coarser sand to increase initial permeability to 20 to 30 in/hr; control flowrate with outlet control</b>	3
<b>Baseline + increase vegetative cover and include more permeable media with outlet control, per above</b>	4

### References

Charters, F.J., Cochrane, T.A., and O’Sullivan, A.D., (2015). Particle Size Distribution Variance in Untreated Urban Runoff and its implication on treatment selection. *Water Research*, 85 (2015), pg. 337-345.

Davis, A.P. and McCuen, R.H., (2005). *Stormwater Management for Smart Growth*. Springer Science & Business Media, pg. 155.

Maniquiz-Redillas, M.C., Geronimo, F.K.F, and Kim, L-H. Investigation on the Effectiveness of Pretreatment in Stormwater Management Technologies. *Journal of Environmental Sciences*, 26 (2014), pg. 1824-1830.

Pitt, R. and Clark, S.E., (2010). *Evaluation of Biofiltration Media for Engineered Natural Treatment Systems*. Geosyntec Consultants and The Boeing Company.

## Appendix B: Storm Water Pollutant Control Hydrologic Calculations and Sizing Methods

### Worksheet B.5-4: Calculation of Alternative Minimum Footprint Sizing Factor for Non-Standard Biofiltration

Alternative Minimum Footprint Sizing Factor for Non-Standard Biofiltration		Worksheet B.5-4	
1	Area draining to the BMP		sq. ft.
2	Adjusted Runoff Factor for drainage area (Refer to Appendix B.1 and B.2)		
3	Load to Clog (default value when using Appendix E fact sheets is 2.0)		lb/sq. ft.
4	Allowable Period to Accumulate Clogging Load (T <sub>i</sub> ) (default value is 10)		years
<b>Volume Weighted EMC Calculation</b>			
Land Use	Fraction of Total DCV	TSS EMC (mg/L)	Product
Single Family Residential		123	
Commercial		128	
Industrial		125	
Education (Municipal)		132	
Transportation		78	
Multi-family Residential		40	
Roof Runoff		14	
Low Traffic Areas		50	
Open Space		216	
Other, specify:			
Other, specify:			
Other, specify:			
5	Volume Weighted EMC (sum of all products)		mg/L
<b>Sizing Factor for Clogging</b>			
6	Adjustment for pretreatment measures Where: Line 6 = 0 if no pretreatment; Line 6 = 0.25 when pretreatment is included; Line 6 = 0.5 if the pretreatment has an active Washington State TAPE approval rating for “pre-treatment.”		
7	Average Annual Precipitation [Provide documentation of the data source in the discussion box; SanGIS has a GIS layer for average annual precipitation]		inches
8	Calculate the Average Annual Runoff (Line 7/12) x Line 1 x Line 2		cu-ft/yr
9	Calculate the Average Annual TSS Load (Line 8 x 62.4 x Line 5 x (1 – Line 6))/10 <sup>6</sup>		lb/yr
10	Calculate the BMP Footprint Needed (Line 9 x Line 4)/Line 3		sq. ft.
11	Calculate the Minimum Footprint Sizing Factor for Clogging [Line 10/ (Line 1 x Line 2)]		
Discussion:			



This page was intentionally left blank.

## Appendix B: Storm Water Pollutant Control Hydrologic Calculations and Sizing Methods

### B.5.2.2 Sizing Biofiltration BMPs Downstream of a Storage Unit

#### Introduction

In scenarios, where the BMP footprint is governed based on Option 1 (Line 17 of Worksheet B.5-1) or the required volume reduction for partial infiltration conditions (Line 10 of Worksheet B.5-2) the footprint of the biofiltration BMP can be reduced using the sizing calculations in this Appendix B.5.2.2 when there is an upstream storage unit (e.g. cistern) that can be used to regulate the flows through the biofiltration BMP.

When this approach is used for sizing biofiltration BMPs the applicant must also verify that the storage unit meets the hydromodification management drawdown requirements and the discharge from the downstream biofiltration BMP will still meet the hydromodification flow control requirements. These calculations must be documented in the PDP SWQMP.

This methodology is **not** applicable when the minimum footprint factor is governed based on the alternative minimum footprint sizing factor calculated using Worksheet B.5-4 (Line 11). A biofiltration BMP smaller than the alternative minimum footprint sizing factor is considered compact biofiltration BMP and may be allowed at the discretion of the City Engineer if the BMP meets the requirements in Appendix F **and** the applicant submits a completed Form I-10.

#### Sizing Calculation

Sizing calculations for the biofiltration footprint must demonstrate that one of the following two equivalent performance standards is met:

1. Use continuous simulation and demonstrate the following is met:
  - (a) The BMP or series of BMPs biofilters at least 92 percent of average annual (long term) runoff volume and achieves a volume reduction equivalent to Line 10 of Worksheet B.5-2. This can be demonstrated through reporting of output from the San Diego Hydrology Model, or through other continuous simulation modeling meeting the criteria in Appendix G, as acceptable to the City Engineer. The 92 percent of average annual runoff treatment corresponds to the average capture achieved by implementing a BMP with 1.5 times the DCV and a drawdown time of 36 hours (Appendix B.4.2).
2. Use the simple optimized method in Worksheet B.5-5. The applicant is also required to complete Worksheet B.5-1, B.5-2 and B.5-4 when the applicant elects to use Worksheet B.5-5 to reduce the biofiltration BMP footprint. Worksheet B.5-5 was developed to satisfy the following two criteria as applicable:
  - (a) Greater than 92 percent of the average annual runoff volume from the storage unit is routed to the biofiltration BMP through the low flow orifice and the peak flow from the low flow orifice can instantaneously be filtered through the biofiltration media. If the outlet design for the storage unit includes orifices at different elevations and an overflow structure, only flows from the overflow structure should be excluded from the calculation (both for 92 percent capture and for peak flow to the biofiltration BMP that

## Appendix B: Storm Water Pollutant Control Hydrologic Calculations and Sizing Methods

needs to be instantaneously filtered), unless the flows from other orifices also bypass the biofiltration BMP, in which case flows from the orifices that bypass should also be excluded.

- (b) The retention losses from the optimized biofiltration BMP are equal to or greater than the retention losses from the conventional biofiltration BMP. This second criterion is only applicable for partial infiltration condition.

For drawdown times that are outside the range of values presented in Table B.5-5 below, the storage unit should be designed to discharge greater than 92% average annual capture to the downstream Biofiltration BMP.

**Table B.5-5: Storage Required for Different Drawdown Times**

Drawdown Time (hours)	Storage requirement (below the overflow elevation, or below outlet elevation that bypass the biofiltration BMP)
12	0.85 DCV
24	1.25 DCV
36	1.50 DCV
48	1.80 DCV
72	2.20 DCV
96	2.60 DCV
120	2.80 DCV

## Appendix B: Storm Water Pollutant Control Hydrologic Calculations and Sizing Methods

**Worksheet B.5-5: Optimized Biofiltration BMP Footprint when Downstream of a Storage Unit**

Optimized Biofiltration BMP Footprint when Downstream of a Storage Unit		Worksheet B.5-5	
1	Area draining to the storage unit and biofiltration BMP		sq. ft.
2	Adjusted runoff factor for drainage area (Refer to Appendix B.1 and B.2)		
3	Effective impervious area draining to the storage unit and biofiltration BMP [Line 1 x Line 2]		sq. ft.
4	Remaining DCV after implementing retention BMPs		cu. ft.
5	Design infiltration rate (measured infiltration rate / 2)		ft./hr.
6	Media Thickness [1.5 feet minimum], also add mulch layer and washed ASTM 33 fine aggregate sand thickness to this line for sizing calculations		ft.
7	Media filtration rate to be used for sizing (0.42 ft/hr. with no outlet control; if the filtration rate is controlled by the outlet use the outlet controlled rate)		ft./hr.
8	Media retained pore space	0.05	in./in.
<b>Storage Unit Requirement</b>			
9	Drawdown time of the storage unit, minimum (from the elevation that bypasses the biofiltration BMP, overflow elevation)		hours
10	Storage required to achieve greater than 92 percent capture (see Table B.5-5)		fraction
11	Storage required in cubic feet (Line 4 x Line 10)		cu. ft.
12	Storage provided in the design, minimum (from the elevation that bypasses the biofiltration BMP, overflow elevation)		cu. ft.
13	Is Line 12 $\geq$ Line 11. If no increase storage provided until this criteria is met	<input type="checkbox"/> Yes <input type="checkbox"/> No	
<b>Criteria 1: BMP Footprint Biofiltration Capacity</b>			
14	Peak flow from the storage unit to the biofiltration BMP (using the elevation used to evaluate the percent capture)		cfs
15	Required biofiltration footprint [(3,600 x Line 14)/Line 7]		sq. ft.
<b>Criteria 2: Alternative Minimum Sizing Factor (Clogging)</b>			
16	Alternative Minimum Footprint Sizing Factor [Line 11 of Worksheet B.5-4]		Fraction
17	Required biofiltration footprint [Line 3 x Line 16]		sq. ft.
<b>Criteria 3: Retention requirement [Not applicable for No Infiltration Condition]</b>			
18	Retention Target (Line 10 in Worksheet B.5-2)		cu. ft.
19	Average discharge rate from the storage unit to the biofiltration BMP		cfs
20	Depth retained in the optimized biofiltration BMP {Line 6 x Line 8} + {(Line 4)/(2400 x Line 19)} x Line 5}		ft.
21	Required optimized biofiltration footprint (Line 18/Line 20)		sq. ft.
<b>Optimized Biofiltration Footprint</b>			
22	Optimized biofiltration footprint, maximum (Line 15, Line 17, Line 21)		sq. ft.

**Appendix B: Storm Water Pollutant Control Hydrologic Calculations and Sizing Methods**

This page was intentionally left blank.

## Appendix B: Storm Water Pollutant Control Hydrologic Calculations and Sizing Methods

### Worksheet B.5-6: Volume Retention for No Infiltration Condition

Volume Retention for No Infiltration Condition				Worksheet B.5-6		
1	Area draining to the biofiltration BMP					sq. ft.
2	Adjusted runoff factor for drainage area (Refer to Appendix B.1 and B.2)					
3	Effective impervious area draining to the BMP [Line 1 x Line 2]					sq. ft.
4	Required area for Evapotranspiration [Line 3 x 0.03]					sq. ft.
5	Biofiltration BMP Footprint					sq. ft.
<b>Landscape Area (must be identified on DS-3247)</b>						
	<b>Identification</b>	<b>A</b>	<b>B</b>	<b>C</b>	<b>D</b>	<b>E</b>
6	Landscape area that meet the requirements in SD-B and SD-F Fact Sheet (sq. ft.)					
7	Impervious area draining to the landscape area (sq. ft.)					
8	Impervious to Pervious Area ratio [Line 7/Line 6]					
9	Effective Credit Area If Line 8 > 1.5, use Line 6; if not use Line 7/1.5					
10	Sum of Landscape area [sum of Lines 9A-9E]					sq. ft.
11	Provided footprint for evapotranspiration [Line 5 + Line 10]					sq. ft.
<b>Volume Retention Performance Standard</b>						
12	Is Line 11 $\geq$ Line 4? If yes, then volume retention performance standard for no infiltration condition is met. If no, proceed to Line 13				<input type="checkbox"/> Yes <input type="checkbox"/> No	
13	Fraction of the performance standard met through the BMP footprint and/or landscaping [Line 11/Line 4]					
14	Target Volume Retention [Line 10 from Worksheet B.5.2]					cu. ft.
15	Volume retention required from other site design BMPs [(1-Line 13) x Line 14]					cu. ft.
<b>Site Design BMP</b>						
	<b>Identification</b>	<b>Site Design Type</b>			<b>Credit</b>	
16	<b>A</b>					cu. ft.
	<b>B</b>					cu. ft.
	<b>C</b>					cu. ft.
	<b>D</b>					cu. ft.
	<b>E</b>					cu. ft.
	Sum of volume retention benefits from other site design BMPs (e.g. trees; rain barrels etc.). [sum of Lines 16A-16E] Provide documentation of how the site design credit is calculated in the PDP SWQMP.					cu. ft.
17	Is Line 16 $\geq$ Line 15? If yes, then volume retention performance standard for no infiltration condition is met. If no, implement additional site design BMPs.				<input type="checkbox"/> Yes <input type="checkbox"/> No	

## Appendix B: Storm Water Pollutant Control Hydrologic Calculations and Sizing Methods

This page was intentionally left blank.

## Appendix B: Storm Water Pollutant Control Hydrologic Calculations and Sizing Methods

### Worksheet B.5-7: Volume Retention from Amended Soils

Volume Retention From Amended Soils		Worksheet B.5-7	
1	Impervious area draining to the pervious area		sq. ft.
2	Pervious area (must meet the requirements in SD-B and SD-F Fact Sheets)		sq. ft.
3	Dispersion Ratio [Line 1/Line 2] Note: This worksheet is not applicable when Line 3 > 50 or Line 3 < 0.25		
4	Adjusted runoff factor [(Line 1 * 0.9 + Line 2 * 0.1) / (Line 1 + Line 2)]		
5	85 <sup>th</sup> percentile 24-hour rainfall depth		inches
6	Design capture volume [(Line 1 + Line 2) x Line 4 x (Line 5/12)]		cu. ft.
7	Amendment Depth (Choose from 3", 6", 9", 12", 15" and 18")		inches
8	Storage [(porosity – field capacity) + 0.5 * (field capacity – wilting point)]	0.25	in./in.
9	Pervious Storage [Line 2 * (Line 7/12) * Line 8]		cu. ft.
10	Fraction of DCV [Line 9 / Line 6]		
11	Measured Infiltration Rate  When mapped hydrologic soil groups are used enter 0.10 for NRCS Type D soils and for NRCS Type C soils enter 0.30  When in no infiltration condition and the actual measured infiltration rate is unknown enter 0.0 if there are geotechnical and/or groundwater hazards identified in Appendix C or enter 0.05		in/hr.
12	Factor of Safety	2	
13	Reliable Infiltration Rate [Line 11/Line 12]		in/hr.
14	Dispersion Credit (Based on Figures B.5.6 to B.5.11; Line 10 and Line 13)		
15	Volume retention due to amendment [Line 1 * (Line 5/12) * Line 14]		cu. ft.

The following criteria must be met to get volume reduction credit from amended soils:

- Pervious area must not have an underdrain;
- If pervious area has an impermeable liner, the applicant must use 0.000001 in/hr. for reliable infiltration rate;
- Impervious area must be dispersed uniformly across the pervious area and at non-erosive velocities;
- Pervious area must have a minimum width of 10 feet (exemption to this minimum width criterion is allowed when the contributing flow path length of the impervious area /pervious area width ≤ 2) and a maximum slope of 5%; **and**
- Impervious to pervious area ratio must be less than 50:1.

The applicants have an option to deviate from the criteria listed above, in this case the applicant must perform site specific continuous simulation modeling (following guidelines in Appendix G) to estimate the volume retention benefits from the amended soils and document the analysis in the PDP SWQMP.



## Appendix B: Storm Water Pollutant Control Hydrologic Calculations and Sizing Methods

This page was intentionally left blank.

## Appendix B: Storm Water Pollutant Control Hydrologic Calculations and Sizing Methods

### B.5.3 Basis for Minimum Sizing Factor for Biofiltration BMPs

#### B.5.3.1 Introduction

##### *MS4 Permit Provision E.3.c.(1)(a)(i)*

The MS4 Permit describes conceptual performance goals for biofiltration BMPs and specifies numeric criteria for sizing biofiltration BMPs (See Section 2.2.1 of this Manual).

However, the MS4 Permit does not define a specific footprint sizing factor or design profile that must be provided for the BMP to be considered “biofiltration.” Rather, the MS4 Permit specifies (Footnote 29):

**As part of the Copermittee’s update to its BMP Design Manual, pursuant to Provision E.3.d, the Copermittee must provide guidance for hydraulic loading rates and other biofiltration design criteria necessary to maximize storm water retention and pollutant removal.**

To meet this provision, this manual includes specific criteria for design of biofiltration BMPs. Among other criteria, a minimum footprint sizing factor of 3 percent (BMP footprint area as percent of contributing area times adjusted runoff factor) and a volume retention performance standard (Figure B.5-2) based on the reliable infiltration rate at the site (i.e. measured infiltration rate/2) is specified. The purpose of this section is to provide the technical rationale for this 3 percent minimum sizing factor and the volume retention performance standard.

#### B.5.3.2 Conceptual Need for Minimum Sizing Factor

Under the 2011 Model SUSMP, a sizing factor of 4 percent was used for sizing biofiltration BMPs. This value was derived based on the goal of treating the runoff from a 0.2 inch per hour uniform precipitation intensity at a constant media flow rate of 5 inches per hour. While this method was simple, it was considered to be conservative as it did not account for significant transient storage present in biofiltration BMPs (i.e., volume in surface storage and subsurface storage that would need to fill before overflow occurred). Under this manual, biofiltration BMPs will typically provide subsurface storage to promote infiltration losses; therefore typical BMP profiles will tend to be somewhat deeper than those provided under the 2011 Model SUSMP. A deeper profile will tend to provide more transient storage and allow smaller footprint sizing factors while still providing similar or better treatment capacity and pollutant removal. Therefore, a reduction in the minimum sizing factor from the factor used in the 2011 Model SUSMP is supportable. However, as footprint decreases, issues related to potential performance, operations, and/or maintenance can increase for a number of reasons:

1. As the surface area of the media bed decreases, the sediment loading per unit area increases, increasing the risk of clogging. While vigorous plant growth can help maintain permeability of soil, there is a conceptual limit above which plants may not be able to mitigate for the sediment loading. Scientific knowledge is not conclusive in this area.

## **Appendix B: Storm Water Pollutant Control Hydrologic Calculations and Sizing Methods**

2. With smaller surface areas and greater potential for clogging, water may be more likely to bypass the system via overflow before filling up the profile of the BMP.
3. As the footprint of the system decreases, the amount of water that can be infiltrated from subsurface storage layers and evapotranspire from plants and soils tends to decrease.
4. With smaller sizing factors, the hydraulic loading per unit area increases, potentially reducing the average contact time of water in the soil media and diminishing treatment performance.

The MS4 Permit requires that volume and pollutant retention be maximized. Therefore, a minimum sizing factor was determined to be needed. This minimum sizing factor does not replace the need to conduct sizing calculations as described in this manual; rather it establishes a lower limit on required size of biofiltration BMPs as the last step in these calculations. Additionally, it does not apply to alternative biofiltration designs that utilize the checklist in Appendix F (Biofiltration Standard and Checklist). Acceptable alternative designs (such as proprietary systems meeting Appendix F criteria) typically include design features intended to allow acceptable performance with a smaller footprint and have undergone field scale testing to evaluate performance and required O&M frequency.

### **B.5.3.3 Lines of Evidence to Select Minimum Sizing Factor**

Three primary lines of evidence were used to select the minimum sizing factor of 3 percent (BMP footprint area as percent of contributing area times adjusted runoff factor) in this manual:

1. Typical design calculations.
2. Volume reduction performance.
3. Sediment clogging calculations.

These lines of evidence and associated findings are explained below.

#### Typical Design Calculations

A range of BMP profiles were evaluated for different design rainfall depths and soil conditions. Worksheet B.5-1 was used for each case to compute the required footprint sizing factor. For these calculations, the amount of water filtered during the storm event was determined based on a media filtration rate of 5 inches per hour and a routing time of 6 hours. These input assumptions are considered to be well-supported and consistent with the intent of the MS4 Permit. These calculations generally yielded footprint sizing factors between 1.5 and 4.9 percent. In the interest of establishing a uniform County-wide minimum sizing factor, a 3 percent sizing factor was selected from this range, consistent with other lines of evidence.

#### Volume Reduction Performance

Consistent with guidance in Fact Sheet PR-1, the amount of retention storage (in gravel sump below underdrain) that would drain in 36 hours was calculated for a range of soil types. This was used to

## Appendix B: Storm Water Pollutant Control Hydrologic Calculations and Sizing Methods

estimate the volume reduction that would be expected to be achieved. For a sizing factor of 3 percent and a soil filtration rate of 0.20 inches per hour (NRCS Type B Soils, moderate infiltration rates), the average annual volume reduction was estimated to be approximately 40 percent (via percent capture method; see Appendix B.4.2).

In describing the basis for equivalency between retention and biofiltration (1.5 multiplier), the MS4 Permit Fact Sheet referred to analysis prepared in the Ventura County Technical Guidance Manual. The Ventura County analysis considered the pollutant treatment as well as the volume reduction provided by biofiltration in considering equivalency to retention. This analysis assumed an average long term volume reduction of 40 percent based on analysis of data from the International Stormwater BMP Database. The calculations of estimated volume reduction at a 3 percent sizing factor is (previous paragraph) consistent with this value. While estimated volume reduction is sensitive to site-specific factors, this analysis suggests that a sizing factor of approximately 3 percent provides levels of volume reduction that are reasonably consistent with the intent of the MS4 Permit.

### Volume Retention Performance Standard

The volume retention performance standard in Figure B.5-2 was developed to allow for adjustment of the volume retention requirement based on the type of soils present onsite. Constrained sites with poorly draining soils may not be able to install BMPs having a sufficient footprint to satisfy 40% retention performance standard. As such, a sliding scale was developed to adjust the performance standard to match the ability of the site to infiltrate. In effect, the sliding scale produces similar BMP footprint sizes across a varying range of infiltration rates (up to 0.20 inches per hour) for a given 85<sup>th</sup> percentile 24-hour storm depth.

The “sliding scale” portion (i.e. the sloped portion of the line) of the performance standard indicated in Figure B.5-2 was determined by estimating the retention associated with a very low infiltration rate (effectively the Y-axis intercept) and then connecting that point to the unadjusted performance standard (0.2 in/hr. infiltration rate, 40% average annual retention) with a straight line. The unadjusted performance standard is based on a 3% BMP footprint size factor and results in a rainfall depth of approximately 0.74 inches. Fixing this rainfall depth and using the same 3% BMP footprint factor, the feasible retention associated with an infiltration rate of 0.01 inches per hour (very low) was estimated using the drawdown percent capture curves presented in Figure B.4-1 and ET percent capture curves presented in Figure B.5-5. The resulting retention was estimated to be 8.3% (for 0.01 in/hr. infiltration rate), which became the starting point of the line that then connects to the unadjusted performance standard (0.2 in/hr., 40% retention). The resulting performance standard curve allows flexibility in the design of BMPs or site design features while ensuring consistent performance within the City.

### Sediment Clogging Calculations

As sediment accumulates in a filter, the permeability of the filter tends to decline. The lifespan of the filter bed can be estimated by determining the rate of sediment loading per unit area of the filter bed. To determine the media bed surface area sizing factor needed to provide a target lifespan, simple

## Appendix B: Storm Water Pollutant Control Hydrologic Calculations and Sizing Methods

sediment loading calculations were conducted based on typical urban conditions. The inputs and results of this calculation are summarized in Table B.5-6.

**Table B.5-6: Inputs and Results of Clogging Calculation**

Parameter	Value	Source
<b>Representative TSS Event Mean Concentration, mg/L</b>	100	Approximate average of San Diego Land Use Event Mean Concentrations from San Diego River and San Luis Rey River WQIP
<b>Runoff Coefficient of Impervious Surface</b>	0.90	Table B.1-1
<b>Runoff Coefficient of Pervious Surface</b>	0.10	Table B.1-1 for landscape areas
<b>Imperviousness</b>	40% to 90%	Planning level assumption, covers typical range of single family to commercial land uses
<b>Average Annual Precipitation, inches</b>	11 to 13	Typical range for much of urbanized San Diego County
<b>Load to Initial Maintenance, kg/m<sup>2</sup></b>	10	Pitt, R. and S. Clark, 2010. Evaluation of Biofiltration Media for Engineered Natural Treatment Systems.
<b>Allowable period to initial clogging, yr</b>	10	Planning-level assumption
<b>Estimated BMP Footprint Needed for 10-Year Design Life</b>	2.8% to 3.3%	Calculated

This analysis suggests that a 3 percent sizing factor, coupled with sediment source controls and careful system design, should provide reasonable protection against premature clogging. However, there is substantial uncertainty in sediment loading and the actual load to clog that will be observed under field conditions in the San Diego climate. Additionally, this analysis did not account for the effect of plants on maintaining soil permeability. Therefore, this line of evidence should be considered provisional, subject to refinement based on field scale experience. As field scale experience is gained about the lifespan of biofiltration BMPs in San Diego and the mitigating effects of plants on long term clogging, it may be possible to justify lower factors of safety and therefore smaller design sizes in some cases. If a longer lifespan is desired and/or greater sediment load is expected, then a larger sizing factor may be justified.

### B.5.3.4 Discussion

Generally, the purpose of a minimum sizing factor is to help improve the performance and reliability of standard biofiltration systems and limit the use of sizing methods and assumptions that may lead to designs that are less consistent with the intent of the MS4 Permit.

Ultimately, this factor is a surrogate for a variety of design considerations, including clogging and associated hydraulic capacity, volume reduction potential, and treatment contact time. A prudent design approach should consider each of these factors on a project-specific basis and identify whether site conditions warrant a larger or smaller factor. For example, a system treating only rooftop runoff in an area without any allowable infiltration may have negligible clogging risk and negligible volume

## **Appendix B: Storm Water Pollutant Control Hydrologic Calculations and Sizing Methods**

reduction potential – a smaller sizing factor may not substantially reduce performance in either of these areas. Alternatively, for a site with high sediment load and limited pre-treatment potential, a larger sizing factor may be warranted to help mitigate potential clogging risks. The City Engineer has discretion to accept alternative sizing factor(s) based on project-specific considerations. Additionally, the recommended minimum sizing factor may change over time as more experience with biofiltration is obtained.

### **B.5.4 Volume Retention Mechanisms**

A series of nomographs were developed using United States Environmental Protection Agency (USEPA) SWMM and parameters listed in Appendix G for the Lake Wohlford rain gage and presented in this Appendix B.5.4 to provide applicants tools to quantify volume retention achieved by a BMP and/or a site design feature that is implemented at the project site.

#### **B.5.4.1 Technical Framework**

The total amount of volume retention (reduction) achieved through a BMP and/or site design feature is a function of the amount of water that enters the BMP and/or a site design feature and does not immediately overflow (i.e., the amount of water that is captured), and the portion of the captured water that is “lost” via infiltration, evapotranspiration, and/or consumptive use (i.e., the total of all three is the volume reduction), such that it does not discharge directly to surface water.

When evaluating volume retention and capture efficiency, each BMP and/or site design can be considered to consist of a set of storage compartments, each with a distinct storage volume, discharge rate, and pathway by which water discharges (i.e., surface discharge, infiltration, evapotranspiration). Figure B.5-4 illustrates this concept. When storage capacity is available in a given compartment, then that compartment of the BMP and/or site design can capture additional inflow. When storage capacity is not available in a given compartment to accept additional inflow, then inflowing water either fills the next storage compartment of the BMP and/or site design, or bypasses the system (if no additional storage is available). The volume retention and capture performance of a BMP and/or site design is primarily a function of the amount of storage volume provided and the rate at which the storage drains to volume retention pathways (i.e., infiltration, evapotranspiration, consumptive use) versus surface discharge pathways.

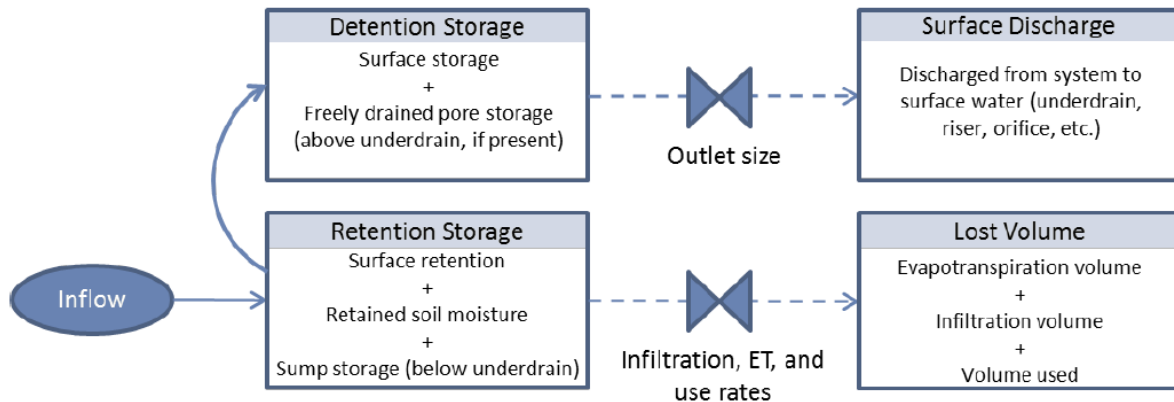

Figure B.5-4. Schematic Representation for Purpose of Volume Retention Analysis

Capture efficiency (or “percent capture”) is a metric that measures the percent of rainfall that is captured and managed by a BMP and/or a site design feature (i.e., does not bypass or immediately overflow). Captured storm water may be infiltrated, evapotranspired, or retained for harvest and use, and/or treated and released. Capture efficiency is typically expressed as annual average percent capture. Runoff volume that is not captured by a BMP and/or site design feature is referred to as bypass or overflow. Volume reduction processes can only occur in a BMP and/or site design feature when water is captured.

Long term capture efficiency is primarily a function of the BMP and/or site design feature storage volume (relative to the size and the DCV of the DMA), the drawdown rate and pattern of the storage compartment, and rainfall pattern. Practically, this means that the following parameters can be isolated as primary predictors of capture efficiency for the purpose of developing an approximate predictive tool:

- **Normalized storage volume**, expressed as a fraction of DCV. For example, a 1,000 cubic foot storage volume for a watershed that is 1 acre with a runoff coefficient of 0.9 and an 85<sup>th</sup> percentile rainfall depth of 0.6 inches would translate to 0.51 times the DCV [ $1,000 \text{ cu-ft} \times 12 \text{ in/ft.} / (1 \text{ ac} \times 43,560 \text{ sq-ft/ac} \times 0.9 \times 0.6 \text{ in})$ ].
- **Drawdown time of the storage volume**. For BMP and/or site design feature storage elements with nominally consistent drawdown rates regardless of season (i.e., infiltration, filtration, orifice-controlled surface discharge), the representative drawdown time can be expressed in hours. For example, a bioretention area with an effective storage depth of 12 inches and an underlying design infiltration rate of 0.2 inches per hour would have a nominal drawdown time of 60 hours (12 inches / 0.2 in/hr.). For BMP and/or site design feature

## Appendix B: Storm Water Pollutant Control Hydrologic Calculations and Sizing Methods

storage elements with seasonally varying drawdown rates (i.e., storage drained by evapotranspiration or irrigation-based consumptive use), the concept of a representative drawdown time is not applicable. In this case, the evapotranspiration storage depth (i.e., the amount of potential evapotranspiration that must occur for the stored water to empty) is a more appropriate indicator of how quickly storage is recovered and can be used (along with climate data input to the model) as a predictor of long term capture efficiency.

By isolating these two most important predictive variables, a limited number of continuous simulation model runs and associated results can be used to describe the expected long term performance of a wide range of BMP and/or site design types and configurations. For example, the results of a long term model simulation for a 0.5xDCV storage with 48-hour drawdown would be representative of a wide range of different BMP and/or site design configurations. The two examples would both be reliably represented by this single model run.

- **Example 1:** 10,000 cu-ft infiltration basin draining 10.2 acres of pavement (equates to 0.5DCV when 85<sup>th</sup> percentile rainfall is 0.6 inches), with 3-foot ponding depth and a design infiltration rate of 0.75 inches per hour (equates to 48-hour drawdown time).
- **Example 2:** 300 cu-ft of aggregate storage volume below the underdrain invert in a biofiltration with partial retention BMP with a tributary area of 0.367 acres of pavement (equates to 0.5DCV when 85<sup>th</sup> percentile rainfall is 0.5 inches), with an effective depth of 6 inches and a design infiltration rate of 0.125 in/hr. (equates to 48-hour drawdown time).

It can be seen that an infinite number of potential design combinations could be reflected by this single model run.

### B.5.4.2 Modeling Methodology and Results

Three sets of continuous simulation runs were executed in the EPA SWMM using the default parameters in Appendix G and the Lake Wohlford rain gage to develop the nomographs that can be used to estimate the volume retention benefits from BMPs and/or site design BMPs.

- **Consistent drawdown runs:** Consistent drawdown runs were used to represent BMPs and/or site design elements that can be approximated as draining at a relatively consistent rate throughout a long term continuous simulation (e.g., infiltration, media filtration, orifice discharge). The template model setup developed for these runs included a tributary subcatchment draining to a storage unit of a given size (varied between runs) modeled with a drawdown rate (varied between runs) that was held constant throughout each simulation. Continuous rainfall-runoff processes were simulated to estimate the continuous runoff hydrograph. Routing through the storage unit was simulated to estimate the long term capture efficiency associated with the given configuration. The results from these runs are presented in Figure B.4-1 in Appendix B.4.2.



## Appendix B: Storm Water Pollutant Control Hydrologic Calculations and Sizing Methods

- **Evapotranspiration drawdown runs:** Evapotranspiration runs were used to represent BMPs and/or site design elements that drain via evapotranspiration processes, at rates that inherently vary with climatic factors throughout the year. The template model setup developed for these runs included a tributary subcatchment draining to a storage unit of a given size (varied between runs) modeled with a given stored water depth (varied between runs) that was drawn down at the applied evapotranspiration rate (varies on a monthly basis). Continuous rainfall-runoff processes were simulated to estimate the continuous runoff hydrograph. Routing through the storage unit was simulated to estimate the long term evapotranspiration loss associated with the given configuration. Results from these runs are presented in Figure B.5-5.

**Dispersion runs:** Dispersion runs were used to represent site design elements that cannot be simply divided into different storage units because water is dispersed in a thin layer and is acted upon by both infiltration and evapotranspiration processes. The template model setup developed for these runs included a tributary subcatchment draining to two broad, shallow storage units in series (area varied between runs to represent different proportions of pervious area receiving dispersion). The first storage unit was used to represent water stored in the “suction storage” of soil pores that did not freely drain via gravity. This was filled first and was drawn down at the rate established by evapotranspiration inputs. This storage unit also received flow from a “dummy catchment” with 100 percent imperviousness and zero depression storage; effectively representing precipitation directly on the dispersion area. The second storage unit had the same footprint as the first storage unit (i.e., equal to the size of the dispersion area) and received flow when the first storage unit overflowed. These storage units were effectively “stacked” in the model. This storage unit represented the freely drained pore storage (i.e., drained by gravity) in the amended media and any surface ponding in closed depressions. This storage unit was drained via Green-Ampt infiltration processes based on the assigned infiltration parameters (varied between runs). The depth of stored water in the first and second storage compartments was calculated based on the assumed depth of soil amendments (varied between runs) and typical amended soil properties. Continuous rainfall-runoff processes were simulated to estimate the runoff hydrograph. Routing through the storage units was simulated to estimate the long-term capture efficiency and the dispersion credit for the impervious area associated with the given configuration. Results from these runs are presented in Figure B.5-6 (3” amendment); Figure B.5-7 (6” amendment); Figure B.5-8 (9” amendment); Figure B.5-9 (12” amendment); Figure B.5-10 (15” amendment) and Figure B.5-11 (18” amendment).

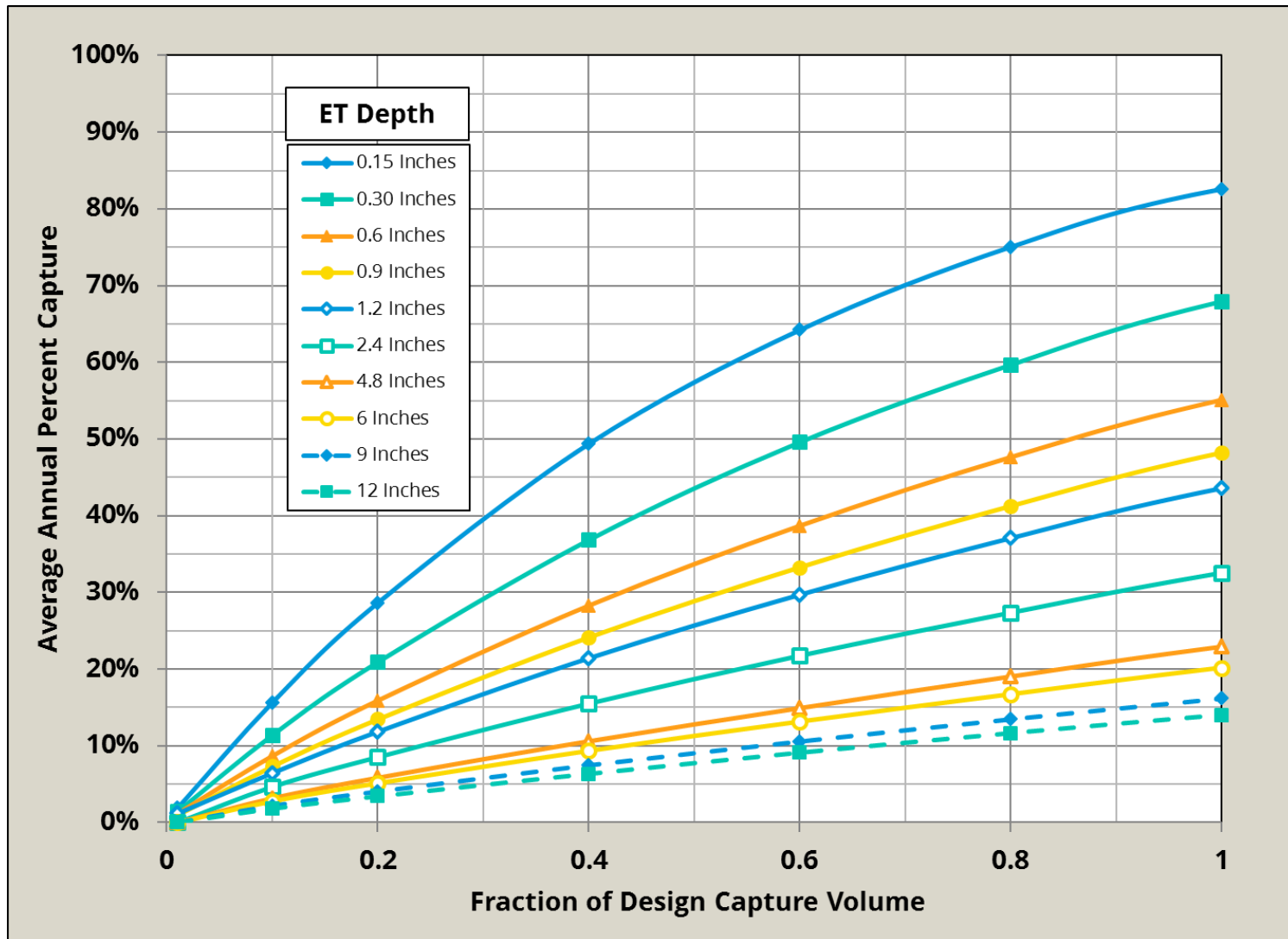

Figure B.5-5. Evapotranspiration Nomographs

Appendix B: Storm Water Pollutant Control Hydrologic Calculations and Sizing Methods

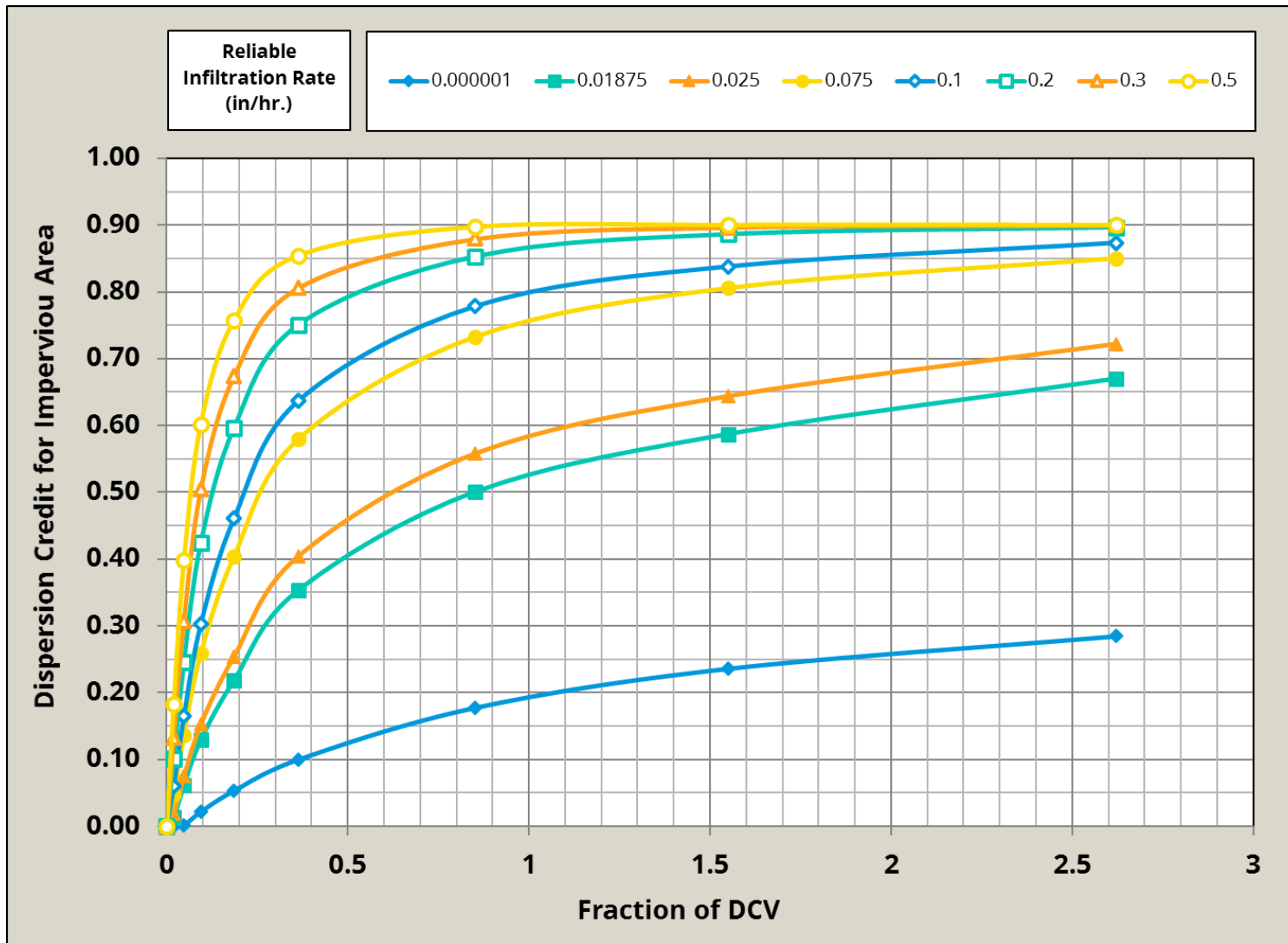

Figure B.5-6. 3” Amendment Dispersion Nomographs

Appendix B: Storm Water Pollutant Control Hydrologic Calculations and Sizing Methods

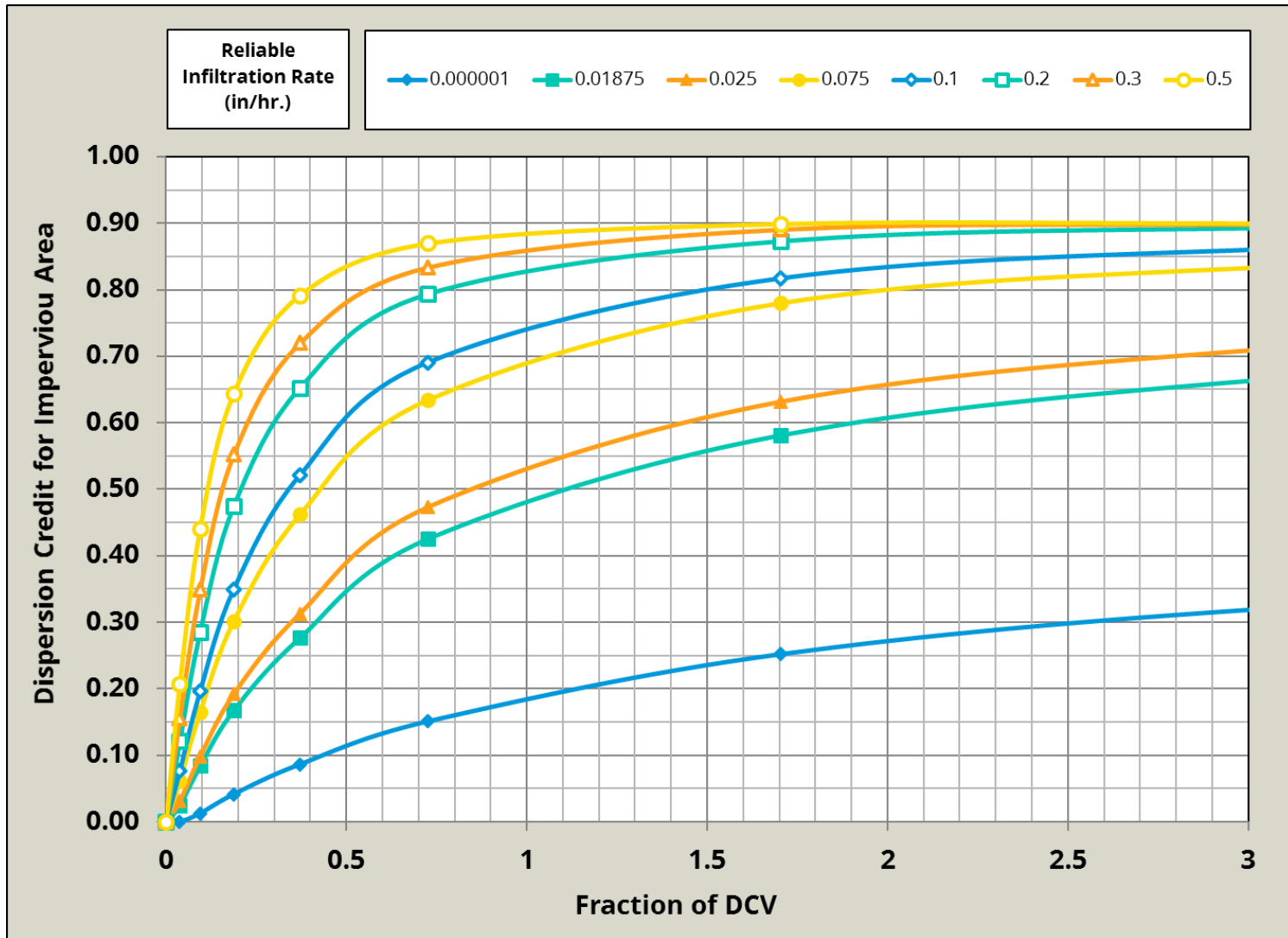

Figure B.5-7. 6” Amendment Dispersion Nomographs

Appendix B: Storm Water Pollutant Control Hydrologic Calculations and Sizing Methods

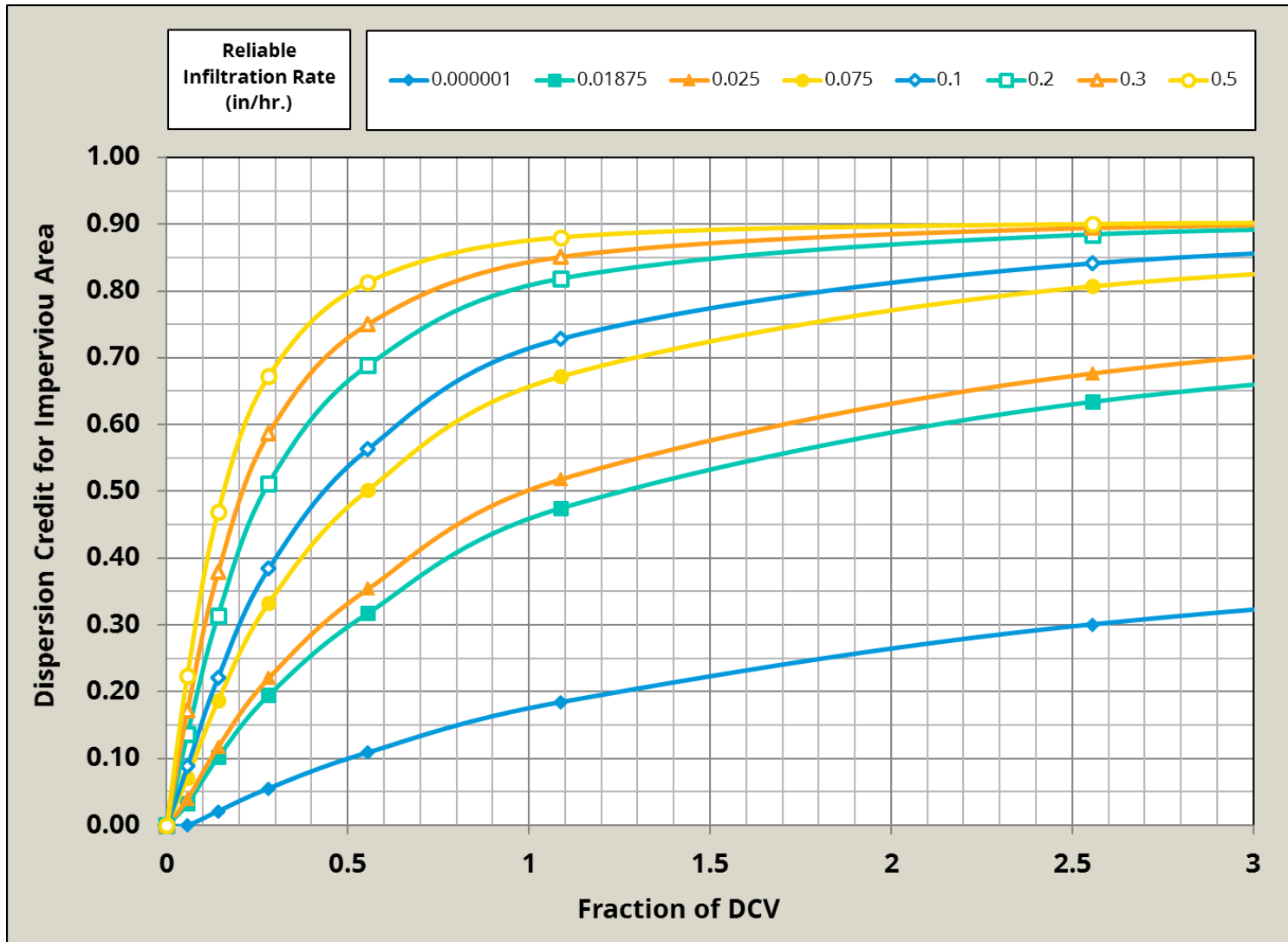

Figure B.5-8. 9<sup>th</sup> Amendment Dispersion Nomographs

Appendix B: Storm Water Pollutant Control Hydrologic Calculations and Sizing Methods

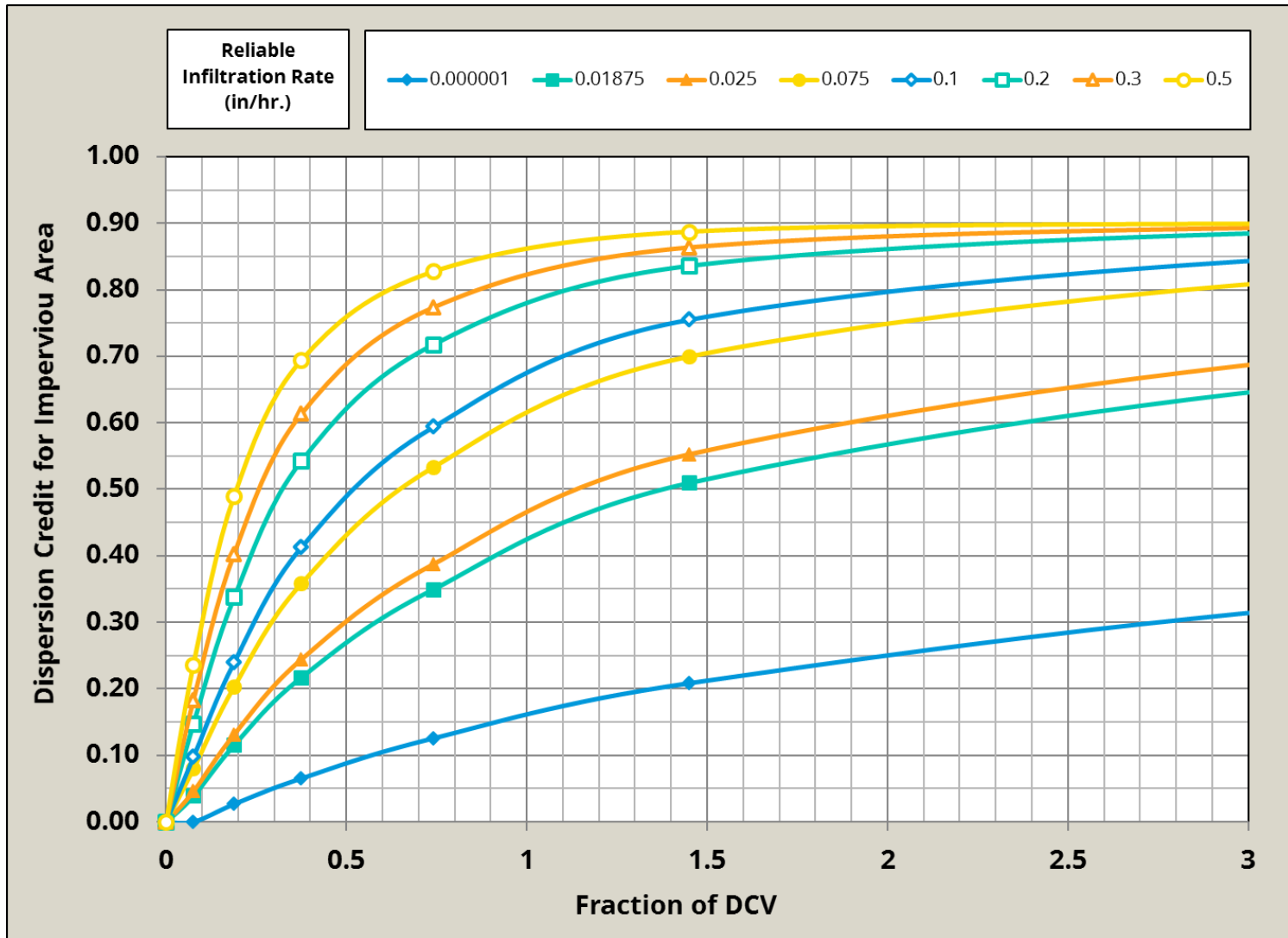

Figure B.5-9. 12" Amendment Dispersion Nomographs

Appendix B: Storm Water Pollutant Control Hydrologic Calculations and Sizing Methods

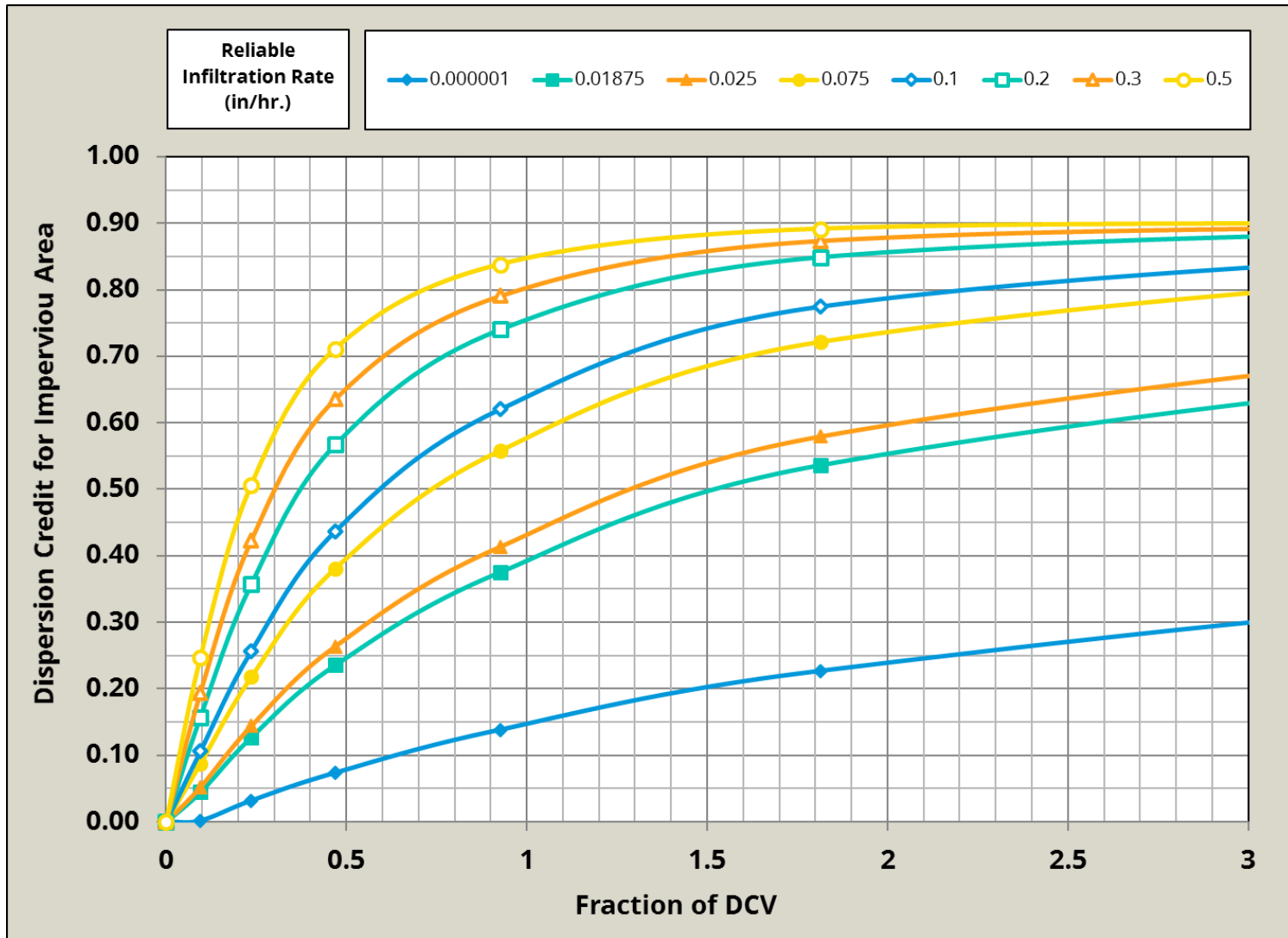

Figure B.5-10. 15" Amendment Dispersion Nomographs

Appendix B: Storm Water Pollutant Control Hydrologic Calculations and Sizing Methods

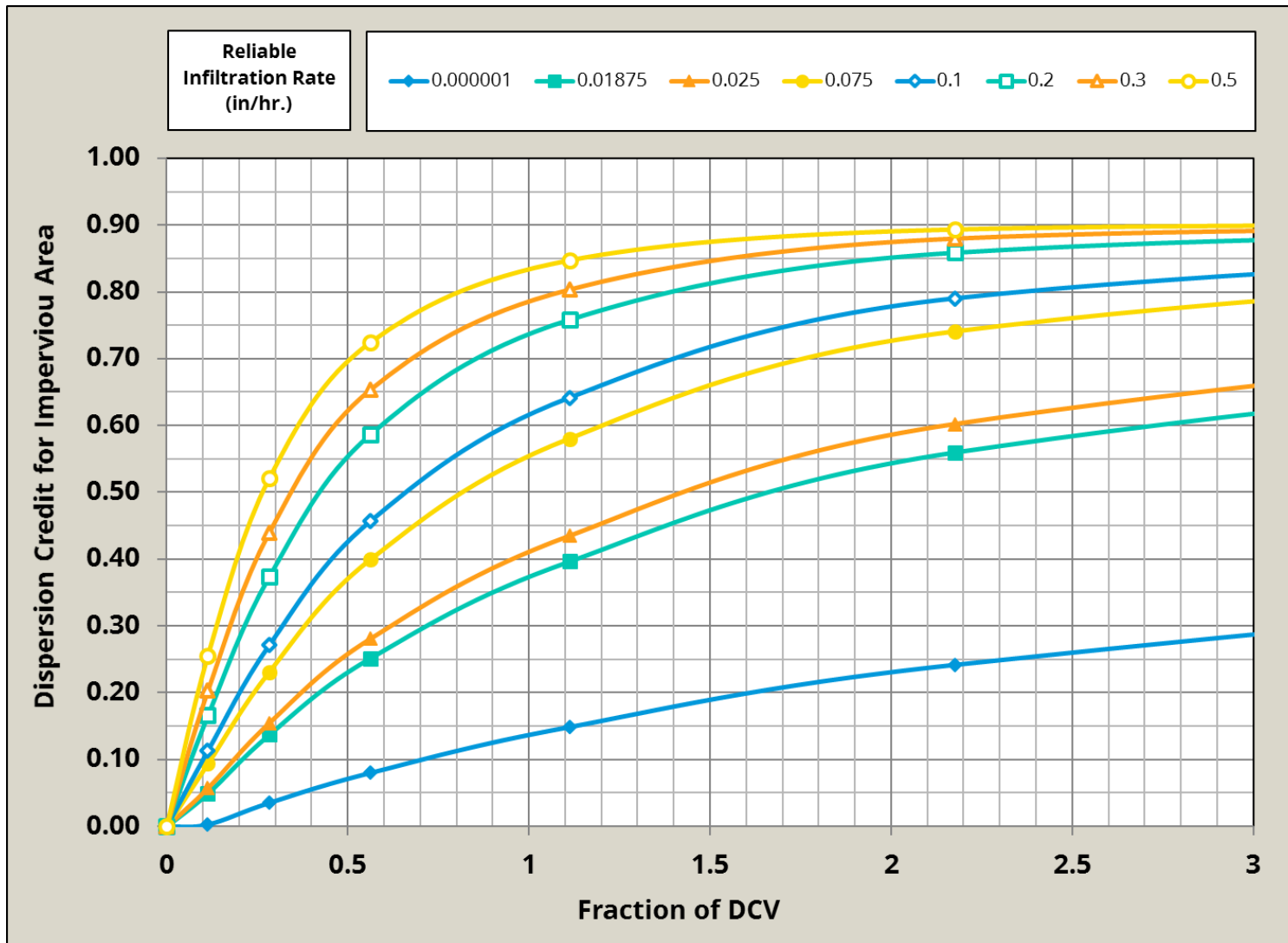

Figure B.5-11. 18” Amendment Dispersion Nomographs



## Appendix B: Storm Water Pollutant Control Hydrologic Calculations and Sizing Methods

This page was intentionally left blank.

### B.6 Flow-Thru Treatment Control BMPs (for use with Alternative Compliance)

The following methodology shall be used for selecting and sizing onsite flow-thru treatment control BMPs. These BMPs are to be used only when the project is participating in an alternative compliance program. This methodology consists of three steps:

- 1) Determine the PDP most significant pollutants of concern (Appendix B.6.1).
- 2) Select a flow-thru treatment control BMP that treats the PDP most significant pollutants of concern and meets the pollutant control BMP treatment performance standard (Appendix B.6.2).
- 3) Size the selected flow-thru treatment control BMP (Appendix B.6.3).

#### B.6.1 PDP Most Significant Pollutants of Concern

The following steps shall be followed to identify the PDP most significant pollutants of concern:

- 1) Compile the following information for the PDP and receiving water:
  - a. Receiving water quality (including pollutants for which receiving waters are listed as impaired under the Clean Water Act section 303(d) List; refer to Section 1.9);
  - b. Pollutants, stressors, and/or receiving water conditions that cause or contribute to the highest priority water quality conditions identified in the WQIP (refer to Section 1.9);
  - c. Land use type(s) proposed by the PDP and the storm water pollutants associated with the PDP land use(s) (see Table B.6–1).
- 2) From the list of pollutants identified in Step 1 identify the most significant PDP pollutants of concern. A PDP could have multiple most significant pollutants of concerns and shall include the highest priority water quality condition identified in the watershed WQIP and pollutants anticipated to be present onsite/generated from land use.

## Appendix B: Storm Water Pollutant Control Hydrologic Calculations and Sizing Methods

**Table B.6-1: Anticipated and Potential Pollutants Generated by Land Use Type**

Priority Project Categories	General Pollutant Categories								
	Sediment	Nutrients	Heavy Metals	Organic Compounds	Trash & Debris	Oxygen Demanding Substances	Oil & Grease	Bacteria & Viruses	Pesticides
Detached Residential Development	X	X			X	X	X	X	X
Attached Residential Development	X	X			X	P(1)	P(2)	P	X
Commercial Development >one acre	P(1)	P(1)	X	P(2)	X	P(5)	X	P(3)	P(5)
Heavy Industry	X		X	X	X	X	X		
Automotive Repair Shops			X	X(4)(5)	X		X		
Restaurants					X	X	X	X	P(1)
Hillside Development >5,000 ft <sup>2</sup>	X	X			X	X	X		X
Parking Lots	P(1)	P(1)	X		X	P(1)	X		P(1)
Retail Gasoline Outlets			X	X	X	X	X		
Streets, Highways & Freeways	X	P(1)	X	X(4)	X	P(5)	X	X	P(1)
X = anticipated P = potential (1) A potential pollutant if landscaping exists onsite. (2) A potential pollutant if the project includes uncovered parking areas. (3) A potential pollutant if land use involves food or animal waste products. (4) Including petroleum hydrocarbons. (5) Including solvents.									

## Appendix B: Storm Water Pollutant Control Hydrologic Calculations and Sizing Methods

### B.6.2 Selection of Flow-Thru Treatment Control BMPs

The following steps shall be followed to select the appropriate flow-thru treatment control BMPs for the PDP:

- 1) For each PDP most significant pollutant of concern identify the grouping using Table B.6-2. Table B.6-2 is adopted from the Model SUSMP.
- 2) Select the flow-thru treatment control BMP based on the grouping of pollutants of concern that are identified to be most significant in Step 1. This section establishes the pollutant control BMP treatment performance standard to be met for each grouping of pollutants in order to meet the standards required by the MS4 permit and how an applicant can select a non-proprietary or a proprietary BMP that meets the established performance standard. The grouping of pollutants of concern are:
  - a. Coarse Sediment and Trash (Appendix B.6.2.1)
  - b. Pollutants that tend to associate with fine particles during treatment (Appendix B.6.2.2)
  - c. Pollutants that tend to be dissolved following treatment (Appendix B.6.2.3)

**Table B.6-2: Grouping of Potential Pollutants of Concern**

Pollutant	Coarse Sediment and Trash	Suspended Sediment and Particulate-bound Pollutants <sup>1</sup>	Soluble-form Dominated Pollutants <sup>2</sup>
Sediment	X	X	
Nutrients			X
Heavy Metals		X	
Organic Compounds		X	
Trash & Debris	X		
Oxygen Demanding		X	
Bacteria		X	
Oil & Grease		X	
Pesticides		X	

<sup>1</sup> Pollutants in this category can be addressed to Medium or High effectiveness by effectively removing suspended sediments and associated particulate-bound pollutants. Some soluble forms of these pollutants will exist, however treatment mechanisms to address soluble pollutants are not necessary to remove these pollutants to a Medium or High effectiveness.

<sup>2</sup> Pollutants in this category are not typically addressed to a Medium or High level of effectiveness with particle and particulate-bound pollutant removal alone.

One flow-thru BMP can be used to satisfy the required pollutant control BMP treatment performance

## Appendix B: Storm Water Pollutant Control Hydrologic Calculations and Sizing Methods

standard for the PDP most significant pollutants of concern. In some situations it might be necessary to implement multiple flow-thru BMPs to satisfy the pollutant control BMP treatment performance standards. For example, a PDP has trash, nutrients and bacteria as the most significant pollutants of concern. If a vegetated filter strip is selected as a flow-thru BMP then it is anticipated to meet the performance standard in Appendix B.6.2.2 and B.6.2.3 but would need a trash removal BMP to meet the pollutant control BMP treatment performance standard in Appendix B.6.2.1 upstream of the vegetated filter strip. This could be achieved by fitting the inlets and/or outlets with racks or screens on to address trash.

### B.6.2.1 Coarse Sediment and Trash

If coarse sediment and/or trash and debris are identified as a pollutant of concern for the PDP, then BMPs must be selected to capture and remove these pollutants from runoff. The BMPs described below can be effective in removing coarse sediment and/or trash. These devices must be sized to treat the flow rate estimated using Worksheet B.6-1. Applicant can only select BMPs that have High or Medium effectiveness.

**Trash Racks and Screens [Coarse Sediment: Low effectiveness; Trash: Medium to High effectiveness]** are simple devices that can prevent large debris and trash from entering storm drain infrastructure and/or ensure that trash and debris are retained with downstream BMPs. Trash racks and screens can be installed at inlets to the storm drain system, at the inflow line to a BMP, and/or on the outflow structure from the BMP. Trash racks and screens are commercially available in many sizes and configurations or can be designed and fabricated to meet specific project needs.

**Hydrodynamic Separation Devices [Coarse Sediment: Medium to High effectiveness; Trash: Medium to High effectiveness]** are devices that remove coarse sediment, trash, and other debris from incoming flows through a combination of screening, settlement, and centrifugal forces. The design of hydrodynamic devices varies widely, more specific information can be found by contacting individual vendors. A list of hydrodynamic separator products approved by the Washington State Technology Acceptance Protocol-Ecology protocol can be found at:

<http://www.ecy.wa.gov/programs/wq/stormwater/newtech/technologies.html>.

Systems should be rated for “pretreatment” with a General Use Level Designation or provide results of field-scale testing indicating an equivalent level of performance.

**Catch Basin Insert Baskets [Coarse Sediment: Low effectiveness; Trash: Medium effectiveness, if appropriately maintained]** are manufactured filters, fabrics, or screens that are placed in inlets to remove trash and debris. The shape and configuration of catch basin inserts varies based on inlet type and configuration. Inserts are prone to clogging and bypass if large trash items are accumulated, and therefore require frequent observation and maintenance to remain effective.

## Appendix B: Storm Water Pollutant Control Hydrologic Calculations and Sizing Methods

Systems with screen size small enough to retain coarse sediment will tend to clog rapidly and should be avoided.

**Other Manufactured Particle Filtration Devices [Coarse Sediment: Medium to High effectiveness; Trash: Medium to High effectiveness]** include a range of products such as cartridge filters, bag filters, and other configurations that address medium to coarse particles. Systems should be rated for “pretreatment” with a General Use Level Designation under the Technology Acceptance Protocol-Ecology program or provide results of field-scale testing indicating an equivalent level of performance.

Note, any BMP that achieves Medium or High performance for suspended solids (See Section B.6.2.2) is also considered to address coarse sediments. However, some BMPs that address suspended solids do not retain trash (for example, swales and detention basins). These types of BMPs could be fitted with racks or screens on inlets or outlets to address trash.

### **BMP Selection for Pretreatment:**

Devices that address both coarse sediment and trash can be used as pretreatment devices for other BMPs, such as infiltration BMPs. However, it is recommended that BMPs that meet the performance standard in Appendix B.6.2.2 be used. A device with a “pretreatment” rating and General Use Level Designation under Technology Acceptance Protocol-Ecology is required for pretreatment upstream of infiltration basins and underground galleries. Pretreatment may also be provided as presettling basins or forebays as part of a pollutant control BMP instead of implementing a specific pretreatment device for systems where maintenance access to the facility surface is possible (to address clogging), expected sediment load is not high, and appropriate factors of safety are included in design.

**B.6.2.2 Suspended Sediment and Particulate-Bound Pollutants**

**Performance Standard**

The pollutant treatment performance standard is shown in Table B.6-3. This performance standard is consistent with the Washington State Technology Acceptance Protocol-Ecology Basic Treatment Level, and is also met by technologies receiving Phosphorus Treatment or Enhanced Treatment certification. This standard is based on pollutant removal performance for total suspended solids. Systems that provide effective TSS treatment also typically address trash, debris, and particulate bound pollutants and can serve as pre-treatment for offsite mitigation projects or for onsite infiltration BMPs.

**Table B.6-3: Performance Standard for Flow-Thru Treatment Control**

Influent Range	Criteria
20 – 100 mg/L TSS	Effluent goal $\leq$ 20 mg/L TSS
100 – 200 mg/L TSS	$\geq$ 80% TSS removal
>200 mg/L TSS	> 80% TSS removal

**Selecting Non-Proprietary BMPs**

Table B.6-4 identifies the categories of non-proprietary BMPs that are considered to meet the pollutant treatment performance standard if designed to contemporary design standards<sup>8</sup>. BMP types with an “High” ranking should be considered before those with an “Medium” ranking. Statistical analysis by category from the International Stormwater BMP Database (also presented in Table B.6-4) indicates each of these BMP types (as a categorical group) meets or nearly meets the performance standard. The International Stormwater BMP Database includes historic as well as contemporary BMP studies; contemporary BMP designs in these categories are anticipated to meet or exceed this standard on average.

---

<sup>8</sup> Contemporary design standards refers to design standards that are reasonably consistent with the current state of practice and are based on desired outcomes that are reasonably consistent with the context of the MS4 Permit and this manual. For example, a detention basin that is designed solely to mitigate peak flow rates would not be considered a contemporary water quality BMP design because it is not consistent with the goal of water quality improvement. Current state of the practice recognizes that a drawdown time of 24 to 72 hours is typically needed to promote settling. For practical purposes, design standards can be considered “contemporary” if they have been published within the last 10 years, preferably in California or Washington State, and are specifically intended for storm water quality management.

## Appendix B: Storm Water Pollutant Control Hydrologic Calculations and Sizing Methods

Table B.6-4: Flow-Thru Treatment Control BMPs Meeting Performance Standard

List of Acceptable Flow-Thru Treatment Control BMPs	Statistical Analysis of International Stormwater BMP Database				Evaluation of Conformance to Performance Standard		
	Count In/Out	TSS Mean Influent, mg/L	TSS Mean Effluent <sup>1</sup> , mg/L	Average Category Volume Reduct.	Volume-Adjusted Effluent Conc <sup>2</sup> , mg/L	Volume-Adjusted Removal Efficiency <sup>2</sup>	Level of Attainment of Performance Standard (with rationale)
Vegetated Filter Strip	361/282	69	31	38%	19	72%	Medium, effluent < 20 mg/L after volume adjustment
Vegetated Swale	399/346	45	33	48%	17	61%	Medium, effluent < 20 mg/L after volume adjustment
Detention Basin	321/346	125	42	33%	28	77%	Medium, percent removal near 80% after volume adjustment
Sand Filter/Media Bed Filter	381/358	95	19	NA <sup>3</sup>	19	80%	High, effluent and % removal meet criteria without adjustment
Lined Porous Pavement <sup>4</sup>	356/220	229	46	NA <sup>3,4</sup>	46	80%	High, % removal meets criteria without adjustment
Wet Pond	923/933	119	31	NA <sup>3</sup>	31	74%	Medium, percent removal near 80%

Source: 2014 BMP Performance Summaries and Statistical Appendices; 2010 Volume Performance Summary; available at: [www.bmpdatabase.org](http://www.bmpdatabase.org)

1 - A statistically significant difference between influent and effluent was detected at a p value of 0.05 for all categories.

2 - Estimates were adjusted to account for category-average volume reduction.

3 - Not Applicable as these BMPs are not designed for volume reduction and are anticipated to have very small incidental volume reduction.

4 - The category presented in this table represents a lined system for flow-thru treatment purposes. Porous pavement for retention purposes is an infiltration BMP, not a flow-thru BMP. This table should not be consulted for porous pavement for infiltration.

### Selecting Proprietary BMPs

Proprietary BMPs can be used if the BMP meets each of the following conditions:

- (1) **The proposed BMP meets the performance standard in Appendix B.6.2.2 as certified through third-party, field scale evaluation.** An active General Use Level Designation for Basic Treatment, Phosphorus Treatment or Enhanced Treatment under the Washington State Technology Acceptance Protocol-Ecology program is the preferred method of demonstrating that the performance standard is met. The list of certified technologies is updated as new technologies are approved (link below). Technologies with Pilot Use Level Designation and



## Appendix B: Storm Water Pollutant Control Hydrologic Calculations and Sizing Methods

Conditional Use Level Designations are not acceptable. Refer to: <http://www.ecy.wa.gov/programs/wq/stormwater/newtech/technologies.html>.

Alternatively, other field scale verification of 80 percent TSS capture, such as through Technology Acceptance Reciprocity Partnership or New Jersey Corporation for Advance Testing may be acceptable. A list of field-scale verified technologies under Technology Acceptance Reciprocity Partnership Tier II and New Jersey Corporation for Advance Testing can be accessed at: <http://www.njcat.org/verification-process/technology-verification-database.html> (refer to field verified technologies only).

- (2) **The proposed BMP is designed and maintained in a manner consistent with its performance certifications (see explanation below).** The applicant must demonstrate conclusively that the proposed application of the BMP is consistent with the basis of its certification/verification. Certifications or verifications issued by the Washington Technology Acceptance Protocol-Ecology program and the Technology Acceptance Reciprocity Partnership or New Jersey Corporation for Advance Testing programs are typically accompanied by a set of guidelines regarding appropriate design and maintenance conditions that would be consistent with the certification/verification. It is common for these approvals to specify the specific model of BMP, design capacity for given unit sizes, type of media that is the basis for approval, and/or other parameters.
- (3) **The proposed BMP is acceptable at the discretion of the City Engineer.** The applicant may be required to provide additional studies and/or required to meet additional design criteria beyond the scope of this document in order to demonstrate that these criteria are met. In determining the acceptability of a proprietary flow-thru treatment control BMP, the City Engineer should consider, as applicable, (a) the data submitted; (b) representativeness of the data submitted; (c) consistency of the BMP performance claims with pollutant control objectives; certainty of the BMP performance claims; (d) for projects within the public right of way and/or public projects: maintenance requirements, cost of maintenance activities, relevant previous local experience with operation and maintenance of the BMP type, ability to continue to operate the system in event that the vending company is no longer operating as a business; and (e) other relevant factors. If a proposed BMP is not accepted by the City Engineer, a written explanation/reason will be provided to the applicant

## Appendix B: Storm Water Pollutant Control Hydrologic Calculations and Sizing Methods

### B.6.2.3 Soluble-form dominated Pollutants (Nutrients)

If nutrients are identified as a most significant pollutant of concern for the PDP, then BMPs must be selected to meet the performance standard described in Appendix B.6.2.2 **and** must be selected to provide medium or high level of effectiveness for nutrient treatment as described in this section. The most common nutrient of concern in the San Diego region is nitrogen, therefore total nitrogen (TN) was used as the primary indicator of nutrient performance in storm water BMPs.

Selection of BMPs to address nutrients consists of two steps:

- 1) Determine if nutrients can be addressed via source control BMPs as described in Appendix E and Chapter 4. After applying source controls, if there are no remaining source areas for soluble nutrients, then this pollutant can be removed from the list of pollutants of concerns for the purpose of selecting flow-thru treatment control BMPs. Particulate nutrients will be addressed by the performance standard in Appendix B.6.2.2.
- 2) If soluble nutrients cannot be fully addressed with source controls, then select a flow-thru treatment control BMPs that meets the performance criteria in Table B.6-5 or select from the nutrient-specific menu of treatment control BMPs in Table B.6-6.
  - a. The performance standard for nitrogen removal (Table B.6-5) has been developed based on evaluation of the relative performance of available categories of non-proprietary BMPs.
  - b. For proprietary BMPs, submit third party performance data indicating that the criteria in Table B.6-5 are met. The applicant may be required to provide additional studies and/or required to meet additional design criteria beyond the scope of this document in order to demonstrate that these criteria are met. In determining the acceptability of a proprietary flow-thru treatment control BMP, the City Engineer should consider, as applicable, (a) the data submitted; (b) representativeness of the data submitted; (c) consistency of the BMP performance claims with pollutant control objectives; certainty of the BMP performance claims; (d) for projects within the public right of way and/or public projects: maintenance requirements, cost of maintenance activities, relevant previous local experience with operation and maintenance of the BMP type, ability to continue to operate the system in event that the vending company is no longer operating as a business; and (e) other relevant factors. If a proposed BMP is not accepted by the City Engineer, a written explanation/reason will be provided to the applicant.

## Appendix B: Storm Water Pollutant Control Hydrologic Calculations and Sizing Methods

**Table B.6-5: Performance Standard for Flow-Thru Treatment Control BMPs for Nutrient Treatment**

Basis	Criteria
<b>Treatment Basis</b>	Comparison of mean influent and effluent indicates significant concentration reduction of TN approximately 40 percent or higher based on studies with representative influent concentrations
<b>Combined Treatment and Volume Reduction Basis</b>	Combination of concentration reduction and volume reduction yields TN mass removal of approximately 40 percent or higher based on studies with representative influent concentrations

**Table B.6-6: Flow-Thru Treatment Control BMPs Meeting Nutrient Treatment Performance Standard**

List of Acceptable Flow-Thru Treatment Control BMPs for Nutrients	Statistical Analysis of International Stormwater BMP Database				Evaluation of Conformance to Performance Standard		
	Count In/Out	TN Mean Influent, mg/L	TN Mean Effluent <sup>1</sup> , mg/L	Average Category Volume Reduct.	Volume-Adjusted Effluent Conc <sup>2</sup> , mg/L	Volume-Adjusted Removal Efficiency <sup>2</sup>	Level of Attainment of Performance Standard (with rationale)
Vegetated Filter Strip	138/ 122	1.53	1.37	38%	0.85	44%	Medium, if designed to include volume reduction processes
Detention Basin	90/ 89	2.34	2.01	33%	1.35	42%	Medium, if designed to include volume reduction processes
Wet Pond	397/ 425	2.12	1.33	NA	1.33	37%	Medium, best concentration reduction among BMP categories, but limited volume reduction

Source: 2014 BMP Performance Summaries and Statistical Appendices; 2010 Volume Performance Summary; available at: [www.bmpdatabase.org](http://www.bmpdatabase.org)

1 - A statistically significant difference between influent and effluent was detected at a p value of 0.05 for all categories included.

2 - Estimates were adjusted to account for category-average volume reduction.

## Appendix B: Storm Water Pollutant Control Hydrologic Calculations and Sizing Methods

### B.6.3 Sizing Flow-Thru Treatment Control BMPs:

Flow-thru treatment control BMPs shall be sized to filter or treat the maximum flow rate of runoff produced from a rainfall intensity of 0.2 inch of rainfall per hour, for each hour of every storm event. The required flow-thru treatment rate should be adjusted for the portion of the DCV already retained or biofiltered onsite as described in Worksheet B.6-1. The following hydrologic method shall be used to calculate the flow rate to be filtered or treated:

$$Q = C \times i \times A$$

Where:

Q = Design flow rate in cubic feet per second

C = Runoff factor, area-weighted estimate using Table B.1-1.

i = Rainfall intensity of 0.2 in/hr.

A = Tributary area (acres) which includes the total area draining to the BMP, including any offsite or onsite areas that comingle with project runoff and drain to the BMP. Refer to Section 3.3.3 for additional guidance. Street projects consult Section 1.4.3.

**Worksheet B.6-1: Flow-Thru Design Flows**

Flow-thru Design Flows		Worksheet B.6-1		
1	DCV	DCV		cubic-feet
2	DCV retained	DCV <sub>retained</sub>		cubic-feet
3	DCV biofiltered	DCV <sub>biofiltered</sub>		cubic-feet
4	DCV requiring flow-thru (Line 1 – Line 2 – 0.67*Line 3)	DCV <sub>flow-thru</sub>		cubic-feet
5	Adjustment factor (Line 4 / Line 1)*	AF=		unitless
6	Design rainfall intensity	i=	0.20	in/hr
7	Area tributary to BMP (s)	A=		acres
8	Area-weighted runoff factor (estimate using Appendix B.2)	C=		unitless
9	Calculate Flow Rate = AF x (C x i x A)	Q=		cfs
10	<b><i>For Proprietary Biofiltration Only: <math>Q_{Bio}=1.5 \times Q</math></i></b>	$Q_{Bio}$ =		<i>cfs</i>

- 1) Adjustment factor shall be estimated considering only retention and biofiltration BMPs located upstream of flow-thru BMPs. That is, if the flow-thru BMP is upstream of the project's retention and biofiltration BMPs then the flow-thru BMP shall be sized using an adjustment factor of 1.
- 2) Volume based (e.g., dry extended detention basin) flow-thru treatment control BMPs shall be sized to the volume in Line 4 and flow based (e.g., vegetated swales) shall be sized to flow rate in Line 9. Sand filter and media filter can be designed either by volume in Line 4 or flow rate in Line 9.
- 3) Proprietary BMPs, if used, shall provide certified treatment capacity equal to or greater than the calculated flow rate in Line 9; certified treatment capacity per unit shall be consistent with third party certifications.

Appendix

C

ESCONDIDO STORM WATER DESIGN MANUAL

# Geotechnical and Groundwater Investigation Requirements

# Appendix C Geotechnical and Groundwater Investigation Requirements

**Feasibility of storm water infiltration is dependent on the geotechnical and groundwater conditions at the project site. The feasibility analysis must be conducted at a DMA level.**

This appendix is subdivided into the following:

- Appendix C.1 Simple Feasibility Criteria: This appendix is applicable when standard setbacks are used to make a determination that the DMA is in a no infiltration condition.
- Appendix C.2 Detailed Feasibility Criteria: This appendix can be used for feasibility determination for all DMAs.
- Appendix C.3 Geotechnical and Groundwater Investigation Report Requirements: This is applicable to all projects.

The permits required for land development and construction within the City are issued by the Community Development and Engineering Services Departments. These permits fall into two general categories: development permits and construction permits. Development permits or entitlements are discretionary in nature, granted at the discretion of a decision maker. Depending on the type of project, the decision maker could be City staff, a Hearing Officer, the Planning Commission, or the City Council. Examples of development permits include Coastal Development Permits, Site Development Permits, Neighborhood Development Permits, Conditional Use Permits, lot splits, condominium conversions, and Tentative Maps. Construction permits are ministerial, which means that projects found to comply with City standards and existing property entitlements can be permitted without a public hearing. Grading plans, improvement plans, and building plans are examples of ministerial permits.

### C.1 Simple Feasibility Criteria

When one of the following standard setbacks cannot be avoided, the applicant can classify the DMA as no infiltration condition provided an infiltration feasibility condition letter that meets the requirements in Appendix C.1.1. is included in the SWQMP submittal.

- Full and partial infiltration BMPs shall not be placed within existing fill materials greater than 5 feet thick; or
- Full and partial infiltration BMPs shall not be proposed within 10 feet (horizontal radial distance) of existing underground utilities, structures, or retaining walls; or
- Full and partial infiltration BMPs shall not be proposed within 50 feet of a natural slope (>25%) or within a distance of 1.5H from fill slopes where H is the height of the fill slope; or
- Full and partial infiltration BMPs shall not be proposed within 100 feet of contaminated soil or groundwater sites; or
- Other physical impairments (i.e., fire road egress, public safety considerations, etc.)

The setbacks must be the closest horizontal radial distance between the surface edge (at the overflow elevation) of the BMP to existing underground utilities, structures, retaining walls; or natural slopes; or fill slopes; or contaminated soil or groundwater site. The schematic for the setbacks is shown below.

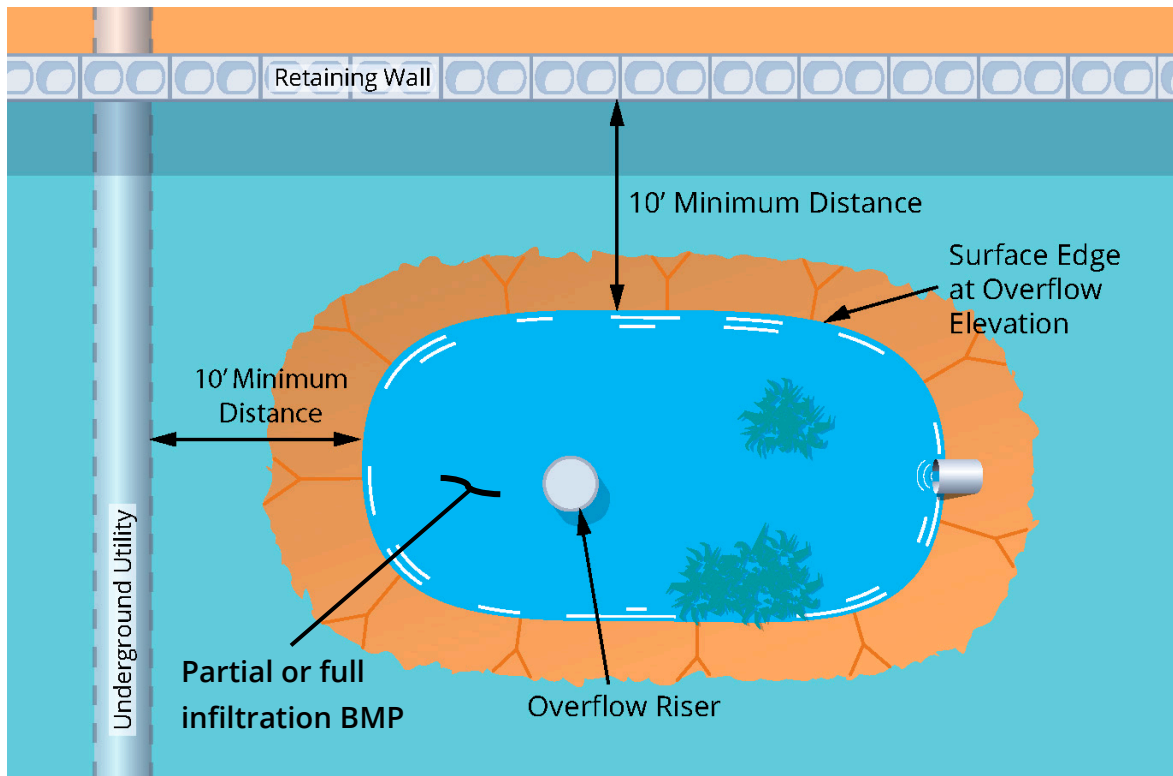

## Appendix C: Geotechnical and Groundwater Investigation Requirements

### C.1.1 Infiltration Feasibility Condition Letter

The geotechnical engineer shall provide an **Infiltration Feasibility Condition Letter** in the SWQMP to demonstrate that the DMA is in a no infiltration condition. The letter shall be stamped/signed by a licensed geotechnical engineer who prepared the letter.

The letter shall be submitted during the discretionary phase for private projects and during the initial project submittal to the Public Works Department for public projects. The letter shall at a minimum document:

- The phase of the project in which the geotechnical engineer first analyzed the site for infiltration feasibility.
- Results of previous geotechnical analyses conducted in the project area, if any.
- The development status of the site prior to the project application (i.e., new development with raw ungraded land, or redevelopment with existing graded conditions).
- The history of design discussions for the project footprint, resulting in the final design determination.
- Full/partial infiltration BMP standard setbacks to underground utilities, structures, retaining walls, fill slopes, and natural slopes applicable to the DMA that prevent full/partial infiltration.
- The physical impairments (i.e., fire road egress, public safety considerations, etc.) that prevent full/partial infiltration.
- The consideration of site design alternatives to achieve partial/full infiltration within the DMA.
- The extent site design BMPs requirements were included in the overall design.
- Conclusion or recommendation from the geotechnical engineer regarding the DMA's infiltration condition.
- An Exhibit for all applicable DMAs that clearly labels:
  - Proposed development areas and development type.
  - All applicable features and setbacks that prevent partial or full infiltration, including underground utilities, structures, retaining walls, fill slopes, natural slopes, and existing fill materials greater than 5 feet.
  - Potential locations for structural BMPs.
  - Areas where full/partial infiltration BMPs cannot be proposed.

Completion of Worksheet C.4-1(Form I-8A) and/or Worksheet C.4-2 (Form I-8B) is not required in instances where the applicant submits an infiltration feasibility condition letter that meets the requirements in this section.



## Appendix C: Geotechnical and Groundwater Investigation Requirements

### C.2 Detailed Feasibility Criteria

This appendix provides guidelines for performing and reporting feasibility analysis for infiltration with respect to geotechnical and groundwater conditions. It provides a framework for feasibility analysis at two phases of project development:

- **Planning Phase:** Simpler methods of conducting preliminary screening for feasibility; and
- **Design Phase:** When preliminary screening indicates infiltration is feasible, more rigorous analysis is needed to confirm feasibility and to develop design considerations and mitigation measures, if required.

**Planning Phase** At this project stage, information about the site may be limited, the proposed design features may be conceptual, and there may be an opportunity to adjust project plans to incorporate infiltration into the project layout during development. During this phase, project geotechnical consultants are typically responsible for exploring geologic conditions, performing preliminary analyses, and identifying particular design aspects that require more detailed investigation at later phases. As part of this process, the role of a planning-level infiltration feasibility assessment is to reach tentative conclusions regarding where infiltration is likely feasible, possibly feasible if done carefully, or clearly infeasible. This determination can help guide the design process by influencing project layout, selection of infiltration BMPs, and identifying if more detailed studies are necessary. The purpose of the planning phase is to identify potential geotechnical and groundwater impacts resulting from infiltration and to determine which impacts may be considered fatal flaws and which impacts may be possible to mitigate with design features. Determination of acceptable risks and/or mitigation measures may involve discussions with adjacent land owners and/or utility operators, as well as coordination with other projects under planning or design in the project vicinity. Early involvement of potentially impacted parties is critical to avoid potential late-stage design changes and schedule delays and to reduce potential future liabilities.

**Design Phase** During this phase, potential geotechnical and groundwater impacts must be evaluated and mitigation measures should be incorporated in the BMP design, as appropriate. Mitigation measures refer to design features or assumptions intended to reduce risks associated with storm water infiltration. While rules of thumb may be useful, if applied carefully, for the planning phase, the analyses conducted in the design phase require the involvement of a geotechnical professional familiar with the local conditions. One of the first steps in the design phase should be to determine if additional field and/or laboratory investigations are required (e.g., borings, test pits, laboratory or field testing) to further assess the geotechnical impacts of storm water infiltration. As the design of infiltration systems are highly dependent on the subsurface conditions, coordination with the storm water design team may be beneficial to limit duplicative efforts and costs.

**Worksheet C.4-1 (Form I-8A) and Worksheet C.4-2 (Form I-8B) are provided to document infiltration feasibility screening.** Worksheet C.4.1 (Form I-8A) includes information to be evaluated by geotechnical professionals and Worksheet C.4-2 (Form I-8B) includes information to be evaluated by environmental professionals, hydrogeologists and civil engineers. These worksheets are divided

## Appendix C: Geotechnical and Groundwater Investigation Requirements

into two parts:

Part 1 “Full Infiltration Feasibility Screening Criteria” is used to determine if the full design volume can be potentially infiltrated onsite.

Part 2 “Partial Infiltration versus No Infiltration Feasibility Screening Criteria” is used to determine if any amount of volume can be infiltrated. This is only used when the result of Part 1 is negative.

**Note that it is not required to investigate each and every criterion in the worksheet, a single “no” answer in Part 1 and Part 2 controls the feasibility.** If all the answers in Part 1 are “yes” then completion of Part 2 is not required. Note that a planning phase categorization, is typically based on initial site assessment results; therefore, it is not necessarily conclusive. Categorizations should be confirmed or revised, as necessary, based on more detailed design-level investigation and analysis during BMP design.

The applicant has discretion to implement full infiltration BMPs even in scenarios where the reliable infiltration rate is less than or equal to 0.5 inches per hour if there are no geotechnical or groundwater hazards associated with implementation of full infiltration BMPs.

### C.2.1 Geotechnical Feasibility Criteria

This section is divided into seven factors that shall be considered by the project geotechnical professional, as applicable, while assessing the feasibility of infiltration related to geotechnical conditions. **Note that during the planning phase, if one or more of these factors precludes infiltration as an approach, it is not required to assess the remaining factors.** However, if proposing infiltration BMPs, then each applicable factor in this section must be addressed.

The requirements in this section (Appendix C.2.1) are not applicable for DMAs that are identified as no infiltration condition based on one of the setbacks listed under Appendix C.1 and submission of the Infiltration Condition Letter with the SWQMP that meets the requirements in Appendix C.1.1.

#### C.2.1.1 Soil and Geologic Conditions

Site soils and geologic conditions influence the rate at which water can physically enter the soils. Site assessment approaches for soil and geologic conditions may consist of:

- Review of soil survey maps;
- Review of available reports on local geology to identify relevant features, such as depth to bedrock, rock type, lithology, faults, presence of fill materials and hydrostratigraphic or confining units;
- Review of previous geotechnical investigations in the area; and

## Appendix C: Geotechnical and Groundwater Investigation Requirements

- Site-specific geotechnical and/or geologic investigations (e.g., borings, infiltration tests, etc.).

Geotechnical investigations shall also seek to provide an assessment of whether soil infiltration properties are likely to be uniform or variable across the project site. Appendix D provides guidance on determining infiltration rates for planning and design phases.

### C.2.1.2 Settlement and Volume Change

Settlement and volume change limits the amount of infiltration that can be allowed without resulting in adverse impacts that cannot be mitigated. Upon considering the impacts of an infiltration design, the designer must identify areas where soil settlement or heave is likely and whether these conditions would be unfavorable to existing or proposed features. Settlement refers to the condition when soils decrease in volume, and heave refers to expansion of soils or increase in volume.

Volume changes in the soil can be induced by infiltration. The designer(s) must be aware of and consider these mechanisms while completing the feasibility screening including:

- Hydroconsolidation;
- Hydrocollapse;
- Expansive soils; and
- Liquefaction.

### C.2.1.3 Slope Stability

Infiltration of storm water has the potential to result in increased risk of slope failure of nearby slopes. This shall be assessed as part of both the project planning and design phases. Many factors impact the stability of slopes, including, but not limited to, slope inclination, soil strength, unit weight, geologic structure, and seepage forces. Increases in moisture content or rising ground water in the vicinity of a slope, which may result from storm water infiltration, have the potential to change the soil strength, unit weight and to add or cause seepage forces to the slope, which may destabilize the slope. When evaluating the effect of infiltration on the slope stability, the designer must consider all types of potential slope failures.

Slopes steeper than 4:1 (horizontal to vertical) are generally not suitable for infiltration systems unless demonstrated otherwise in a geotechnical investigation report. Slope setbacks for infiltration BMPs shall be determined on an individual project basis by a qualified professional and the approval of the setbacks is at the discretion of the City Engineer. Worksheet C.4-1 (Form I-8A) provides standard setbacks that may be used to establish infeasibility for infiltration BMPs without performing additional analysis. As a guideline, infiltration zones shall be set back at least 50 feet or 1.5 times the height of the slope unless evaluated by the geotechnical engineer.

## Appendix C: Geotechnical and Groundwater Investigation Requirements

### C.2.1.4 Utility Considerations

Utilities are either public or private infrastructure components that include underground pipelines and vaults (e.g., potable water, sewer, storm water, and gas pipelines), underground wires/conduit (e.g., telephone, cable, electrical) and above ground wiring and associated structures (e.g., electrical distribution and transmission lines). Utility considerations are typically within the purview of a geotechnical site assessment and shall be considered in assessing the feasibility of storm water infiltration. Infiltration has the potential to damage subsurface utilities and/or underground utilities may pose geotechnical hazards when infiltrated water is introduced. Impacts related to storm water infiltration in the vicinity of underground utilities are not likely to cause a fatal flaw in the design, but the designer must be aware of the potential cost impacts to the design during the planning phase.

Utility setbacks for infiltration BMPs shall be determined on an individual project basis by a qualified professional; the approval of the setbacks is at the discretion of the City Engineer. Worksheet C.4-1 (Form I-8A) provides standard setbacks that may be used to establish infeasibility for infiltration BMPs without performing additional analysis.

Check with utility owners for specific guidance.

### C.2.1.5 Groundwater Monitoring

Storm water infiltration and recharge to the underlying groundwater table may create a groundwater mound beneath the infiltration facility. The height and shape of the mound depends on the infiltration system design, the recharge rate, and the hydrogeologic conditions at the site, especially the horizontal hydraulic conductivity and the saturated thickness. Elevated groundwater levels can lead to several problems, including flooding and damage to structures and utilities through buoyancy and moisture intrusion, increase in inflow and infiltration into municipal sanitary sewer systems, and flow of water through existing utility trenches, including sewers, potentially leading to formation of sinkholes (Gobel et al., 2004). Mounding shall be considered by the geotechnical professional while performing the infiltration feasibility screening.

### C.2.1.6 Retaining Walls and Foundations

Development projects may include retaining walls or foundations in close proximity to proposed infiltration BMPs. These structures are designed to withstand the forces of the retained earth and other surface loading conditions such as nearby structures. Foundations include shallow foundations (spread and strip footings, mats) and deep foundations (piles, piers). Retaining walls and foundations can be impacted by increased water infiltration and result of potential increases in lateral pressures and reductions in soil strength. The geotechnical professional shall consider these factors while performing the infiltration feasibility screening.

## Appendix C: Geotechnical and Groundwater Investigation Requirements

### C.2.1.7 Other Factors

While completing the feasibility screening, other factors determined by the geotechnical professional to influence the feasibility of infiltration related to geotechnical conditions shall also be considered.

### C.2.1.8 Geotechnical Mitigation Measures

The following are intended as examples (not exclusive) of reasonable and not reasonable mitigation measures. Other measures may need to be considered for specific projects.

Typically reasonable:

- Configure infiltration BMPs to infiltrate water into native soil to avoid fill or other geotechnical hazards.
- Configure site with consideration to infiltration feasibility to avoid geotechnical hazards.
- Over-excavate and backfill with permeable material below BMPs to avoid infiltration into less permeable fill. A reasonable excavation limit below the BMP is 5 feet.
- Implement selective grading practices to place permeable materials in areas of proposed BMPs.
- Inclusion of an impermeable barrier in BMP side walls (5 feet) to reduce potential for lateral water movement.
- Consider that partial infiltration BMPs have a supplemental discharge pathway (underdrains) to limit infiltration when soil infiltration capacity is exceeded.

Not typically reasonable:

- Major improvements to existing building foundations to increase structural stability, such as requiring deep foundations when such foundations would not otherwise be required.
- Inclusion of cutoff trenches and drainage features to control downslope or off-site effects of increased infiltration.
- Installing mechanical devices to pump storm water to another area on the property for the purposes of implementing pollutant control BMPs across DMAs.

## C.2.2 Groundwater Quality and Water Balance Feasibility Criteria

This section is divided into seven factors that shall be considered by qualified design professionals as applicable, while assessing the feasibility of infiltration related to groundwater quality and water balance. **Note that during the planning phase, if one or more of these factors precludes**

## Appendix C: Geotechnical and Groundwater Investigation Requirements

infiltration as an approach, it is not required to assess the remaining factors. However, if proposing infiltration BMPs, then each applicable factor in this section must be addressed.

The requirements in this section (Appendix C.2.2) are not applicable for DMAs that are identified as no infiltration condition based on one of the setbacks listed under Appendix C.1 and submission of the Infiltration Condition Letter with the SWQMP that meets the requirements in Appendix C.1.1.

### C.2.2.1 Soil and Groundwater Contamination

Infiltration shall be avoided in areas with:

- Physical and chemical characteristics (e.g., appropriate cation exchange capacity, organic content, clay content and infiltration rate) which are not adequate for proper infiltration durations and treatment of runoff for the protection of groundwater beneficial uses. If ALL of the following criteria are met, then full infiltration must be avoided:
  - Cation Exchange Capacity(CEC) < 5 millequivalents per 100 g, as measured by the sodium acetate method (US EPA Method 9081); and,
  - United States Department of Agriculture (USDA) texture class of loamy sand or sand as determined by laboratory analysis of soil texture; and,
  - Soil organic matter content < 1% by mass as determined by loss on ignition (ASTM D2974); and,
  - A seasonally high groundwater table within 10 feet of the bottom surface of the proposed full infiltration BMP.
- Groundwater contamination and/or soil pollution, if infiltration could contribute to the movement or dispersion of soil or groundwater contamination or adversely affect ongoing clean-up efforts, either onsite or down-gradient of the project.

If full infiltration is under consideration for one of the above conditions, a site-specific analysis shall be conducted to determine where infiltration-based BMPs can be used without adverse impacts.

### C.2.2.2 Separation to Seasonal High Groundwater

The depth to seasonally high groundwater tables (normal high depth during the wet season) beneath the base of any infiltration BMP must be greater than 10 feet for full infiltration BMPs to be allowed. The depth to groundwater requirement can be reduced from 10 feet at the discretion of the approval agency if the underlying groundwater basin does not support beneficial uses and the groundwater quality is maintained at the proposed depth. Depth to seasonally high groundwater levels can be estimated based on well level measurements or redoximorphic methods.

### C.2.2.3 Wellhead Protection

Wellheads natural and man-made are water resources that may potentially be adversely impacted by

## **Appendix C: Geotechnical and Groundwater Investigation Requirements**

storm water infiltration through the introduction of contaminants or alteration in water supply and levels. It is recommended that the locations of wells and springs be identified early in the planning phase and site design be developed to avoid infiltration in the vicinity of these resources. Infiltration BMPs must be located a minimum of 100 feet horizontally from any water supply well.

### **C.2.2.4 Contamination Risks from Land Use Activities**

Concentration of storm water pollutants in runoff is highly dependent on the land uses and activities present in the area tributary to an infiltration BMP. Likewise, the potential for groundwater contamination due to the infiltration BMP is a function of pollutant abundance, concentration of pollutants in soluble forms, and the mobility of the pollutant in the subsurface soils. Hence, full infiltration BMPs must not be used for areas of industrial or light industrial activity.

The project applicant has an option to classify other land uses and activities that pose high threat to water quality not suitable for infiltration BMPs if source control BMPs to prevent exposure of high threat activities could not be implemented, or runoff from such activities could not be first treated or filtered to remove pollutants prior to infiltration. Approval of infeasibility due to high threat to water quality is evaluated on a case by case basis and is at the discretion of the City Engineer.

### **C.2.2.5 Consultation with Applicable Groundwater Agencies**

Infiltration activities should be coordinated with the applicable groundwater management agency, such as groundwater providers and/or resource protection agencies, to ensure protection of groundwater quality. It is recommended that coordination be initiated early in the planning phase to determine whether specific site assessment activities apply or whether these agencies have data available that may support the planning and design phases.

### **C.2.2.6 Water Balance Impacts on Stream Flow**

Use of infiltration systems to reduce surface water discharge volumes may result in additional volume of deeper infiltration compared to natural conditions, which may result in impacts to receiving channels associated with change in dry weather flow regimes. A relatively simple survey of hydrogeologic data (piezometer measurements, boring logs, regional groundwater maps) and downstream receiving water characteristics is generally adequate to determine whether there is potential for impacts and whether a more rigorous assessment is needed.

Where water balance conditions appear to be sensitive to development impacts and there is an elevated risk of impacts, a computational analysis may be warranted to evaluate the feasibility of infiltration. Such an analysis should account for precipitation, runoff, irrigation inputs, soil moisture retention, evapotranspiration, baseflow, and change in groundwater recharge on a long-term basis. Because water balance calculations are sensitive to the timing of precipitation versus evapotranspiration, it is most appropriate to utilize a continuous model simulation rather than basing calculations on average annual

## Appendix C: Geotechnical and Groundwater Investigation Requirements

or monthly normal conditions.

The following simple screening criteria can be used to determine if a more in-depth analysis is required:

- Proposed infiltration BMP is located within 250 feet of an ephemeral or year round stream; and,
- The proposed BMPs will be full infiltration BMPs; and,
- The seasonal high groundwater depth below the bottom surface of the infiltration BMP is less than 20 feet.

If any of the above screening criteria are not met, then infiltration is feasible. If all of the above screening criteria are met, additional investigations shall be performance by a qualified design professional.

### C.2.2.7 Other Factors

While completing the feasibility screening, other factors determined by the qualified design professional to influence the feasibility and desirability of infiltration related to groundwater quality and water balance shall also be considered.

### C.2.2.8 Groundwater Quality and Water Balance Mitigation Measures

The following are intended as examples (not exclusive) of reasonable and not reasonable mitigation measures. Other measures may need to be considered for specific projects.

Typically reasonable:

- Consider site layout changes to avoid contaminated soils or soils that lack adequate treatment capacity.
- Design infiltration BMPs to include biofiltration media or an amended media layer if site soils are deemed to lack the treatment capacity to be protective of groundwater quality.

Not typically reasonable:

- Requiring cleanup of contaminated sites for the primary purpose of allowing storm water infiltration.
- Active storm water pretreatment methods.
- Inclusion of cutoff trenches and drainage features to prevent groundwater migration toward contaminated sites.



### C.3 Geotechnical and Groundwater Investigation Report Requirements

The geotechnical investigation report(s) addressing onsite storm water infiltration shall include the following elements, as applicable. These and other reports may need to be completed by multiple professional disciplines, depending on the issues that need be addressed for a given site. It may also be necessary to prepare separate report(s) at the planning phase and design phase of a project if the methods and timing of analyses differ.

#### C.3.1 Site Evaluation

Site evaluation shall identify the following:

- Areas of contaminated soil or contaminated groundwater within the site;
- “Brown fields” near the site;
- Mapped soil type(s);
- Historic high groundwater level;
- Slopes steeper than 25 percent; and
- Location of water supply wells, septic systems (and expansion area), or underground storage tanks, or permitted gray water systems within 100 feet of a proposed infiltration BMP.

#### C.3.2 Field Investigation

Where the site evaluation indicates potential feasibility for onsite storm water infiltration BMPs, the following field investigations will be necessary to demonstrate suitability and to provide design recommendations.

##### C.3.2.1 Subsurface Exploration

Characterization of potential infiltration rates is a critical step in the categorization of the infiltration feasibility condition. Typically, subsurface exploration, sampling, and testing are necessary for characterizing infiltration rates as well as evaluating potential geologic or geotechnical hazards and constraints associated with storm water infiltration.

For the design phase, a minimum of two (2) in situ percolation or infiltration tests shall be conducted

## Appendix C: Geotechnical and Groundwater Investigation Requirements

within 50-feet of each proposed full storm water infiltration BMP (also refer to Table D.3-2 as in some instances based on the test method selected more than 2 tests may be required). The tests shall be conducted at the same elevation as the base of the proposed full infiltration BMP and be representative of the conditions below the proposed full infiltration BMP.

An exploratory excavation shall be extended to a depth of at least 10-feet below the base of a proposed full infiltration BMP to demonstrate adequate separation from groundwater.

All exploratory excavations shall be logged in detail and the logs shall be included in the geotechnical investigation report. Low permeability or impermeable materials (i.e. clay horizons) shall be identified. Indicate any obvious evidence of soil contamination.

All exploratory excavations shall be properly filled at the completion of testing.

### C.3.2.2 Material Testing and Infiltration Testing

Various material testing and in situ infiltration testing methods and guidance for appropriate factor of safety for full infiltration BMPs are discussed in detail in Appendix D. Infiltration testing methods described in Appendix D include surface and shallow excavation and deeper subsurface tests.

### C.3.2.3 Evaluation of Depth to Groundwater

An evaluation of the depth to groundwater is required to confirm the feasibility of infiltration. Full infiltration BMPs may not be feasible in high groundwater conditions (within 10 feet of the base of infiltration BMP) unless an exemption is granted by the City Engineer. The 10 feet separation criterion is not applicable for partial infiltration condition BMPs.

### C.3.3 Reporting Requirements by the Project Geotechnical Engineer

The geotechnical investigation report shall address the following key elements, and where appropriate, mitigation recommendations shall be provided.

- Identify areas of the project site where infiltration is likely to be feasible and provide justifications for selection of those areas based on soil types, slopes, proximity to existing features, etc.
- Worksheet C.4-1 (Form I-8A) completed by the project geotechnical consultant.
  - **Note:** Form I-8A is not required for DMAs that are determined to be in a No Infiltration Condition based on Worksheet C.4-2 (Form I-8B) or by submitting a no infiltration condition letter that meets the requirements in Appendix C.1.1.
- Investigate, evaluate and estimate the vertical infiltration rates and capacities in accordance

## Appendix C: Geotechnical and Groundwater Investigation Requirements

with the guidance provided in Appendix D which describes infiltration testing and appropriate factors of safety to be applied to infiltration testing results. The site may be broken into sub-basins based on the opinion of the geotechnical consultant with different infiltration rates.

- Describe the infiltration test results and/or correlation with published infiltration rates based on soil parameters or classification. For planning phase feasibility screening and design of partial infiltration BMPs, a factor of safety of 2 must be used. When full infiltration BMPs are proposed, the geotechnical engineer must complete Section A (Suitability Assessment) in Worksheet D.5-1 (Form I-9) and include it in the geotechnical report.
- Investigate the subsurface geological conditions and geotechnical conditions that would affect infiltration or migration of storm water toward structures, slopes, utilities, or other features. Provide an opinion on the anticipated flow path of infiltrated water. Indicate if the water will flow into pavement sections, utility trench bedding, wall drains, foundation drains, other permeable improvements, or daylight.
- Investigate depth to groundwater. Include an estimate of the high seasonal groundwater elevations.
- Provide the reliable infiltration rates.
- Provide a concluding opinion regarding whether or not the proposed onsite storm water infiltration BMP will result in soil piping, daylight water seepage, slope instability, or ground settlement.
- Recommend reasonable measures to substantially mitigate or avoid potentially detrimental effects of the storm water infiltration BMPs or associated soil response on existing or proposed improvements or structures, utilities, slopes or other features within and adjacent to the site.
- Provide guidance for the selection and location of infiltration BMPs, including the minimum separations between such infiltration BMPs and structures, streets, utilities, manufactured and existing slopes, engineered fills, utilities, or other features. Include guidance for reasonable measures that could be used to reduce the minimum separations or to mitigate the potential impacts of infiltration BMPs.

### C.3.4 Reporting Requirements by the Project SWQMP Preparer

The project SWQMP preparer has the following responsibilities:

- Complete Worksheet C.4-2 (Form I-8B) and include it in the PDP SWQMP submittal.

## Appendix C: Geotechnical and Groundwater Investigation Requirements

- **Note:** Form I-8B is not required for DMAs that are determined to be in a No Infiltration Condition based on Worksheet C.4-1 (Form I-8A) or by submitting a no infiltration condition letter that meets the requirements in Appendix C.1.1.
- In the PDP SWQMP provide a concluding opinion whether or not proposed infiltration BMPs will affect seasonality of ephemeral streams.
- Evaluate proposed use of the site (industrial use, residential use, etc.), soil and groundwater data and provide a concluding opinion in the PDP SWQMP whether proposed storm water infiltration could cause adverse impacts to groundwater quality, and if it does cause impacts, whether the impacts could be reasonably mitigated.
- Worksheet C.4-3 and Worksheet D.5-1 (Form I-9) must be completed and included it in the PDP SWQMP submittal when full infiltration BMPs are proposed.

Appendix C: Geotechnical and Groundwater Investigation Requirements

GEOTECHNICAL SUBMITTAL FOR CATEGORIZATION OF INFILTRATION FEASIBILITY CONDITION  
(Worksheet C.4-1/FORM I-8A)

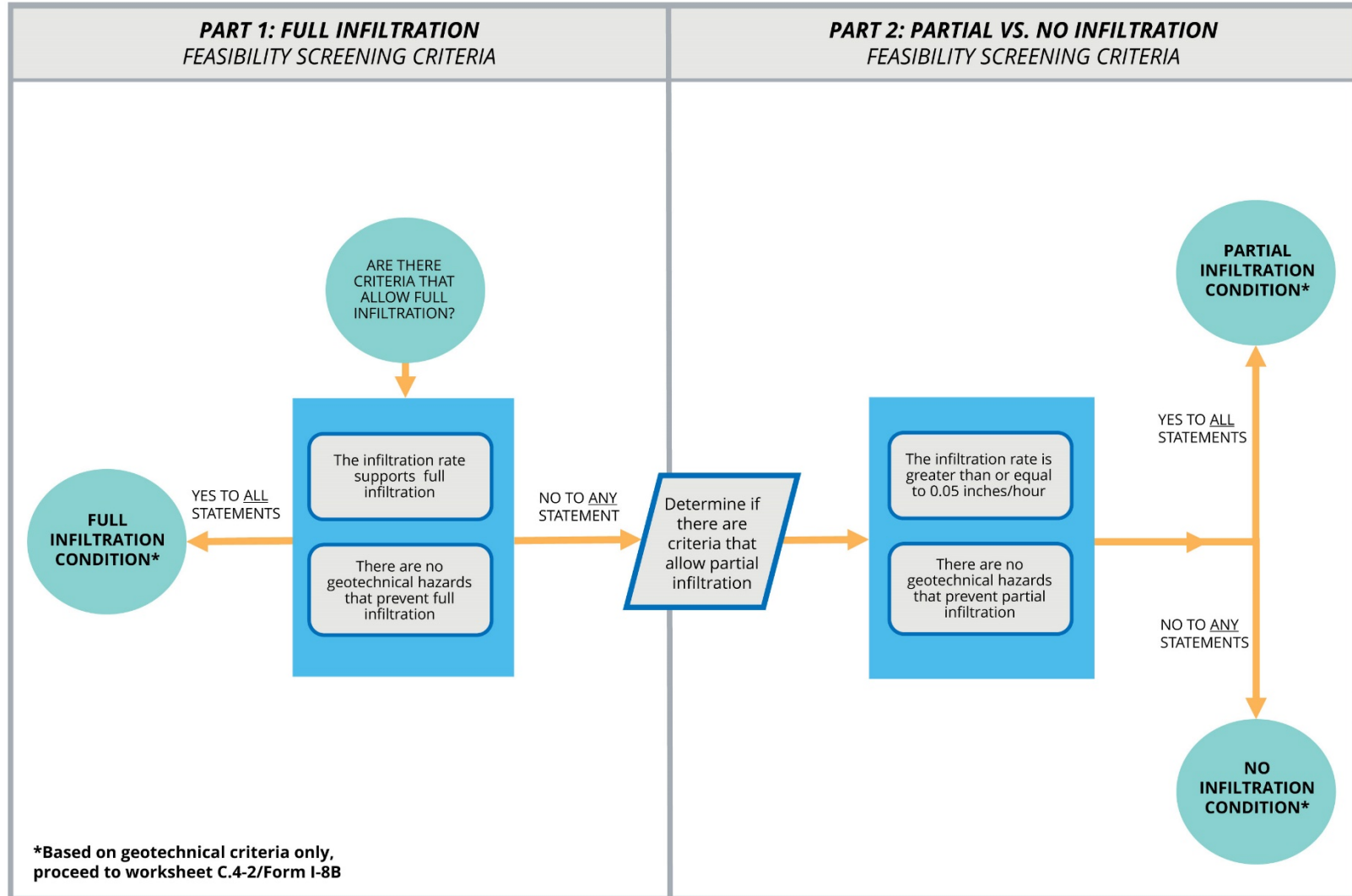

## Appendix C: Geotechnical and Groundwater Investigation Requirements

This page was intentionally left blank.

## Appendix C: Geotechnical and Groundwater Investigation Requirements

### Worksheet C.4-1: Categorization of Infiltration Feasibility Condition Based on Geotechnical Conditions<sup>9</sup>

Categorization of Infiltration Feasibility Condition based on Geotechnical Conditions		Worksheet C.4-1: Form I-8A <sup>10</sup>
<b>Part 1 - Full Infiltration Feasibility Screening Criteria</b>		
<b>DMA(s) Being Analyzed:</b>	<b>Project Phase:</b>	
<b>Criteria 1: Infiltration Rate Screening</b>		
1A	<p>Is the mapped hydrologic soil group according to the NRCS Web Soil Survey or UC Davis Soil Web Mapper Type A or B and corroborated by available site soil data<sup>11</sup>?</p> <p><input type="checkbox"/> Yes; the DMA may feasibly support full infiltration. Answer “Yes” to Criteria 1 Result or continue to Step 1B if the applicant elects to perform infiltration testing.</p> <p><input type="checkbox"/> No; the mapped soil types are A or B but is not corroborated by available site soil data (continue to Step 1B).</p> <p><input type="checkbox"/> No; the mapped soil types are C, D, or “urban/unclassified” and is corroborated by available site soil data. Answer “No” to Criteria 1 Result.</p> <p><input type="checkbox"/> No; the mapped soil types are C, D, or “urban/unclassified” but is not corroborated by available site soil data (continue to Step 1B).</p>	
1B	<p>Is the reliable infiltration rate calculated using planning phase methods from Table D.3-1?</p> <p><input type="checkbox"/> Yes; Continue to Step 1C.</p> <p><input type="checkbox"/> No; Skip to Step 1D.</p>	
1C	<p>Is the reliable infiltration rate calculated using planning phase methods from Table D.3-1 greater than 0.5 inches per hour?</p> <p><input type="checkbox"/> Yes; the DMA may feasibly support full infiltration. Answer “Yes” to Criteria 1 Result.</p> <p><input type="checkbox"/> No; full infiltration is not required. Answer “No” to Criteria 1 Result.</p>	

<sup>9</sup> Note that it is not required to investigate each and every criterion in the worksheet, a single “no” answer in Part 1, Part 2, Part 3, or Part 4 determines a full, partial, or no infiltration condition.

<sup>10</sup> This form must be completed each time there is a change to the site layout that would affect the infiltration feasibility condition. Previously completed forms shall be retained to document the evolution of the site storm water design.

<sup>11</sup> Available data includes site-specific sampling or observation of soil types or texture classes, such as obtained from borings or test pits necessary to support other design elements.

## Appendix C: Geotechnical and Groundwater Investigation Requirements

Categorization of Infiltration Feasibility Condition based on Geotechnical Conditions		Worksheet C.4-1: Form I-8A <sup>10</sup>
1D	<p><b>Infiltration Testing Method.</b> Is the selected infiltration testing method suitable during the design phase (see Appendix D.3)? Note: Alternative testing standards may be allowed with appropriate rationales and documentation.</p> <p><input type="checkbox"/> Yes; continue to Step 1E.</p> <p><input type="checkbox"/> No; select an appropriate infiltration testing method.</p>	
1E	<p><b>Number of Percolation/Infiltration Tests.</b> Does the infiltration testing method performed satisfy the minimum number of tests specified in Table D.3-2?</p> <p><input type="checkbox"/> Yes; continue to Step 1F.</p> <p><input type="checkbox"/> No; conduct appropriate number of tests.</p>	
1F	<p><b>Factor of Safety.</b> Is the suitable Factor of Safety selected for full infiltration design? See guidance in D.5; Tables D.5-1 and D.5-2; and Worksheet D.5-1 (Form I-9).</p> <p><input type="checkbox"/> Yes; continue to Step 1G.</p> <p><input type="checkbox"/> No; select appropriate factor of safety.</p>	
1G	<p><b>Full Infiltration Feasibility.</b> Is the average measured infiltration rate divided by the Factor of Safety greater than 0.5 inches per hour?</p> <p><input type="checkbox"/> Yes; answer “Yes” to Criteria 1 Result.</p> <p><input type="checkbox"/> No; answer “No” to Criteria 1 Result.</p>	
Criteria 1 Result	<p>Is the estimated reliable infiltration rate greater than 0.5 inches per hour within the DMA where runoff can reasonably be routed to a BMP?</p> <p><input type="checkbox"/> Yes; the DMA may feasibly support full infiltration. Continue to Criteria 2.</p> <p><input type="checkbox"/> No; full infiltration is not required. Skip to Part 1 Result.</p>	



## Appendix C: Geotechnical and Groundwater Investigation Requirements

Categorization of Infiltration Feasibility Condition based on Geotechnical Conditions		Worksheet C.4-1: Form I-8A <sup>10</sup>	
<p>Summarize infiltration testing methods, testing locations, replicates, and results and summarize estimates of reliable infiltration rates according to procedures outlined in D.5. Documentation should be included in project geotechnical report.</p>			
<b>Criteria 2: Geologic/Geotechnical Screening</b>			
2A	<p>If all questions in Step 2A are answered “Yes,” continue to Step 2B.</p> <p>For any “No” answer in Step 2A answer “No” to Criteria 2, and submit an “Infiltration Feasibility Condition Letter” that meets the requirements in Appendix C.1.1. The geologic/geotechnical analyses listed in Appendix C.2.1 do not apply to the DMA because one of the following setbacks cannot be avoided and therefore result in the DMA being in a no infiltration condition. The setbacks must be the closest horizontal radial distance from the surface edge (at the overflow elevation) of the BMP.</p>		
2A-1	Can the proposed full infiltration BMP(s) avoid areas with existing fill materials greater than 5 feet thick below the infiltrating surface?	<input type="checkbox"/> Yes	<input type="checkbox"/> No
2A-2	Can the proposed full infiltration BMP(s) avoid placement within 10 feet of existing underground utilities, structures, or retaining walls?	<input type="checkbox"/> Yes	<input type="checkbox"/> No
2A-3	Can the proposed full infiltration BMP(s) avoid placement within 50 feet of a natural slope (>25%) or within a distance of 1.5H from fill slopes where H is the height of the fill slope?	<input type="checkbox"/> Yes	<input type="checkbox"/> No

## Appendix C: Geotechnical and Groundwater Investigation Requirements

Categorization of Infiltration Feasibility Condition based on Geotechnical Conditions		Worksheet C.4-1: Form I-8A <sup>10</sup>	
2B	<p>When full infiltration is determined to be feasible, a geotechnical investigation report must be prepared that considers the relevant factors identified in Appendix C.2.1.</p> <p>If all questions in Step 2B are answered “Yes,” then answer “Yes” to Criteria 2 Result. If there are “No” answers continue to Step 2C.</p>		
2B-1	<p><b>Hydroconsolidation.</b> Analyze hydroconsolidation potential per approved ASTM standard due to a proposed full infiltration BMP.</p> <p>Can full infiltration BMPs be proposed within the DMA without increasing hydroconsolidation risks?</p>	<input type="checkbox"/> Yes	<input type="checkbox"/> No
2B-2	<p><b>Expansive Soils.</b> Identify expansive soils (soils with an expansion index greater than 20) and the extent of such soils due to proposed full infiltration BMPs.</p> <p>Can full infiltration BMPs be proposed within the DMA without increasing expansive soil risks?</p>	<input type="checkbox"/> Yes	<input type="checkbox"/> No
2B-3	<p><b>Liquefaction.</b> If applicable, identify mapped liquefaction areas. Evaluate liquefaction hazards in accordance with Section 6.4.2 of the City of San Diego's Guidelines for Geotechnical Reports (2011 or most recent edition). Liquefaction hazard assessment shall take into account any increase in groundwater elevation or groundwater mounding that could occur as a result of proposed infiltration or percolation facilities.</p> <p>Can full infiltration BMPs be proposed within the DMA without increasing liquefaction risks?</p>	<input type="checkbox"/> Yes	<input type="checkbox"/> No
2B-4	<p><b>Slope Stability.</b> If applicable, perform a slope stability analysis in accordance with the ASCE and Southern California Earthquake Center (2002) Recommended Procedures for Implementation of DMG Special Publication 117, Guidelines for Analyzing and Mitigating Landslide Hazards in California to determine minimum slope setbacks for full infiltration BMPs. See the City of San Diego's Guidelines for Geotechnical Reports (2011) to determine which type of slope stability analysis is required.</p> <p>Can full infiltration BMPs be proposed within the DMA without increasing slope stability risks?</p>	<input type="checkbox"/> Yes	<input type="checkbox"/> No
2B-5	<p><b>Other Geotechnical Hazards.</b> Identify site-specific geotechnical hazards not already mentioned (refer to Appendix C.2.1).</p> <p>Can full infiltration BMPs be proposed within the DMA without increasing risk of geologic or geotechnical hazards not already mentioned?</p>	<input type="checkbox"/> Yes	<input type="checkbox"/> No



## Appendix C: Geotechnical and Groundwater Investigation Requirements

Categorization of Infiltration Feasibility Condition based on Geotechnical Conditions		Worksheet C.4-1: Form I-8A <sup>10</sup>
<b>Part 1 Result – Full Infiltration Geotechnical Screening</b> <sup>12</sup>		<b>Result</b>
If answers to both Criteria 1 and Criteria 2 are “Yes”, a full infiltration design is potentially feasible based on Geotechnical conditions only.  If either answer to Criteria 1 or Criteria 2 is “No”, a full infiltration design is not required.		<input type="checkbox"/> Full infiltration Condition  <input type="checkbox"/> Complete Part 2
<b>Part 2 – Partial vs. No Infiltration Feasibility Screening Criteria</b>		
<b>DMA(s) Being Analyzed:</b>		<b>Project Phase:</b>
<b>Criteria 3 : Infiltration Rate Screening</b>		
3A	<p><b>NRCS Type C, D, or “urban/unclassified”:</b> Is the mapped hydrologic soil group according to the NRCS Web Soil Survey or UC Davis Soil Web Mapper is Type C, D, or “urban/unclassified” and corroborated by available site soil data?</p> <input type="checkbox"/> Yes; the site is mapped as C soils and a reliable infiltration rate of 0.15 in/hr. is used to size partial infiltration BMPS. Answer “Yes” to Criteria 3 Result.  <input type="checkbox"/> Yes; the site is mapped as D soils or “urban/unclassified” and a reliable infiltration rate of 0.05 in/hr. is used to size partial infiltration BMPS. Answer “Yes” to Criteria 3 Result.  <input type="checkbox"/> No; infiltration testing is conducted (refer to Table D.3-1), continue to Step 3B.	
3B	<p><b>Infiltration Testing Result:</b> Is the reliable infiltration rate (i.e. average measured infiltration rate/2) greater than 0.05 in/hr. and less than or equal to 0.5 in/hr?</p> <input type="checkbox"/> Yes; the site may support partial infiltration. Answer “Yes” to Criteria 3 Result. <input type="checkbox"/> No; the reliable infiltration rate (i.e. average measured rate/2) is less than 0.05 in/hr., partial infiltration is not required. Answer “No” to Criteria 3 Result.	

---

<sup>12</sup> To be completed using gathered site information and best professional judgement considering the definition of MEP in the MS4 Permit. Additional testing and/or studies may be required by City Engineer to substantiate findings.

## Appendix C: Geotechnical and Groundwater Investigation Requirements

Categorization of Infiltration Feasibility Condition based on Geotechnical Conditions		Worksheet C.4-1: Form I-8A <sup>10</sup>	
Criteria 3 Result	<p>Is the estimated reliable infiltration rate (i.e., average measured infiltration rate/2) greater than or equal to 0.05 inches/hour and less than or equal to 0.5 inches/hour at any location within each DMA where runoff can reasonably be routed to a BMP?</p> <p><input type="checkbox"/> Yes; Continue to Criteria 4.</p> <p><input type="checkbox"/> No; Skip to Part 2 Result.</p>		
<p>Summarize infiltration testing and/or mapping results (i.e. soil maps and series description used for infiltration rate).</p>			
<b>Criteria 4: Geologic/Geotechnical Screening</b>			
4A	<p>If all questions in Step 4A are answered “Yes,” continue to Step 2B.</p> <p>For any “No” answer in Step 4A answer “No” to Criteria 4 Result, and submit an “Infiltration Feasibility Condition Letter” that meets the requirements in Appendix C.1.1. The geologic/geotechnical analyses listed in Appendix C.2.1 do not apply to the DMA because one of the following setbacks cannot be avoided and therefore result in the DMA being in a no infiltration condition. The setbacks must be the closest horizontal radial distance from the surface edge (at the overflow elevation) of the BMP.</p>		
4A-1	Can the proposed partial infiltration BMP(s) avoid areas with existing fill materials greater than 5 feet thick?	<input type="checkbox"/> Yes	<input type="checkbox"/> No
4A-2	Can the proposed partial infiltration BMP(s) avoid placement within 10 feet of existing underground utilities, structures, or retaining walls?	<input type="checkbox"/> Yes	<input type="checkbox"/> No
4A-3	Can the proposed partial infiltration BMP(s) avoid placement within 50 feet of a natural slope (>25%) or within a distance of 1.5H from fill slopes where H is the height of the fill slope?	<input type="checkbox"/> Yes	<input type="checkbox"/> No
4B	<p>When full infiltration is determined to be feasible, a geotechnical investigation report must be prepared that considers the relevant factors identified in Appendix C.2.1</p> <p>If all questions in Step 4B are answered “Yes,” then answer “Yes” to Criteria 4 Result. If there are any “No” answers continue to Step 4C.</p>		

## Appendix C: Geotechnical and Groundwater Investigation Requirements

Categorization of Infiltration Feasibility Condition based on Geotechnical Conditions		Worksheet C.4-1: Form I-8A <sup>10</sup>	
4B-1	<p><b>Hydroconsolidation.</b> Analyze hydroconsolidation potential per approved ASTM standard due to a proposed full infiltration BMP.</p> <p>Can partial infiltration BMPs be proposed within the DMA without increasing hydroconsolidation risks?</p>	<input type="checkbox"/> Yes	<input type="checkbox"/> No
4B-2	<p><b>Expansive Soils.</b> Identify expansive soils (soils with an expansion index greater than 20) and the extent of such soils due to proposed full infiltration BMPs.</p> <p>Can partial infiltration BMPs be proposed within the DMA without increasing expansive soil risks?</p>	<input type="checkbox"/> Yes	<input type="checkbox"/> No
4B-3	<p><b>Liquefaction.</b> If applicable, identify mapped liquefaction areas. Evaluate liquefaction hazards in accordance with Section 6.4.2 of the City of San Diego's Guidelines for Geotechnical Reports (2011). Liquefaction hazard assessment shall take into account any increase in groundwater elevation or groundwater mounding that could occur as a result of proposed infiltration or percolation facilities.</p> <p>Can partial infiltration BMPs be proposed within the DMA without increasing liquefaction risks?</p>	<input type="checkbox"/> Yes	<input type="checkbox"/> No
4B-4	<p><b>Slope Stability.</b> If applicable, perform a slope stability analysis in accordance with the ASCE and Southern California Earthquake Center (2002) Recommended Procedures for Implementation of DMG Special Publication 117, Guidelines for Analyzing and Mitigating Landslide Hazards in California to determine minimum slope setbacks for full infiltration BMPs. See the City of San Diego's Guidelines for Geotechnical Reports (2011) to determine which type of slope stability analysis is required.</p> <p>Can partial infiltration BMPs be proposed within the DMA without increasing slope stability risks?</p>	<input type="checkbox"/> Yes	<input type="checkbox"/> No
4B-5	<p><b>Other Geotechnical Hazards.</b> Identify site-specific geotechnical hazards not already mentioned (refer to Appendix C.2.1).</p> <p>Can partial infiltration BMPs be proposed within the DMA without increasing risk of geologic or geotechnical hazards not already mentioned?</p>	<input type="checkbox"/> Yes	<input type="checkbox"/> No
4B-6	<p><b>Setbacks.</b> Establish setbacks from underground utilities, structures, and/or retaining walls. Reference applicable ASTM or other recognized standard in the geotechnical report.</p> <p>Can partial infiltration BMPs be proposed within the DMA using recommended setbacks from underground utilities, structures, and/or retaining walls?</p>	<input type="checkbox"/> Yes	<input type="checkbox"/> No

## Appendix C: Geotechnical and Groundwater Investigation Requirements

Categorization of Infiltration Feasibility Condition based on Geotechnical Conditions		Worksheet C.4-1: Form I-8A <sup>10</sup>	
4C	<p><b>Mitigation Measures.</b> Propose mitigation measures for each geologic/geotechnical hazard identified in Step 4B. Provide a discussion on geologic/geotechnical hazards that would prevent partial infiltration BMPs that cannot be reasonably mitigated in the geotechnical report. See Appendix C.2.1.8 for a list of typically reasonable and typically unreasonable mitigation measures.</p> <p>Can mitigation measures be proposed to allow for partial infiltration BMPs? If the question in Step 4C is answered “Yes,” then answer “Yes” to Criteria 4 Result.</p> <p>If the question in Step 4C is answered “No,” then answer “No” to Criteria 4 Result.</p>	<input type="checkbox"/> Yes	<input type="checkbox"/> No
Criteria 4 Result	<p>Can infiltration of greater than or equal to 0.05 inches/hour and less than or equal to 0.5 inches/hour be allowed without increasing the risk of geologic or geotechnical hazards that cannot be reasonably mitigated to an acceptable level?</p>	<input type="checkbox"/> Yes	<input type="checkbox"/> No
<p>Summarize findings and basis; provide references to related reports or exhibits.</p>			

## Appendix C: Geotechnical and Groundwater Investigation Requirements

Categorization of Infiltration Feasibility Condition based on Geotechnical Conditions	Worksheet C.4-1: Form I-8A <sup>10</sup>
<b>Part 2 – Partial Infiltration Geotechnical Screening Result<sup>13</sup></b>	<b>Result</b>
<p>If answers to both Criteria 3 and Criteria 4 are “Yes”, a partial infiltration design is potentially feasible based on geotechnical conditions only.</p> <p>If answers to either Criteria 3 or Criteria 4 is “No”, then infiltration of any volume is considered to be infeasible within the site.</p>	<p><input type="checkbox"/> Partial Infiltration Condition</p> <p><input type="checkbox"/> No Infiltration Condition</p>

---

<sup>13</sup> To be completed using gathered site information and best professional judgement considering the definition of MEP in the MS4 Permit. Additional testing and/or studies may be required by City Engineer to substantiate findings.



## Appendix C: Geotechnical and Groundwater Investigation Requirements

This page was intentionally left blank.

Appendix C: Geotechnical and Groundwater Investigation Requirements

SWQMP PREPARER SUBMITTAL FOR CATEGORIZATION OF INFILTRATION FEASIBILITY CONDITION  
(Worksheet C.4-2/FORM I-8B)

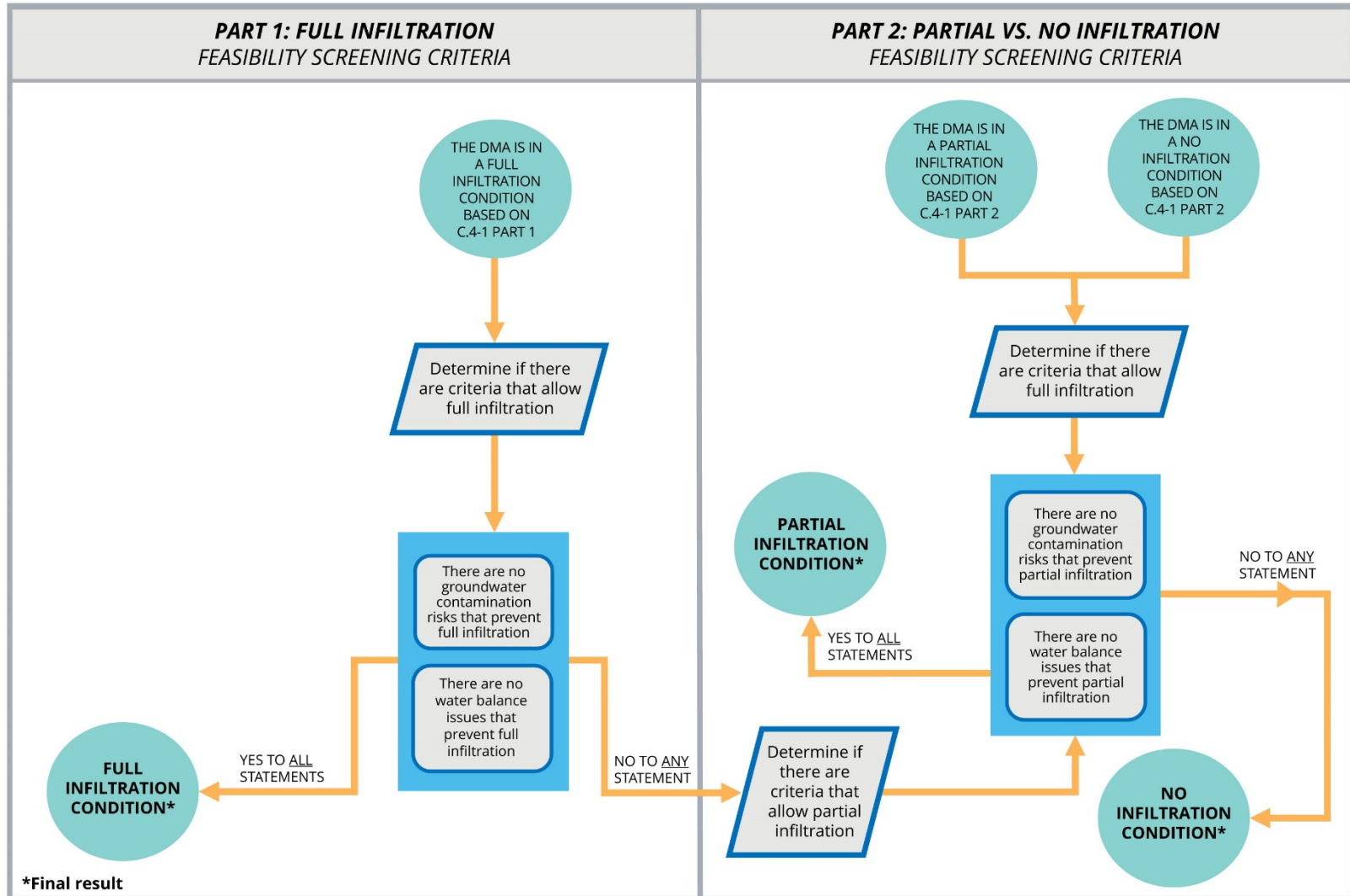

## Appendix C: Geotechnical and Groundwater Investigation Requirements

This page was intentionally left blank.

## Appendix C: Geotechnical and Groundwater Investigation Requirements

### Worksheet C.4-2: Categorization of Infiltration Feasibility Condition based on Groundwater and Water Balance Conditions<sup>14</sup>

Categorization of Infiltration Feasibility Condition based on Groundwater and Water Balance Conditions		Worksheet C.4-2: Form I-8B <sup>15</sup>
<b>Part 1 - Full Infiltration Feasibility Screening Criteria</b>		
<b>DMA(s) Being Analyzed:</b>	<b>Project Phase:</b>	
<b>Criteria 1: Groundwater Screening</b>		
1A	<p><b>Groundwater Depth.</b> Is the depth to seasonally high groundwater tables (normal high depth during the wet season) beneath the base of any full infiltration BMP greater than 10 feet?</p> <p><input type="checkbox"/> Yes; continue to Step 1B.</p> <p><input type="checkbox"/> No; The depth to groundwater is less than or equal to 10 feet, but site layout changes or reasonable mitigation measures can be proposed to support full infiltration BMPs. Continue to step 1B.</p> <p><input type="checkbox"/> No; The depth to groundwater is less than or equal to 10 feet and site layout changes or reasonable mitigation measures cannot be proposed to support full infiltration BMPs. Answer “No” for Criteria 1 Result.</p>	
1B	<p><b>Contaminated Soil/Groundwater.</b> Are proposed full infiltration BMPs at least 250 feet away from contaminated soil or groundwater sites? This can be confirmed using GeoTracker (<a href="http://geotracker.waterboards.ca.gov">geotracker.waterboards.ca.gov</a>) to identify open contaminated sites. The setbacks must be the closest horizontal radial distance from the surface edge (at the overflow elevation) of the BMP.</p> <p><input type="checkbox"/> Yes; continue to Step 1C.</p> <p><input type="checkbox"/> No; However, site layout changes or reasonable mitigation measures can be proposed to support full infiltration BMPs. Continue to Step 1C.</p> <p><input type="checkbox"/> No; Site layout changes or reasonable mitigation measures cannot be proposed to support full infiltration BMPs. Answer “No” to Criteria 1 Result.</p>	

<sup>14</sup> Note that it is not required to investigate each and every criterion in the worksheet, a single “no” answer in Part 1, Part 2, part 3, or Part 4 determines a full, partial, or no infiltration condition.

<sup>15</sup> This form must be completed each time there is a change to the site layout that would affect the infiltration feasibility condition. Previously completed forms shall be retained to document the evolution of the site storm water design.

## Appendix C: Geotechnical and Groundwater Investigation Requirements

Categorization of Infiltration Feasibility Condition based on Groundwater and Water Balance Conditions		Worksheet C.4-2: Form I-8B <sup>15</sup>
1C	<p><b>Inadequate Soil Treatment Capacity.</b> Are full infiltration BMPs proposed in DMA soils that have adequate soil treatment capacity?</p> <p>The DMA has adequate soil treatment capacity if <b>ALL</b> of the following criteria (detailed in C.2.2.1) for all soil layers beneath the infiltrating surface are met:</p> <ul style="list-style-type: none"> <li>• USDA texture class is sandy loam or loam or silt loam or silt or sandy clay loam or clay loam or silty clay loam or sandy clay or silty clay or clay; and</li> <li>• Cation Exchange Capacity (CEC) greater than 5 milliequivalents/100g; and</li> <li>• Soil organic matter is greater than 1%; and</li> <li>• Groundwater table is equal to or greater than 10 feet beneath the base of the full infiltration BMP.</li> </ul> <p><input type="checkbox"/> Yes; continue to Step 1D.</p> <p><input type="checkbox"/> No; However, site layout changes or reasonable mitigation measures can be proposed to support full infiltration BMPs. Continue to Step 1D.</p> <p><input type="checkbox"/> No; Site layout changes or reasonable mitigation measures cannot be proposed to support full infiltration BMPs. Answer “No” to Criteria 1 Result.</p>	
1D	<p><b>Other Groundwater Contamination Hazards.</b> Are there site-specific groundwater contamination hazards not already mentioned (refer to Appendix C.2.2) that can be reasonably mitigated to support full infiltration BMPs?</p> <p><input type="checkbox"/> Yes; there are other contamination hazards identified that can be mitigated. Answer “Yes” to Criteria 1 Result.</p> <p><input type="checkbox"/> No; there are other contamination hazards identified that cannot be mitigated. Answer “No” to Criteria 1 Result.</p> <p><input type="checkbox"/> N/A; no contamination hazards are identified. Answer “Yes” to Criteria 1 Result.</p>	
Criteria 1 Result	<p>Can infiltration greater than 0.5 inches per hour be allowed without increasing risk of groundwater contamination that cannot be reasonably mitigated to an acceptable level? See Appendix C.2.2.8 for a list of typically reasonable and typically unreasonable mitigation measures.</p> <p><input type="checkbox"/> Yes; Continue to Part 1, Criteria 2.</p> <p><input type="checkbox"/> No; Continue to Part 1 Result.</p>	

## Appendix C: Geotechnical and Groundwater Investigation Requirements

Summarize groundwater quality and any mitigation measures proposed. Documentation should focus on groundwater table, mapped soil types and contaminated site locations.

## Appendix C: Geotechnical and Groundwater Investigation Requirements

Categorization of Infiltration Feasibility Condition based on Groundwater and Water Balance Conditions	Worksheet C.4-2: Form I-8B <sup>15</sup>
<b>Criteria 2: Water Balance Screening</b>	
2A	<p><b>Ephemeral Stream Setback.</b> Does the proposed full infiltration BMP meet both the following?</p> <ul style="list-style-type: none"> <li>The full infiltration BMP is located at least 250 feet away from an ephemeral stream; <b>AND</b></li> <li>The bottom surface of the full infiltration BMP is at a depth 20 feet or greater from seasonally high groundwater tables.</li> </ul> <p><input type="checkbox"/> Yes; Answer “Yes” to Criteria 2 Result.</p> <p><input type="checkbox"/> No; Continue to Step 2B.</p>
2B	<p><b>Mitigation Measures.</b> Can site layout changes be proposed to support full infiltration BMPs?</p> <p><input type="checkbox"/> Yes; the site can be reconfigured to mitigate potential water balance issues. Answer “Yes” to Criteria 2 Result.</p> <p><input type="checkbox"/> No; the site cannot be reconfigured to mitigate potential water balance issues. Continue to Step 2C and provide discussion.</p>
2C	<p><b>Additional studies.</b> Do additional studies support full infiltration BMPs?</p> <p>In the event that water balance effects are used to reject full infiltration (anticipated to be rare), additional analysis shall be completed and documented by a qualified professional indicating the site-specific information evaluated and the technical basis for this finding.</p> <p><input type="checkbox"/> Yes; Answer “Yes” to Criteria 2 Result.</p> <p><input type="checkbox"/> No; Answer “No” to Criteria 2 Result.</p>
Criteria 2 Result	<p>Can infiltration greater than 0.5 inches per hour be allowed without causing potential water balance issues such as change of seasonality of ephemeral streams?</p> <p><input type="checkbox"/> Yes; Continue to Part 1 Result.</p> <p><input type="checkbox"/> No; Continue to Part 1 Result.</p>

## Appendix C: Geotechnical and Groundwater Investigation Requirements

Categorization of Infiltration Feasibility Condition based on Groundwater and Water Balance Conditions	Worksheet C.4-2: Form I-8B <sup>15</sup>
<p>Summarize potential water balance effects. Documentation should focus on mapping and soil data regarding proximity to ephemeral streams and groundwater depth.</p>	
Part 1 – Full Infiltration Groundwater and Water Balance Screening Result <sup>16</sup>	Result
<p>If answers to Criteria 1 and 2 are “Yes”, a full infiltration design is potentially feasible. The feasibility screening category is Full Infiltration based on groundwater conditions.</p> <p>If answer to Criteria 1 or Criteria 2 is “No”, infiltration may be possible to some extent but would not generally be feasible or desirable to achieve a “full infiltration” design based on groundwater conditions. Proceed to Part 2.</p>	<input type="checkbox"/> Full Infiltration <input type="checkbox"/> Complete Part 2

---

<sup>16</sup> To be completed using gathered site information and best professional judgement considering the definition of MEP in the MS4 Permit. Additional testing and/or studies may be required by City Engineer to substantiate findings.



## Appendix C: Geotechnical and Groundwater Investigation Requirements

Categorization of Infiltration Feasibility Condition based on Groundwater and Water Balance Conditions	Worksheet C.4-2: Form I-8B <sup>15</sup>
<b>Part 2 – Partial vs. No Infiltration Feasibility Screening Criteria</b>	
<b>DMA(s) Being Analyzed:</b>	<b>Project Phase:</b>
<b>Criteria 3: Groundwater Screening</b>	
<p><b>Contaminated Soil/Groundwater.</b> Are partial infiltration BMPs proposed at least 100 feet away from contaminated soil or groundwater sites? This can be confirmed using GeoTracker (<a href="http://geotracker.waterboards.ca.gov">geotracker.waterboards.ca.gov</a>) to identify open contaminated sites. This criterion is intentionally a smaller radius than full infiltration, as the potential quantity of infiltration from partial infiltration BMPs is smaller.</p> <p><input type="checkbox"/> Yes; Answer “Yes” to Criteria 3 Result.</p> <p><input type="checkbox"/> No; However, site layout changes can be proposed to avoid contaminated soils or soils that lack adequate treatment capacity. Select “Yes” to Criteria 3 Result. It is a requirement for the SWQMP preparer to identify potential mitigation measures.</p> <p><input type="checkbox"/> No; Contaminated soils or soils that lack adequate treatment capacity cannot be avoided and partial infiltration BMPs are not feasible. Select “No” to Criteria 3 Result.</p>	
<p>Criteria 3 Result: Can infiltration of greater than or equal to 0.05 inches/hour and less than or equal to 0.5 inches/hour be allowed without increasing risk of groundwater contamination that cannot be reasonably mitigated to an acceptable level?</p> <p>Yes; Continue to Part 2, Criteria 4.</p> <p><input type="checkbox"/> No; Skip to Part 2 Result.</p>	
<p>Summarize findings and basis. Documentation should focus on mapped soil types and contaminated site locations.</p>          	

## Appendix C: Geotechnical and Groundwater Investigation Requirements

Categorization of Infiltration Feasibility Condition based on Groundwater and Water Balance Conditions	Worksheet C.4-2: Form I-8B <sup>15</sup>
<b>Criteria 4: Water Balance Screening</b>	
<p><b>Additional studies.</b> In the event that water balance effects are used to reject partial infiltration (anticipated to be rare), a qualified professional must provide an analysis of the incremental effects of partial infiltration BMPs on the water balance compared to incidental infiltration under a no infiltration scenario (e.g. precipitation, irrigation, etc.).</p>	
<p>Criteria 4 Result: Can infiltration of greater than or equal to 0.05 inches/hour and less than or equal to 0.5 inches/hour be allowed without causing potential water balance issues such as change of seasonality of ephemeral streams?</p> <p><input type="checkbox"/> Yes: Continue to Part 2 Result.</p> <p><input type="checkbox"/> No: Continue to Part 2 Result.</p>	
<p>Summarize potential water balance effects. Documentation should focus on mapping and soil data regarding proximity to ephemeral streams and groundwater depth</p>	
Part 2 – Partial Infiltration Groundwater and Water Balance Screening Result <sup>17</sup>	Result
<p>If answers to Criteria 3 and Criteria 4 are “Yes”, a partial infiltration design is potentially feasible. The feasibility screening category is Partial Infiltration based on groundwater and water balance conditions.</p> <p>If answer to Criteria 3 or Criteria 4 is “No”, then infiltration of any volume is considered to be infeasible within the site. The feasibility screening category is No Infiltration based on groundwater or water balance condition.</p>	<p><input type="checkbox"/> Partial Infiltration Condition</p> <p><input type="checkbox"/> No Infiltration Condition</p>

---

<sup>17</sup> To be completed using gathered site information and best professional judgement considering the definition of MEP in the MS4 Permit. Additional testing and/or studies may be required by City Engineer to substantiate findings.

## Appendix C: Geotechnical and Groundwater Investigation Requirements

### Worksheet C.4-3: Infiltration and Groundwater Protection for Full Infiltration BMPs

Infiltration and Groundwater Protection		Worksheet C.4-3	
Criteria	Question	Yes	No
1	Will the storm water runoff undergo pretreatment such as sedimentation or filtration prior to infiltration?	<input type="checkbox"/>	<input type="checkbox"/>
2	Are pollution prevention and source control BMPs implemented at a level appropriate to protect groundwater quality for areas draining to infiltration BMPs?	<input type="checkbox"/>	<input type="checkbox"/>
3	Is the vertical distance from the base of the full infiltration BMP to the seasonal high groundwater mark greater than 10 feet? This vertical distance may be reduced when the groundwater basin does not support beneficial uses and the groundwater quality is maintained	<input type="checkbox"/>	<input type="checkbox"/>
4	Does the soil through which infiltration is to occur have physical and chemical characteristics that are adequate for proper infiltration durations and treatment of runoff for the protection of groundwater beneficial uses? Refer to Appendix C.3.1.	<input type="checkbox"/>	<input type="checkbox"/>
5	Is the following statement true? Full infiltration BMPs are not used for areas of industrial or light industrial activity, and other high threat to water quality land uses and activities, unless source control BMPs to prevent exposure of high threat activities are implemented, or runoff from such activities is first treated or filtered to remove pollutants prior to infiltration.	<input type="checkbox"/>	<input type="checkbox"/>
6	Is the full infiltration BMP located at a distance greater than 100 feet horizontally from any water supply well?	<input type="checkbox"/>	<input type="checkbox"/>
Basis and Documentation:			
All the answers for Criteria 1 to 6 must be “Yes” for acceptance of a full infiltration BMP.			

## Appendix C: Geotechnical and Groundwater Investigation Requirements

This page was intentionally left blank.

## C.4 Feasibility Screening Exhibits

Table C.4-1 lists the potential sources for feasibility screening information that may be readily available as GIS data sets to assist the project applicant during planning phase.

**Table C.4-1: Feasibility Screening Exhibits**

Figures	Layer	Data Sources
<b>C.1 Soils</b>	Hydrologic Soil Group – A, B, C, D	NRCS Web Soil Survey <a href="http://websoilsurvey.sc.egov.usda.gov/">http://websoilsurvey.sc.egov.usda.gov/</a>
	Hydric Soils	USDA Web Soil Survey. Hydric soils, (ratings of 100) were classified as hydric. <a href="http://websoilsurvey.sc.egov.usda.gov/App/HomePage.htm">http://websoilsurvey.sc.egov.usda.gov/App/HomePage.htm</a>
<b>C.2: Slopes and Geologic Hazards</b>	Slopes >25%	SanGIS <a href="http://www.sangis.org/">http://www.sangis.org/</a>
	Liquefaction Potential	SanGIS <a href="http://www.sangis.org/">http://www.sangis.org/</a>
	Landslide Potential	SanGIS Geologic Hazards layer. Subset of polygons with hazard codes related to landslides were selected. This data is limited to the City of San Diego Boundary. <a href="http://www.sangis.org/">http://www.sangis.org/</a>
<b>C.3: Groundwater Table Elevations</b>	Groundwater Depths	GeoTracker: <a href="http://geotracker.waterboards.ca.gov/data_download_by_county.asp">http://geotracker.waterboards.ca.gov/data_download_by_county.asp</a>
<b>C.4: Contaminated Sites</b>	Contaminated soils and/or groundwater sites	GeoTracker: <a href="http://geotracker.waterboards.ca.gov/">http://geotracker.waterboards.ca.gov/</a>

## Appendix C: Geotechnical and Groundwater Investigation Requirements

This page was intentionally left blank.

Appendix

D

ESCONDIDO STORM WATER DESIGN MANUAL

# Approved Infiltration Rate Assessment Methods for Selection of Storm Water BMPs

# Appendix D Approved Infiltration Rate Assessment Methods for Selection and Design of Storm Water BMPs

## D.1 Introduction

Characterization of potential infiltration rates is a critical step in evaluating the degree to which infiltration reduces storm water runoff volume. This appendix is intended to provide guidance to help answer the following questions:

**1. How and where does infiltration testing fit into the project development process?**

Appendix D.2 discusses the role of infiltration testing in different stages of project development and how to plan a phased investigation approach.

**2. What infiltration rate assessment methods are acceptable?**

Appendix D.3 describes the acceptable infiltration rate assessment methods.

**3. What factors should be considered in selecting the most appropriate testing method for a project?**

Appendix D.4 provides guidance on site-specific considerations that influence which assessment methods are most appropriate.

**4. How should factors of safety be selected and applied for BMP selection and design?**

Appendix D.5 provides guidance for selecting factor of safety.

Note, that this appendix does not consider other feasibility criteria that may make infiltration infeasible, such as groundwater contamination and geotechnical considerations (these are covered in Appendix C). In general, infiltration testing should only be conducted after other feasibility criteria specified in this manual have been evaluated.



## D.2 Role of Infiltration Testing in Different Stages of Project Development

In the process of planning and designing infiltration facilities, there are a number of ways that infiltration testing or estimation factor into project development, as summarized in Table D.2-1. When selecting infiltration testing methods, the geotechnical consultant should select methods applicable to the relevant project phase.

**Table D.2-1 : Role of Infiltration Testing**

Project Phase	Key Questions	General Assessment Strategies
<b>Planning Phase</b>	<p>Where within the project area is infiltration potentially feasible?</p> <p>What volume reduction approaches are potentially suitable for my project?</p>	<p>Use existing data and maps to the extent possible.</p> <p>Use less expensive methods to allow a broader area to be investigated more rapidly.</p> <p>Reach tentative conclusions that are subject to confirmation/refinement at the design phase.</p>
<b>Design Phase</b>	<p>What infiltration rates should be used to design infiltration and biofiltration facilities?</p> <p>What factor of safety should be applied?</p>	<p>Use more rigorous testing methods at specific BMP locations.</p> <p>Support or modify preliminary feasibility findings.</p> <p>Estimate design infiltration rates with appropriate factors of safety.</p>

## D.3 Guidance for Selecting Infiltration Testing Methods

The geotechnical consultant should select appropriate testing methods for the site conditions, subject to the geotechnical consultant’s discretion and approval of the City Engineer, that are adequate to evaluate applicability at each phase of the project (See Table D.3-1):

- At the planning phase, the testing method must be selected to provide a reliable estimate of the locations where infiltration is feasible and allow a reasonably confident determination of infiltration feasibility to support the selection between full infiltration, partial infiltration, and no infiltration BMPs.
- At the design phase, the testing method must be selected to provide a reliable infiltration rate to be used in design. The degree of certainty provided by the selected test should be considered.

Table D.3-1 provides a matrix comparison of these methods. Appendices D.3.1 to D.3.3 provide a summary of each method. This appendix is not intended to be an exhaustive reference on infiltration testing. It does not attempt to discuss every method for testing, nor is it intended to provide step-by-

## Appendix D: Approved Infiltration Rate Assessment Methods

step procedures for each method. The user is directed to supplemental resources (referenced in this appendix) or other appropriate references for more specific information. **Alternative testing standards may be allowed with appropriate rationales and documentation.**

To select an infiltration testing method, it is important to understand how each test is applied and what specific physical properties the test is designed to measure. Infiltration testing methods vary considerably in these regards. For example, a borehole percolation test is conducted by drilling a borehole, filling a portion of the hole with water, and monitoring the rate of fall of the water. This test directly measures the three dimensional flux of water into the walls and bottom of the borehole. An approximate correction is applied to indirectly estimate the vertical infiltration rate from the results of the borehole test. In contrast, a double-ring infiltrometer test is conducted from the ground surface and is intended to provide a direct estimate of vertical (one-dimensional) infiltration rate at this point. Both of these methods are applicable under different conditions.

Submit the field test measurements and tabulated results for each location tested. Submit the calculated infiltration rate and method of calculation. For the purposes of this manual, saturated hydraulic conductivity and infiltration rate may be assumed to be equal.

**Table D.3-1: Comparison of Infiltration Rate Estimation and Testing Methods<sup>18</sup>**

Test	Suitability at Planning Phase	Suitability at Design Phase <sup>19</sup>
<b>NRCS Soil Survey Maps</b>	Yes, but mapped soil types must be confirmed with site observations. Regional soil maps are known to contain inaccuracies at the scale of typical development sites.	Yes, for partial infiltration designs when mapped soils are corroborated with soil samples collected during investigation activities. No, for full infiltration designs.
<b>Grain Size Analysis</b>	Not preferred. Should only be used if a strong correlation has been developed between grain size analysis and measured infiltration rate testing results of site soils.	No
<b>Cone Penetrometer Test (CPT)</b>	Not preferred. Should only be used if a strong correlation has been developed between CPT results and measured infiltration rate testing results of site soils.	No
<b>Simple Open Pit Test</b>	Yes	Yes, with appropriate correction for infiltration into side walls and elevated factor of safety.

---

<sup>18</sup> Percolation rates measured in pit tests and borehole percolation tests should be converted to infiltration rates using the Porchet method (Appendix D.3.4).

<sup>19</sup> Design phase confirmation of infiltration rate is only required if full infiltration BMPs are proposed. Partial infiltration BMPs are not as sensitive to infiltration rate and do not warrant design phase verification.

## Appendix D: Approved Infiltration Rate Assessment Methods

Test	Suitability at Planning Phase	Suitability at Design Phase <sup>19</sup>
<b>Open Pit Falling Head Test</b>	Yes	Yes, with appropriate correction for infiltration into side walls and elevated factor of safety.
<b>Double Ring Infiltrometer Test (ASTM 3385)</b>	Yes	Yes
<b>Single Ring Infiltrometer Test</b>	Yes	Yes
<b>Large-scale Pilot Infiltration Test</b>	Yes, but generally cost prohibitive and too water-intensive for preliminary screening of a large area.	Yes, but should consider relatively large water demand associated with this test.
<b>Smaller-scale Pilot Infiltration Test</b>	Yes	Yes
<b>Well Permeameter Method (USBR 7300-89)</b>	Yes	Yes
<b>Borehole Percolation Tests (various methods)</b>	Yes, reliability of this test can be improved by obtaining a continuous core where tests are conducted.	Yes in areas of proposed cut where other tests are not possible; a boring log should be recorded and used to interpret test; should be confirmed with a more direct measurement following excavation.

Table D.3-2 provides recommendations for number of tests, based on test method, needed to provide adequate characterization of the design phase infiltration rate. Testing must be done at the location and elevation of proposed infiltration BMPs. **This guidance is only applicable for full infiltration BMPs at the design phase. It is not applicable for planning phase investigations or for design of partial infiltration BMPs.** The “low” and “medium” concerns relate to the factor of safety presented in Appendix D.5.

## Appendix D: Approved Infiltration Rate Assessment Methods

**Table D.3-2. Recommended Replicates and Levels of Concern for Design Phase Infiltration Testing for Full Infiltration Designs**

Test Method Category	Small BMPs (BMP area < 250 ft <sup>2</sup> )	Medium BMPs (BMP area < 2,000 ft <sup>2</sup> )	Large BMPs (BMP area > 2,000 ft <sup>2</sup> )
<b>Pit Testing Methods: Large-scale PIT Smaller-scale PIT</b>	2 tests = <b>Low Concern</b>	2+ tests = <b>Low Concern</b>	2 tests per 5,000 ft <sup>2</sup> = <b>Medium Concern</b> 3+ tests per 5,000 ft <sup>2</sup> = <b>Low Concern</b>
<b>Surface Infiltrometer Tests and Smaller Pit Testing Methods: Simple Open Pit Open Pit Falling Head Single Ring Double ring Other surface infiltrometer methods</b>	2 tests = <b>Medium Concern</b> 3+ tests = <b>Low Concern</b>	3 tests = <b>Medium Concern</b> 4+ tests = <b>Low Concern</b>	3 tests per 5,000 ft <sup>2</sup> = <b>Medium Concern</b> 5+ tests per 5,000 ft <sup>2</sup> = <b>Low Concern</b>
<b>Well and Borehole Permeameter Methods (must be accompanied by bore logs to be suitable for design phase)</b>	2 tests = <b>Medium Concern</b> 3+ tests = <b>Low Concern</b>	3 tests = <b>Medium Concern</b> 4+ tests = <b>Low Concern</b>	3 tests per 5,000 ft <sup>2</sup> = <b>Medium Concern</b> 5+ tests per 5,000 ft <sup>2</sup> = <b>Low Concern</b>
<b>Mapping or soil texture methods</b>	Not Acceptable for Full Infiltration Design Phase		

### D.3.1 Desktop Approaches and Data Correlation Methods

This section reviews common methods used to evaluate infiltration characteristics based on desktop-available information, such as GIS data. This section also introduces methods for estimating infiltration properties via correlations with other measurements.

#### D.3.1.1 NRCS Soil Survey Maps

NRCS Soil Survey maps (<http://websoilsurvey.nrcs.usda.gov/app/HomePage.htm>) can be used to estimate preliminary feasibility conditions, specifically by mapping hydrologic soil groups, soil texture classes, and presence of hydric soils relative to the site layout. For planning feasibility determinations, mapped conditions must be supplemented with available data from the site (e.g., soil borings, observed soil textures, biological indicators). For planning feasibility, the presence of C or D soils, if confirmed

## Appendix D: Approved Infiltration Rate Assessment Methods

by available data, provides a reasonable basis to determine that full infiltration is not feasible for a given DMA.

### D.3.1.2 Grain Size Analysis Testing and Correlations to Infiltration Rate

Hydraulic conductivity can be estimated indirectly from correlations with soil grain-size distributions. While this method is approximate, correlations have been relatively well established for some soil conditions. One of the most commonly used correlations between grain size parameters and hydraulic conductivity is the Hazen (1892, 1911) empirical formula (Philips and Kitch, 2011), but a variety of others have been developed. Correlations must be developed based on testing of site-specific soils. For the purposes of this manual, saturated hydraulic conductivity and infiltration rate can be assumed to be equal.

### D.3.1.3 Cone Penetrometer Testing and Correlations to Infiltration Rate

Hydraulic conductivity can also be estimated indirectly from cone penetrometer test (CPT). A cone penetrometer test involves advancing a small probe into the soil and measuring the relative resistance encountered by the probe as it is advanced. The signal returned from this test can be interpreted to yield estimated soil types and the location of key transitions between soil layers. If this method is used, correlations must be developed based on testing of site-specific soils. For the purposes of this manual, saturated hydraulic conductivity and infiltration rate can be assumed to be equal.

## D.3.2 Surface and Shallow Excavation Methods

This section describes tests that are conducted at the ground surface or within shallow excavations close to the ground surface. These tests are generally applicable for cases where the bottom of the infiltration system will be near the existing ground surface. They can also be conducted to confirm the results of borehole methods after excavation/site grading has been completed.

### D.3.2.1 Simple Open Pit Test

The Simple Open Pit Test is most appropriate for planning level screening of infiltration feasibility. Although it is similar to Open Pit Falling Head tests used for establishing a design infiltration rate (see below), the Simple Open Pit Test is less rigorous and is generally conducted to a lower standard of care. This test can be conducted by a nonprofessional as part of planning level screening phase.

The Simple Open Pit Test is a falling head test in which a hole at least two feet in diameter is filled with water to a level of 6" above the bottom. Water level is checked and recorded regularly until either an hour has passed or the entire volume has infiltrated. The test is repeated two more times in succession and the rate at which the water level falls in the third test is used as the percolation rate. Measured percolation rate shall be converted to an infiltration rate using the Porchet method (Appendix D.3.4).

## Appendix D: Approved Infiltration Rate Assessment Methods

This test has the advantage of being inexpensive to conduct, yet it is believed to be fairly reliable for screening as the dimensions of the test are similar, proportionally, to the dimensions of a typical BMP. The key limitations of this test are that it measures a relatively small area, does not necessarily result in a precise measurement, and may not be uniformly implemented.

Source: City of Portland, 2008. Storm water Management Manual

### D.3.2.2 Open Pit Falling Head Test

This test is similar to the Simple Open Pit Test, but covers a larger footprint, includes more specific instructions, returns more precise measurements, and generally should be overseen by a geotechnical professional. Nonetheless, it remains a relatively simple test.

To perform this test, a hole is excavated at least 2 feet wide by 4 feet long (larger is preferred) and to a depth of at least 12 inches. The bottom of the hole should be approximately at the depth of the proposed infiltrating surface of the BMP. The hole is pre-soaked by filling it with water at least a foot above the soil to be tested and leaving it at least 4 hours (or overnight if clays are present). After pre-soaking, the hole is refilled to a depth of 12 inches and allowed to drain for one hour (2 hours for slower soils), while measuring the rate at which the water level drops. The test is then repeated until successive trials yield a result with less than a 10 percent change.

In comparison to a double-ring infiltrometer, this test has the advantage of measuring infiltration over a larger area and better resembles the dimensionality of a typical small scale BMP. Because it includes both vertical and lateral infiltration, it should be adjusted to estimate design rates for larger scale BMPs.

### D.3.2.3 Double Ring Infiltrometer Test (ASTM 3385)

The Double Ring Infiltrometer was originally developed to estimate the infiltration rate of low permeability materials, such as clay liners for ponds, but has seen significant use in storm water applications. The most recent revision of this method from 2009 is known as ASTM 3385-09. The testing apparatus is designed with concentric rings that form an inner ring and an annulus between the inner and outer rings. Infiltration from the annulus between the two rings is intended to saturate the soil outside of the inner ring such that infiltration from the inner ring is restricted primarily to the vertical direction.

To conduct this test, both the center ring and annulus between the rings are filled with water. There is no pre-wetting of the soil in this test. However, a constant head of 1 to 6 inches is maintained for 6 hours, or until a constant flow rate is established. Both the inner flow rate and annular flow rate are recorded, if they are different, the inner flow rate should be used. There are a variety of approaches that are used to maintain a constant head on the system, including use of a Mariotte tube, constant level float valves, or manual observation and filling. This test must be conducted at the elevation of the proposed infiltrating surface; therefore application of this test is limited in cases where the infiltration surface is a significant distance below existing grade at the time of testing.

However, given the small diameter of the inner ring (standard diameter is 12 inches, but it can be

## Appendix D: Approved Infiltration Rate Assessment Methods

larger), this test only measures infiltration rate in a small area. Additionally, given the small quantity of water used in this test compared to larger scale tests, this test may be biased high in cases where the long term infiltration rate is governed by groundwater mounding and the rate at which mounding dissipates (i.e., the capacity of the infiltration receptor). Finally, the added effort and cost of isolating the vertical infiltration rate may not necessarily be warranted considering that BMPs typically have a lateral component of infiltration as well. Therefore, while this method has the advantages of being technically rigorous and well standardized, it should not necessarily be assumed to be the most representative test for estimating full-scale infiltration rates. Source: American Society for Testing and Materials (ASTM) International (2009)

### D.3.2.4 Single Ring Infiltrometer Test

The single ring infiltrometer test is not a standardized ASTM test, however it is a relatively well-controlled test and shares many similarities with the ASTM standard double ring infiltrometer test (ASTM 3385-09). This test is a constant head test using a large ring (preferably greater than 40 inches in diameter) usually driven 12 inches into the soil. Water is ponded above the surface. The rate of water addition is recorded and infiltration rate is determined after the flow rate has stabilized. Water can be added either manually or automatically.

The single ring used in this test tends to be larger than the inner ring used in the double ring test. Driving the ring into the ground limits lateral infiltration; however some lateral infiltration is generally considered to occur. Experience in Riverside County (CA) has shown that this test gives results that are similar to full-scale infiltration facilities. The primary advantages of this test are that it is relatively simple to conduct and has a larger footprint (compared to the double-ring method), restricts horizontal infiltration and is more standardized (compared to open pit methods). However, it is still a relatively small scale test and can only be reasonably conducted near the existing ground surface.

### D.3.2.5 Large-scale Pilot Infiltration Test

As its name implies, this test is closer in scale to a full-scale infiltration facility. This test was developed by the Washington State Department of Ecology specifically for storm water applications.

To perform this test, a test pit is excavated with a horizontal surface area of roughly 100 square feet to a depth that allows 3 to 4 feet of ponding above the expected bottom of the infiltration facility. Water is continually pumped into the system to maintain a constant water level (between 3 and 4 feet above the bottom of the pit, but not more than the estimated water depth in the proposed facility) and the flow rate is recorded. The test is continued until the flow rate stabilizes. Infiltration rate is calculated by dividing the flow rate by the surface area of the pit. Similar to other open pit test, this test is known to result in a slight bias high because infiltration also moves laterally through the walls of the pit during the test. The Washington State Department of Ecology requires a correction factor of 0.75 (factor of safety of 1.33) be applied to results.

This test has the advantage of being more resistant to bias from localized soil variability and being more similar to the dimensionality and scale of full scale BMPs. It is also more likely to detect long

## Appendix D: Approved Infiltration Rate Assessment Methods

term decline in infiltration rates associated with groundwater mounding. As such, it remains the preferred test for establishing design infiltration rates in Western Washington (Washington State Department of Ecology, 2012). In a comparative evaluation of test methods, this method was found to provide a more reliable estimate of full-scale infiltration rate than double ring infiltrometer and borehole percolation tests (Philips and Kitch 2011).

The difficulty encountered in this method is that it requires a larger area be excavated than the other methods, and this in turn requires larger equipment for excavation and a greater supply of water. However, this method should be strongly considered when less information is known about spatial variability of soils and/or a higher degree of certainty in estimated infiltration rates is desired.

Source: Washington State Department of Ecology, 2012.

### D.3.2.6 Smaller-scale Pilot Infiltration Test

The smaller-scale pilot infiltration test (PIT) is conducted similarly to the large-scale PIT but involves a smaller excavation, ranging from 20 to 32 square feet instead of 100 square feet for the large-scale PIT, with similar depths. The primary advantage of this test compared to the full-scale PIT is that it requires less excavation volume and less water. It may be more suitable for small-scale distributed infiltration controls where the need to conduct a greater number of tests outweighs the accuracy that must be obtained in each test, and where groundwater mounding is not as likely to be an issue. Washington State Department of Ecology establishes a correction factor of 0.5 (factor of safety of 2.0) for this test in comparison to 0.75 (factor of safety of 1.33) for the large-scale PIT to account for a greater fraction of water infiltrating through the walls of the excavation and lower degree of certainty related to spatial variability of soils.

### D.3.3 Deeper Subsurface Tests

#### D.3.3.1 Well Permeameter Method (USBR 7300-89)

Well permeameter methods were originally developed for purposes of assessing aquifer permeability and associated yield of drinking water wells. This family of tests is most applicable in situations in which infiltration facilities will be placed substantially below existing grade, which limits the use of surface testing methods.

In general, this test involves drilling a 6 inch to 8 inch test well to the depth of interest and maintaining a constant head until a constant flow rate has been achieved. Water level is maintained with down-hole floats. The Porchet method (Appendix D.3.4) or the nomographs provided in the USBR Drainage Manual (United States Department of the Interior, Bureau of Reclamation, 1993) are used to convert the measured rate of percolation to an estimate of vertical hydraulic conductivity. A smaller diameter boring may be adequate, however this then requires a different correction factor to account for the increased variability expected.

While these tests have applicability in screening level analysis, considerable uncertainty is introduced



## Appendix D: Approved Infiltration Rate Assessment Methods

in the step of converting direct percolation measurements to estimates of vertical infiltration. Additionally, this testing method is prone to yielding erroneous results in cases where the vertical horizon of the test intersects with minor lenses of sandy soils that allow water to dissipate laterally at a much greater rate than would be expected in a full-scale facility. To improve the interpretation of this test method, a bore log should be inspected to determine whether thin lenses of material may be biasing results at the strata where testing is conducted. Consult USBR procedure 7300-89 for more details.

Source: (United States Department of the Interior, Bureau of Reclamation, 1990, 1993)

### D.3.3.2 Borehole Percolation Tests (various methods)

Borehole percolation tests were originally developed as empirical tests to estimate the capacity of onsite sewage disposal systems (septic system leach fields), but have more recently been adopted into use for evaluating storm water infiltration. Similar to the well permeameter method, borehole percolation methods primarily measure lateral infiltration into the walls of the boring and are designed for situations in which infiltration facilities will be placed well below current grade. The percolation rate obtained in this test should be converted to an infiltration rate using a technique such as the Porchet method (Appendix D.3.4).

This test is generally implemented similarly to the USBR Well Permeameter Method. Per the Riverside County Borehole Percolation method, a hole is bored to a depth at least 5 times the borehole radius. The hole is presoaked for 24 hours (or at least 2 hours if sandy soils with no clay). The hole is filled to approximately the anticipated top of the proposed infiltration basin. Rates of fall are measured for six hours, refilling each half hour (or 10 minutes for sand). Tests are generally repeated until consistent results are obtained.

The same limitations described for the well permeameter method apply to borehole percolation tests, and their applicability is generally limited to initial screening. To improve the interpretation of this test method, a continuous soil core can be extracted from the hole and below the test depth, following testing, to determine whether thin lenses of material may be biasing results at the strata where testing is conducted.

Sources: Riverside County Percolation Test (2011), California Test 750 (Caltrans, 1986), San Bernardino County Percolation Test (1992); USEPA Falling Head Test (USEPA, 1980).

### D.3.4 Percolation Rate Conversion Example

Measured percolation rate should be converted to an infiltration rate using the Porchet method (aka Inverse Borehole Method). See example below for the conversion.

<b>Given:</b>
<ul style="list-style-type: none"> <li>• Time interval, <math>\Delta t = 10</math> minutes</li> <li>• Initial depth to water, <math>D_o = 12.25</math> inches</li> <li>• Final depth to water, <math>D_f = 13.75</math> inches</li> <li>• Total depth of test hole, <math>D_T = 60</math> inches</li> <li>• Test hole radius<sup>1</sup>, <math>r = 4</math> inches</li> </ul>
<b>Required:</b>
<ul style="list-style-type: none"> <li>• Determine the tested infiltration rate based on Porchet's method.</li> </ul>
<b>Solution:</b>
<ol style="list-style-type: none"> <li>1. Solve for the height of water at the beginning of the selected time interval, <math>H_o</math>:  <math display="block">H_o = D_T - D_o = 60 - 12.25 = 47.75 \text{ inches}</math> </li> <li>2. Solve for the height of water at the end of the selected time interval, <math>H_f</math>:  <math display="block">H_f = D_T - D_f = 60 - 13.75 = 46.25 \text{ inches}</math> </li> <li>3. Solve for the change in height of water over the selected time interval, <math>\Delta H</math>:  <math display="block">\Delta H = H_o - H_f = 47.75 - 46.25 = 1.50 \text{ inches}</math> </li> <li>4. Calculate the average head over the selected time interval, <math>H_{avg}</math>:  <math display="block">H_{avg} = \frac{H_o + H_f}{2} = \frac{47.75 + 46.25}{2} = 47.00 \text{ inches}</math> </li> <li>5. Calculate the tested infiltration rate, <math>I_t</math>, using the following equation:  <math display="block">I_t = \frac{\Delta H(60r)}{\Delta t(r + 2H_{avg})} = \frac{(1.50 \text{ in}) \left(60 \frac{\text{min}}{\text{hr}}\right) (4 \text{ in})}{(10 \text{ min})((4 \text{ in}) + 2(47 \text{ in}))} = 0.37 \text{ in/hr}</math> </li> </ol>

**Notes:**

<sup>1</sup>The equivalent radius should be determined for rectangular holes based on the area of the rectangular test hole (i.e.,  $r=(A/\pi)^{0.5}$ )

### D.4 Specific Considerations for Infiltration Testing

The following subsections are intended to address specific topics that commonly arise in characterizing infiltration rates.

#### D.4.1 Hydraulic Conductivity versus Infiltration Rate versus Percolation Rate

A common misunderstanding is that the “percolation rate” obtained from a percolation test is equivalent to the “infiltration rate” obtained from tests such as a single or double ring infiltrometer test which is equivalent to the “saturated hydraulic conductivity”. In fact, these terms have different meanings. Saturated hydraulic conductivity is an intrinsic property of a specific soil sample under a given density. It is a coefficient in Darcy’s equation (Darcy 1856) that characterizes the flux of water that will occur under a given gradient. The measurement of saturated hydraulic conductivity in a laboratory test is typically referred to as “permeability”, which is a function of the density, structure, stratification, fines, and discontinuities of a given sample under given controlled conditions. In contrast, infiltration is the downward entry of water into the soil. The velocity at which water enters the soil is infiltration rate. Infiltration rate is typically expressed in inches per hour. For the purposes of this manual, saturated hydraulic conductivity and infiltration rate can be assumed to be equal. Similarly, to permeability, infiltration rate can be limited by a number of factors including the layering of soil, density, discontinuities, and initial moisture content. These factors control how quickly water can move through a soil. However, infiltration rate can also be influenced by mounding of groundwater, and the rate at which water dissipates horizontally below a BMP – both of which describe the “capacity” of the “infiltration receptor” to accept this water over an extended period. For this reason, an infiltration test should ideally be conducted for a relatively long duration resembling a series of storm events so that the capacity of the infiltration receptor is evaluated as well as the rate at which water can enter the system. Infiltration rates are generally tested with larger diameter holes, pits, or apparatuses intended to enforce a primarily vertical direction of flux.

In contrast, percolation is tested with small diameter holes, and it is mostly a lateral phenomenon. The direct measurement yielded by a percolation test tends to overestimate the infiltration rate, except perhaps in cases in which a BMP has similar dimensionality to the borehole, such as a dry well. Adjustment of percolation rates may be made to an infiltration rate using a technique such as the Porchet Method.

#### D.4.2 Cut and Fill Conditions

**Cut Conditions:** Where the proposed infiltration BMP is to be located in a cut condition, the infiltration surface level at the bottom of the BMP might be far below the existing grade. For example,

## Appendix D: Approved Infiltration Rate Assessment Methods

if the infiltration surface of a proposed BMP is to be located at an elevation that is currently beneath 15 feet of planned cut, how can the proposed infiltration surface be tested to establish a design infiltration rate prior to beginning excavation? The question can be addressed in two ways: First, one of the deeper subsurface tests described above can be used to provide a planning level screening of potential rates at the elevation of the proposed infiltrating surface. These tests can be conducted at depths exceeding 100 feet, and therefore are applicable in most cut conditions. Second, the project can commit to further testing using more reliable methods following bulk excavation to refine or adjust infiltration rates, and/or apply higher factors of safety to borehole methods to account for the inherent uncertainty in these measurements and conversions.

**Fill Conditions:** Materials that are placed to construct grade are referred to as fill. Mechanically placed fill soil constructed in accordance with current standards is referred to as engineered compacted fill or structural fill. Per current standards, the placement and compaction of the fill soil is monitored and tested for quality assurance, and reported in an “as-graded” geotechnical report. Mechanically placed fill constructed prior to the current standards may or may not have been properly documented. Suitability of these fills for an intended use must be investigated by a geotechnical professional. Fill materials have also been placed locally that are not constructed in accordance with any standard and without any quality control. These fills soils are referred to as undocumented fill or as an uncontrolled embankment.

Infiltration rates and subsurface water flow pathways in fill soils can vary based on the soil properties, placement, and compaction of the fill. Select grading using soils with uniform properties can result in fills with predictable infiltration characteristics. More commonly, however, soils from different sources are mixed and/or stratified resulting in unpredictable infiltration characteristics and subsurface flow pathways.

If the bottom of a BMP (infiltration surface) is proposed to be located in a planned fill location, the infiltration surface may not exist prior to grading. How then can the infiltration rate be determined? For example, if a proposed infiltration BMP is to be located with its bottom elevation in 5 feet of fill, how could one reasonably establish an infiltration rate prior to the fill being placed?

Where possible, infiltration BMPs on planned fill materials should be designed such that their infiltrating surface extends into native soils. Additionally, for shallow fill depths, fill material can be selectively graded (i.e., high permeability granular material placed below proposed BMPs) to provide reliable infiltration properties until the infiltrating water reaches native soils. In some cases, due to considerable fill depth, the extension of the BMP down to natural soil and/or selective grading of fill material may prove infeasible. In addition, placement of fill material with heavy equipment may result in some compaction of now buried native soils potentially reducing their ability to infiltrate. In these cases, because of the uncertainty of fill parameters as described above as well as potential compaction of the native soils, an infiltration BMP may not be feasible.

## Appendix D: Approved Infiltration Rate Assessment Methods

If the planned fill material is known to be of a granular nature and that the native soils below is permeable and will not be highly compacted, infiltration through compacted fill materials may still be feasible. In this case, a project phasing or selective grading approach could be used including the following general steps, (1) collect samples from areas expected to be used as borrow sites for fill activities, (2) remold samples to approximately the proposed degree of compaction and measure the saturated hydraulic conductivity of remolded samples using laboratory methods, (3) if infiltration rates appear adequate for infiltration, then apply an appropriate factor of safety and use the initial rates for preliminary design, (4) following placement of fill, conduct in-situ testing to refine design infiltration rates and adjust the design as needed; the infiltration rate of native soil below the fill should also be tested at this time to determine if compaction as a result of fill placement has significantly reduced its infiltration rate.

The project geotechnical engineer shall be involved in decision making whenever infiltration is proposed in the vicinity of engineered compacted fill supporting structures or improvements so that potential impacts of infiltration can be evaluated. No full infiltration or partial infiltration BMPs shall be used in existing fills greater than 5 feet thick unless approved by the project geotechnical engineer. In fills 5 feet or less, full infiltration or partial infiltration may reasonably be achieved beneath fill. Full or partial Infiltration BMPs proposed within fills 5 feet or less must be evaluated by a geotechnical professional.

### D.4.3 Effects of Direct and Incidental Compaction

It is widely recognized that compaction of soil has a major influence on infiltration rates (Pitt et al. 2008). However, direct (intentional) compaction is an essential aspect of project construction and indirect compaction (such as by movement of machinery, placement of fill, stockpiling of materials, and foot traffic) can be difficult to avoid in some parts of the project site. Infiltration testing strategies should attempt to measure soils at a degree of compaction that resembles anticipated post-construction conditions.

Ideally, infiltration systems should be located outside of areas where direct compaction will be required and should be staked off to minimize incidental compaction from vehicles and stockpiling. For these conditions, no adjustment of test results is needed.

However, in some cases, infiltration BMPs will be constructed in areas to be compacted. For these areas, it may be appropriate to include field compaction tests or prepare laboratory samples and conduct infiltration testing to approximate the degree of compaction that will occur in post-construction conditions. Alternatively, testing could be conducted on undisturbed soil, and an additional factor of safety could be applied to account for anticipated infiltration after compaction. To develop a factor of safety associated with incidental compaction, samples could be compacted to various degrees of compaction, their hydraulic conductivity measured, and a “response curve”

## Appendix D: Approved Infiltration Rate Assessment Methods

developed to relate the degree of compaction to the hydraulic conductivity of the material.

### D.4.4 Temperature Effects on Infiltration Rate

The rate of infiltration through soil is affected by the viscosity of water, which in turn is affected by the temperature of water. As such, infiltration rate is strongly dependent on the temperature of the infiltrating water (Cedergren, 1997). For example, Emerson (2008) found that wintertime infiltration rates below a BMP in Pennsylvania were approximately half their peak summertime rates. As such, it is important to consider the effects of temperature when planning tests and interpreting results.

If possible, testing should be conducted at a temperature that approximates the typical runoff temperatures for the site during the times when rainfall occurs. If this is not possible, then the results of infiltration tests should be adjusted to account for the difference between the temperature at the time of testing and the typical temperature of runoff when rainfall occurs. The measured infiltration can be adjusted by the ratio of the viscosity at the test temperature versus the typical temperature when rainfall occurs (Cedergren, 1997), per the following formula:

#### Equation D.4-1: Measured Infiltration Adjustment

$$K_{\text{Typical}} = K_{\text{Test}} \times \left( \frac{\mu_{\text{Test}}}{\mu_{\text{Typical}}} \right)$$

where:

$K_{\text{Typical}}$	=	the typical infiltration rate expected at typical temperatures when rainfall occurs
$K_{\text{Test}}$	=	the infiltration rate measured or estimated under the conditions of the test
$\mu_{\text{Typical}}$	=	the viscosity of water at the typical temperature expected when rainfall occurs
$\mu_{\text{Test}}$	=	the viscosity of water at the temperature at which the test was conducted

### D.4.5 Number of Infiltration Tests Needed

The heterogeneity inherent in soils implies that all but the smallest proposed infiltration facilities would benefit from infiltration tests in multiple locations. The following requirements apply for in situ infiltration/percolation testing for full infiltration BMPs:

- For the design phase, in situ infiltration testing shall be conducted at a minimum of two

## Appendix D: Approved Infiltration Rate Assessment Methods

locations within 50-feet of each proposed storm water infiltration BMP.

- In situ infiltration testing shall be conducted using an approved method listed in Table D.3-1
- For the design phase, testing shall be conducted at approximately the same depth and in the same material as the base of the proposed storm water BMP.

### D.5 Selecting a Safety Factor

Monitoring of actual facility performance has shown that the full-scale infiltration rate can be much lower than the rate measured by small-scale testing (King County Department of Natural Resources and Parks, 2009). Factors such as soil variability and groundwater mounding may be responsible for much of this difference.

Should I use a factor of safety for design infiltration rate?

Additionally, the infiltration rate of BMPs naturally declines between maintenance cycles as the BMP surface becomes occluded and particulates accumulate in the infiltrative layer.

In the past, infiltration structures have been shown to have a relatively short lifespan. Over 50 percent of infiltration systems either partially or completely failed within the first 5 years of operation (United States EPA, 1999). In a Maryland study on infiltration trenches (Lindsey et al. 1991), 53 percent were not operating as designed, 36 percent were clogged, and 22 percent showed reduced filtration. In a study of 12 infiltration basins (Galli 1992), none of which had built-in pretreatment systems, all had failed within the first two years of operation.

Given the known potential for infiltration BMPs to degrade or fail over time, an appropriate factor of safety applied to infiltration testing results is required for full infiltration. This section presents a recommended thought process for selecting a safety factor for full infiltration systems. This method considers factor of safety to be a function of:

- Site suitability considerations, and
- Design-related considerations.

These factors and the method for using them to compute a safety factor are discussed below. Importantly, this method encourages rigorous site investigation, good pretreatment, and commitments to routine maintenance to provide technically-sound justification for using a lower factor of safety.

#### D.5.1 Determining Factor of Safety

Worksheet D.5-1 (Form I-9), at the end of this section can be used in conjunction with Tables D.5-1 and D.5-2 to determine an appropriate safety factor for design phase for full infiltration BMPs. A factor of safety of 2 must be used for partial infiltration BMPs. Tables D.5-1 and D.5-2 assign point values to design considerations; the values are entered into Worksheet D.5-1 (Form I-9), which assign

## Appendix D: Approved Infiltration Rate Assessment Methods

a weighting factor for each design consideration.

The following procedure can be used to estimate an appropriate factor of safety to be applied to the infiltration testing results for full infiltration BMPs during the design phase. When assigning a factor of safety, care should be taken to understand what other factors of safety are implicit in other aspects of the design to avoid incorporating compounding factors of safety that may result in significant over-design.

1. For each consideration shown above, determine whether the consideration is a high, medium, or low concern.
2. For all high concerns in Table D.5-1, assign a factor value of 3, for medium concerns, assign a factor value of 2, and for low concerns assign a factor value of 1.
3. Multiply each of the factors in Table D.5-1 by 0.25 and then add them together. This should yield a number between 1 and 3.
4. For all high concerns in Table D.5-2, assign a factor value of 3, for medium concerns, assign a factor value of 2, and for low concerns assign a factor value of 1.
5. Multiply the first factor in Table D.5-2 by 0.5, the remaining two factors in Table D.5-2 by 0.25 and then add them together. This should yield a number between 1 and 3.
6. Multiply the two safety factors together to get the final combined safety factor. If the combined safety factor is less than 2, then 2 should be used as the safety factor.
7. Divide the tested infiltration rate by the combined safety factor to obtain the adjusted design infiltration rate for use in sizing the infiltration facility.

**Note:** The minimum combined adjustment factor should not be less than 2.0 and the maximum combined adjustment factor should not exceed 9.0.

### D.5.2 Site Suitability Considerations for Selection of an Infiltration Factor of Safety

Considerations related to site suitability include:

- Soil assessment methods – the site assessment extent (e.g., number of borings, test pits, etc.) and the measurement method used to estimate the short-term infiltration rate.
- Predominant soil texture/percent fines – soil texture and the percent of fines can influence the potential for clogging. Finer grained soils may be more susceptible to clogging.
- Site soil variability – sites with spatially heterogeneous soils (vertically or horizontally) as determined from site investigations are more difficult to estimate average properties for resulting in a higher level of uncertainty associated with initial estimates.
- Depth to seasonal high groundwater/impervious layer – groundwater mounding may become an issue during excessively wet conditions where shallow aquifers or shallow clay lenses are present.



## Appendix D: Approved Infiltration Rate Assessment Methods

These considerations are summarized in Table D.5-1 below, in addition to presenting classification of concern.

**Table D.5-1: Suitability Assessment Related Considerations for Full Infiltration Facility Safety Factors**

Consideration	High Concern – 3 points	Medium Concern – 2 points	Low Concern – 1 point
<b>Assessment methods</b>	Refer to Table D.3-2 for guidance related to selecting levels of concern based on testing methods, test replicates, and infiltration BMP size.		
<b>Texture Class</b>	Silty and clayey soils with significant fines	Loamy soils	Granular to slightly loamy soils
<b>Site soil variability</b>	Highly variable soils indicated from site assessment, or unknown variability	Soil borings/test pits indicate moderately homogeneous soils	Soil borings/test pits indicate relatively homogeneous soils
<b>Depth to groundwater/impervious layer</b>	<5 ft below facility bottom	5-15 ft below facility bottom	>15 below facility bottom

### D.5.3 Design Related Considerations for Selection of an Infiltration Factor of Safety

Design related considerations include:

- Level of pretreatment and expected influent sediment loads – credit should be given for good pretreatment to account for the reduced probability of clogging from high sediment loading. **Appendix B.6** describes performance criteria for “flow-thru treatment” based on 80 percent capture of total suspended solids, which provides excellent levels of pretreatment. Additionally, the Washington State Technology Acceptance Protocol-Ecology provides a certification for “pre-treatment” based on 50 percent removal of TSS, which provides moderate levels of treatment. Current approved technologies are listed at: <http://www.ecy.wa.gov/programs/wq/stormwater/newtech/technologies.html>. Use of certified technologies can allow a lower factor of safety. Also, facilities designed to capture runoff from relatively clean surfaces such as rooftops are likely to see low sediment loads and therefore may be designed with lower safety factors. Finally, the amount of landscaped area and its vegetation coverage characteristics should be considered. For example, in arid areas with more soils exposed, open areas draining to infiltration systems may contribute excessive sediments.
- Compaction during construction – proper construction oversight is needed during construction to ensure that the bottoms of infiltration facility are not impacted by

## Appendix D: Approved Infiltration Rate Assessment Methods

significant incidental compaction. Facilities that use proper construction practices and oversight need less restrictive safety factors.

**Table D.5-2: Design Related Considerations for Infiltration Facility Safety Factors**

Consideration	High Concern – 3 points	Medium Concern – 2 points	Low Concern – 1 point
<b>Level of pretreatment/ expected influent sediment loads</b>	Limited pretreatment using gross solids removal devices only, such as hydrodynamic separators, racks and screens AND tributary area includes landscaped areas, steep slopes, high traffic areas, road sanding, or any other areas expected to produce high sediment, trash, or debris loads.	Good pretreatment with BMPs that mitigate coarse sediments such as vegetated swales AND influent sediment loads from the tributary area are expected to be moderate (e.g., low traffic, mild slopes, stabilized pervious areas, etc.).  Performance of pretreatment consistent with “pretreatment BMP performance criteria” (50% TSS removal) in Appendix B.6	Excellent pretreatment with BMPs that mitigate fine sediments such as bioretention or media filtration OR sedimentation or facility only treats runoff from relatively clean surfaces, such as rooftops/non-sanded road surfaces.  Performance of pretreatment consistent with “flow-thru treatment control BMP performance criteria” (i.e., 80% TSS removal) in Appendix B.6
<b>Redundancy/ resiliency</b>	No “backup” system is provided; the system design does not allow infiltration rates to be restored relatively easily with maintenance	The system has a backup pathway for treated water to discharge if clogging occurs <u>or</u> infiltration rates can be restored via maintenance.	The system has a backup pathway for treated water to discharge if clogging occurs <u>and</u> infiltration rates can be relatively easily restored via maintenance.
<b>Compaction during construction</b>	Construction of facility on a compacted site or increased probability of unintended/ indirect compaction.	Medium probability of unintended/ indirect compaction.	Equipment traffic is effectively restricted from infiltration areas during construction and there is low probability of unintended/ indirect compaction.

### D.5.4 Implications of a Factor of Safety in BMP Feasibility and Design

The above method will provide safety factors for full infiltration systems in the range of 2 to 9. From a simplified practical perspective, this means that the size of the facility will need to increase in area from 2 to 9 times relative to that which might be used without a safety factor. It is also possible that some facilities that were deemed feasible during full infiltration screening (Affirmative response to Criteria 1 in Worksheet C.4-1) may be deemed infeasible during design phase investigations. Clearly, numbers toward the upper end of this range will make all but the best locations prohibitive in land area, cost, and feasibility.

In order to make full infiltration BMPs more feasible and cost effective, steps should be taken to plan and execute the implementation of infiltration BMPs in a way that will reduce the safety factors needed for those projects. A commitment to effective site design and source control through site investigation, use of effective pretreatment controls, good construction practices, and restoration of the infiltration rates of soils that are damaged by prior compaction should lower the safety factor that should be applied, to help improve the long term reliability of the system and reduce BMP construction cost. While these practices decrease the recommended safety factor, they do not totally mitigate the need to apply a factor of safety. The minimum recommended safety factor of 2.0 is intended to account for the remaining uncertainty and long-term deterioration that cannot be technically mitigated.

Partial infiltration BMPs shall use a factor of safety of 2 for both the feasibility screening and design phase rather than a factor of safety determined using the method below. Partial infiltration BMPs are less sensitive and more resilient to uncertainties in true infiltration because water that does not infiltrate into underlying soils is discharged after being treated through bioretention soil media.

#### Summary of factor of safety selection:

- **During Planning Phase:** A factor of safety of 2.0 must be used to estimate the infiltration rate to categorize the infiltration feasibility condition of the DMA (when completing Worksheet C.4-1: Form I-8) and to estimate the percentage of volume reduction required when the DMA is classified as “Partial Infiltration Condition”.
- **During Design Phase:** During the design phase, Worksheet D.5-1: Form I-9 must be used to calculate the factor of safety and design infiltration rate to design full infiltration BMPs. If the calculated combined factor of safety is less than 2, then a safety factor of 2 must be used to calculate the design infiltration rate. Partial infiltration BMP designs shall use a factor of safety of 2 for the design phase.

**Note:** If the observed infiltration rate is greater than or equal to 1 inches/hr. and the design infiltration rate calculated using Worksheet D.5-1 is less than or equal to 0.5 inches/hr. then the applicant may choose to implement partial infiltration BMPs.

## Appendix D: Approved Infiltration Rate Assessment Methods

### Worksheet D.5-1: Factor of Safety and Design Infiltration Rate Worksheet for Full Infiltration Designs

Factor of Safety and Design Infiltration Rate Worksheet			Worksheet D.5-1: Form I-9		
Factor Category		Factor Description	Assigned Weight (w)	Factor Value (v)	Product (p) $p = w \times v$
A	Suitability Assessment	Soil assessment methods	0.25		
		Predominant soil texture	0.25		
		Site soil variability	0.25		
		Depth to groundwater / impervious layer	0.25		
		Suitability Assessment Safety Factor, $S_A = \Sigma p$			
B	Design	Level of pretreatment/ expected sediment loads	0.5		
		Redundancy/resiliency	0.25		
		Compaction during construction	0.25		
		Design Safety Factor, $S_B = \Sigma p$			
Combined Safety Factor, $S_{total} = S_A \times S_B$ [Minimum of 2 and Maximum of 9]					
Observed Infiltration Rate, inch/hr., $K_{observed}$ (corrected for test-specific bias) Note: This worksheet is only applicable when the observed infiltration rate is greater than or equal to 1 inch/hr.					
Design Infiltration Rate, in/hr., $K_{design} = K_{observed} / S_{total}$ Note: If the estimated design infiltration rate is less than or equal to 0.5 inch/hr. then the applicant may choose to implement partial infiltration BMPs.					
Supporting Data					
Briefly describe infiltration test and provide reference to test forms:					

**Note:** Worksheet D.5-1: Form I-9 is only applicable to design BMPs in “full infiltration condition”. This form is not applicable for categorization of infiltration feasibility (Worksheet C.4-1: Form I-8) and/or for designing BMPs in “partial infiltration condition” or “no infiltration condition”.

## Appendix D: Approved Infiltration Rate Assessment Methods

This page was intentionally left blank.

Appendix

E

ESCONDIDO STORM WATER DESIGN MANUAL

# BMP Design Fact Sheets

# Appendix E BMP Design Fact Sheets

The following fact sheets were developed to assist the project applicants with designing BMPs to meet the storm water obligations. The Fact Sheet Quick Guide on the next page summarizes the layout and type of information contained in each fact sheet.

MS4 Category	Manual Category	Design Fact Sheet	App.	Pg.
Source Control	Source Control	SC-A to SC-P: Source Control BMP Requirements	E.1	E-4
		SC-Q: Large Trash Generating Facilities	E.2	E-16
		SC-R: Animal Facilities	E.3	E-20
		SC-S: Plan Nurseries and Gardens	E.4	E-21
		SC-T: Automotive Facilities	E.5	E-22
Site Design	Site Design	SD-A: Tree Wells	E.6	E-24
		SD-B: Impervious Area Dispersion	E.7	E-33
		SD-C: Green Roofs	E.8	E-40
		SD-D: Permeable Pavement (Site Design BMP)	E.9	E-47
		SD-E: Rain Barrels	E.10	E-53
		SD-F: Amended Soils	E.11	E-57
Retention	Harvest and Use	HU-1: Cistern	E.12	E-60
	Infiltration	INF-1: Infiltration Basins	E.13	E-68
		INF-2: Bioretention	E.14	E-78
		INF-3: Permeable Pavement (Pollutant Control)	E.15	E-91
		INF-4: Dry Wells	E.16	E-105
	Partial Retention	PR-1: Biofiltration with Partial Retention	E.17	E-106
Biofiltration	Biofiltration	BF-1: Biofiltration	E.18	E-120
		BF-2: Nutrient Sensitive Media Design	E.19	E-134
		BF-3: Proprietary Biofiltration	E.20	E-137
Flow-thru Treatment Control	Flow-thru Treatment Control with Alternative Compliance	FT-1: Vegetated Swales	E.21	E-138
		FT-2: Media Filters	E.22	E-148
		FT-3: Sand Filters	E.23	E-155
		FT-4: Dry Extended Detention Basin	E.24	E-165
		FT-5: Proprietary Flow-thru Treatment Control	E.25	E-175
-	-	PL: Plant List	E.26	E-176
		SL: Sediment Loading	E.27	E-177

## Fact Sheet Quick Guide

BF-1 Biofiltration	1	<table border="1"> <tr> <td data-bbox="971 338 1369 403">MS4 Permit Category</td> <td data-bbox="1369 338 1445 403">2</td> </tr> <tr> <td colspan="2" data-bbox="971 403 1445 468">Biofiltration</td> </tr> <tr> <td data-bbox="971 468 1369 533">Manual Category</td> <td data-bbox="1369 468 1445 533"></td> </tr> <tr> <td colspan="2" data-bbox="971 533 1445 598">Biofiltration</td> </tr> <tr> <td data-bbox="971 598 1369 663">Applicable Performance Standard</td> <td data-bbox="1369 598 1445 663"></td> </tr> <tr> <td colspan="2" data-bbox="971 663 1445 728">Pollutant Control</td> </tr> <tr> <td colspan="2" data-bbox="971 728 1445 793">Flow Control</td> </tr> <tr> <td data-bbox="971 793 1369 858">Primary Benefits</td> <td data-bbox="1369 793 1445 858"></td> </tr> <tr> <td colspan="2" data-bbox="971 858 1445 903">Treatment</td> </tr> </table>	MS4 Permit Category	2	Biofiltration		Manual Category		Biofiltration		Applicable Performance Standard		Pollutant Control		Flow Control		Primary Benefits		Treatment	
MS4 Permit Category	2																			
Biofiltration																				
Manual Category																				
Biofiltration																				
Applicable Performance Standard																				
Pollutant Control																				
Flow Control																				
Primary Benefits																				
Treatment																				
		3																		
<p>Location: 43<sup>rd</sup> Street and Logan Avenue, San Diego, California</p>																				

<b>Description</b>	4
<p>Biofiltration (Bioretention with underdrain) facilities are vegetated surface water systems that filter water through vegetation, and soil or engineered media prior to discharge via underdrain or overflow to the downstream conveyance system.</p>	

Fact Sheet Key	
1	Best Management Practice (BMP) Title
2	Categories, Standards, and Benefits
3	BMP Image
4	<p>Main Content; Categories Include:</p> <ul style="list-style-type: none"> <li>•Description</li> <li>•Design Adaptations for Project Goals</li> <li>•Recommended Siting Criteria</li> <li>•Recommended BMP Component Dimensions</li> <li>•Design Criteria and Considerations</li> <li>•Conceptual Design and Sizing Approach for                             <ul style="list-style-type: none"> <li>○ Site Design</li> <li>○ Storm Water Pollutant Control Only</li> <li>○ Integrated Storm Water Pollutant Control and Flow Control</li> </ul> </li> <li>•Maintenance Overview</li> <li>•Summary of Standard Inspection and Maintenance</li> </ul>



## E.1 Source Control BMP Requirements

### Worksheet E.1-1: Source Control BMP Requirements

**How to comply:** Projects shall comply with this requirement by implementing all source control BMPs listed in this section that are applicable to their project. Applicability shall be determined through consideration of the development project's features and anticipated pollutant sources. Appendix E.1 provides guidance for identifying source control BMPs applicable to a project. Checklist I.4 in Appendix I shall be used to document compliance with source control BMP requirements.

How to use this worksheet:

1. Review Column 1 and identify which of these potential sources of storm water pollutants apply to your site. Check each box that applies.
2. Review Column 2 and incorporate all of the corresponding applicable BMPs in your project site plan.
3. Review Columns 3 and 4 and incorporate all of the corresponding applicable permanent controls and operational BMPs in a table in your project-specific storm water management report. Describe your specific BMPs in an accompanying narrative, and explain any special conditions or situations that required omitting BMPs or substituting alternatives.

If These Sources Will Be on the Project Site ...	... Then Your SWQMP Shall Consider These Source Control BMPs		
1 Potential Sources of Runoff Pollutants	2 Permanent Controls—Show on Drawings	3 Permanent Controls—List in Table and Narrative	4 Operational BMPs—Include in Table and Narrative
<ul style="list-style-type: none"> <li><input type="checkbox"/> <b>SC-A.</b> Onsite storm drain inlets</li>   <li><input type="checkbox"/> Not Applicable</li> </ul>	<ul style="list-style-type: none"> <li><input type="checkbox"/> Locations of inlets.</li> </ul>	<ul style="list-style-type: none"> <li><input type="checkbox"/> Mark all inlets with the words “No Dumping! Flows to Creek” or similar.</li> </ul>	<ul style="list-style-type: none"> <li><input type="checkbox"/> Maintain and periodically repaint or replace inlet markings.</li> <li><input type="checkbox"/> Provide storm water pollution prevention information to new site owners, lessees, or operators.</li> <li><input type="checkbox"/> See applicable operational BMPs in Fact Sheet SC-44, “Drainage System Maintenance,” in the CASQA Stormwater Quality Handbooks at <a href="http://www.cabmphandbooks.com">www.cabmphandbooks.com</a>.</li> <li><input type="checkbox"/> Include the following in lease agreements: “Tenant shall not allow anyone to discharge anything to storm drains or to store or deposit materials so as to create a potential discharge to storm drains.”</li> </ul>

If These Sources Will Be on the Project Site ...	... Then Your SWQMP shall consider These Source Control BMPs		
1 Potential Sources of Runoff Pollutants	2 Permanent Controls—Show on Drawings	3 Permanent Controls—List in Table and Narrative	4 Operational BMPs—Include in Table and Narrative
<input type="checkbox"/> <b>SC-B.</b> Interior floor drains and elevator shaft sump pumps <input type="checkbox"/> Not Applicable		<input type="checkbox"/> State that interior floor drains and elevator shaft sump pumps will be plumbed to sanitary sewer.	<input type="checkbox"/> Inspect and maintain drains to prevent blockages and overflow.
<input type="checkbox"/> <b>SC-C.</b> Interior parking garages <input type="checkbox"/> Not Applicable		<input type="checkbox"/> State that parking garage floor drains will be plumbed to the sanitary sewer.	<input type="checkbox"/> Inspect and maintain drains to prevent blockages and overflow.
<input type="checkbox"/> <b>SC-D1.</b> Need for future indoor & structural pest control <input type="checkbox"/> Not Applicable		<input type="checkbox"/> Note building design features that discourage entry of pests.	<input type="checkbox"/> Provide Integrated Pest Management information to owners, lessees, and operators.

If These Sources Will Be on the Project Site ...	... Then Your SWQMP shall consider These Source Control BMPs		
1 Potential Sources of Runoff Pollutants	2 Permanent Controls—Show on Drawings	3 Permanent Controls—List in Table and Narrative	4 Operational BMPs—Include in Table and Narrative
<ul style="list-style-type: none"> <li><input type="checkbox"/> <b>SC-D2.</b> Landscape/Outdoor Pesticide Use</li> <li><input type="checkbox"/> Not Applicable</li> </ul>	<ul style="list-style-type: none"> <li><input type="checkbox"/> Show locations of existing trees or areas of shrubs and ground cover to be undisturbed and retained.</li> <li><input type="checkbox"/> Show self-retaining landscape areas, if any.</li> <li><input type="checkbox"/> Show storm water treatment facilities.</li> </ul>	<p>State that final landscape plans will accomplish all of the following.</p> <ul style="list-style-type: none"> <li><input type="checkbox"/> Preserve existing drought tolerant trees, shrubs, and ground cover to the maximum extent possible.</li> <li><input type="checkbox"/> Design landscaping to minimize irrigation and runoff, to promote surface infiltration where appropriate, and to minimize the use of fertilizers and pesticides that can contribute to storm water pollution.</li> <li><input type="checkbox"/> Where landscaped areas are used to retain or detain storm water, specify plants that are tolerant of periodic saturated soil conditions.</li> <li><input type="checkbox"/> Consider using pest-resistant plants, especially adjacent to hardscape.</li> <li><input type="checkbox"/> To ensure successful establishment, select plants appropriate to site soils, slopes, climate, sun, wind, rain, land use, air movement, ecological consistency, and plant interactions.</li> </ul>	<ul style="list-style-type: none"> <li><input type="checkbox"/> Maintain landscaping using minimum or no pesticides.</li> <li><input type="checkbox"/> See applicable operational BMPs in Fact Sheet SC-41, “Building and Grounds Maintenance,” in the CASQA Stormwater Quality Handbooks at <a href="http://www.cabmphandbooks.com">www.cabmphandbooks.com</a>.</li> <li><input type="checkbox"/> Provide IPM information to new owners, lessees and operators.</li> </ul>

If These Sources Will Be on the Project Site ...	... Then Your SWQMP shall consider These Source Control BMPs		
1 Potential Sources of Runoff Pollutants	2 Permanent Controls—Show on Drawings	3 Permanent Controls—List in Table and Narrative	4 Operational BMPs—Include in Table and Narrative
<ul style="list-style-type: none"> <li><input type="checkbox"/> <b>SC-E.</b> Pools, spas, ponds, decorative fountains, and other water features.</li> <li><input type="checkbox"/> Not Applicable</li> </ul>	<ul style="list-style-type: none"> <li><input type="checkbox"/> Show location of water feature and a sanitary sewer cleanout in an accessible area within 10 feet.</li> </ul>	<ul style="list-style-type: none"> <li><input type="checkbox"/> If the local municipality requires pools to be plumbed to the sanitary sewer, place a note on the plans and state in the narrative that this connection will be made according to local requirements.</li> </ul>	<ul style="list-style-type: none"> <li><input type="checkbox"/> See applicable operational BMPs in Fact Sheet SC-72, “Fountain and Pool Maintenance,” in the CASQA Stormwater Quality Handbooks at <a href="http://www.cabmphandbooks.com">www.cabmphandbooks.com</a>.</li> </ul>
<ul style="list-style-type: none"> <li><input type="checkbox"/> <b>SC-F.</b> Food service</li> <li><input type="checkbox"/> Not Applicable</li> </ul>	<ul style="list-style-type: none"> <li><input type="checkbox"/> For restaurants, grocery stores, and other food service operations, show location (indoors or in a covered area outdoors) of a floor sink or other area for cleaning floor mats, containers, and equipment.</li> <li><input type="checkbox"/> On the drawing, show a note that this drain will be connected to a grease interceptor before discharging to the sanitary sewer.</li> </ul>	<ul style="list-style-type: none"> <li><input type="checkbox"/> Describe the location and features of the designated cleaning area.</li> <li><input type="checkbox"/> Describe the items to be cleaned in this facility and how it has been sized to ensure that the largest items can be accommodated.</li> </ul>	

If These Sources Will Be on the Project Site ...	... Then Your SWQMP shall consider These Source Control BMPs		
1 Potential Sources of Runoff Pollutants	2 Permanent Controls—Show on Drawings	3 Permanent Controls—List in Table and Narrative	4 Operational BMPs—Include in Table and Narrative
<ul style="list-style-type: none"> <li><input type="checkbox"/> SC-G. Refuse areas</li> <li><input type="checkbox"/> Not Applicable</li> </ul>	<ul style="list-style-type: none"> <li><input type="checkbox"/> Show where site refuse and recycled materials will be handled and stored for pickup. See local municipal requirements for sizes and other details of refuse areas.</li> <li><input type="checkbox"/> If dumpsters or other receptacles are outdoors, show how the designated area will be covered, graded, and paved to prevent run-on and show locations of berms to prevent runoff from the area. Also show how the designated area will be protected from wind dispersal.</li> <li><input type="checkbox"/> Any drains from dumpsters, compactors, and tallow bin areas shall be connected to a grease removal device before discharge to sanitary sewer.</li> </ul>	<ul style="list-style-type: none"> <li><input type="checkbox"/> State how site refuse will be handled and provide supporting detail to what is shown on plans.</li> <li><input type="checkbox"/> State that signs will be posted on or near dumpsters with the words “Do not dump hazardous materials here” or similar.</li> </ul>	<ul style="list-style-type: none"> <li><input type="checkbox"/> State how the following will be implemented: Provide adequate number of receptacles. Inspect receptacles regularly; repair or replace leaky receptacles. Keep receptacles covered. Prohibit/prevent dumping of liquid or hazardous wastes. Post “no hazardous materials” signs. Inspect and pick up litter daily and clean up spills immediately. Keep spill control materials available on-site. See Fact Sheet SC-34, “Waste Handling and Disposal” in the CASQA Stormwater Quality Handbooks at <a href="http://www.cabmphandbooks.com">www.cabmphandbooks.com</a>.</li> </ul>

If These Sources Will Be on the Project Site ...	... Then Your SWQMP shall consider These Source Control BMPs		
1 Potential Sources of Runoff Pollutants	2 Permanent Controls—Show on Drawings	3 Permanent Controls—List in Table and Narrative	4 Operational BMPs—Include in Table and Narrative Table and Narrative
<input type="checkbox"/> <b>SC-H.</b> Industrial processes. <input type="checkbox"/> Not Applicable	<input type="checkbox"/> Show process area.	<input type="checkbox"/> If industrial processes are to be located onsite, state: “All process activities to be performed indoors. No processes to drain to exterior or to storm drain system.”	<input type="checkbox"/> See Fact Sheet SC-10, “Non-Stormwater Discharges” in the CASQA Stormwater Quality Handbooks at <a href="http://www.cabmphandbooks.com">www.cabmphandbooks.com</a> .
<input type="checkbox"/> <b>SC-I.</b> Outdoor storage of equipment or materials. (See rows J and K for source control measures for vehicle cleaning, repair, and maintenance.) <input type="checkbox"/> Not Applicable	<input type="checkbox"/> Show any outdoor storage areas, including how materials will be covered. Show how areas will be graded and bermed to prevent run-on or runoff from area and protected from wind dispersal. <input type="checkbox"/> Storage of non-hazardous liquids shall be covered by a roof and/or drain to the sanitary sewer system, and be contained by berms, dikes, liners, or vaults. <input type="checkbox"/> Storage of hazardous materials and wastes must be in compliance with the local hazardous materials ordinance and a Hazardous Materials Management Plan for the site.	<input type="checkbox"/> Include a detailed description of materials to be stored, storage areas, and structural features to prevent pollutants from entering storm drains. Where appropriate, reference documentation of compliance with the requirements of local Hazardous Materials Programs for: <ul style="list-style-type: none"> <li>▪ Hazardous Waste Generation</li> <li>▪ Hazardous Materials Release Response and Inventory</li> <li>▪ California Accidental Release Prevention Program</li> <li>▪ Aboveground Storage Tank</li> <li>▪ Uniform Fire Code Article 80 Section 103(b) &amp; (c) 1991</li> <li>▪ Underground Storage Tank</li> </ul>	<input type="checkbox"/> See the Fact Sheets SC-31, “Outdoor Liquid Container Storage” and SC-33, “Outdoor Storage of Raw Materials” in the CASQA Stormwater Quality Handbooks at <a href="http://www.cabmphandbooks.com">www.cabmphandbooks.com</a> .

If These Sources Will Be on the Project Site ...	... Then Your SWQMP shall consider These Source Control BMPs		
1 Potential Sources of Runoff Pollutants	2 Permanent Controls—Show on Drawings	3 Permanent Controls—List in Table and Narrative	4 Operational BMPs—Include in Table and Narrative
<ul style="list-style-type: none"> <li><input type="checkbox"/> SC-J. Vehicle and Equipment Cleaning</li> <li><input type="checkbox"/> Not Applicable</li> </ul>	<ul style="list-style-type: none"> <li><input type="checkbox"/> Show on drawings as appropriate:               <ol style="list-style-type: none"> <li>(1) Commercial/industrial facilities having vehicle /equipment cleaning needs shall either provide a covered, bermed area for washing activities or discourage vehicle/equipment washing by removing hose bibs and installing signs prohibiting such uses.</li> <li>(2) Multi-dwelling complexes shall have a paved, bermed, and covered car wash area (unless car washing is prohibited onsite and hoses are provided with an automatic shut-off to discourage such use).</li> <li>(3) Washing areas for cars, vehicles, and equipment shall be paved, designed to prevent run-on to or runoff from the area, and plumbed to drain to the sanitary sewer.</li> <li>(4) Commercial car wash facilities shall be designed such that no runoff from the facility is discharged to the storm drain system. Wastewater from the facility shall discharge to the sanitary sewer, or a wastewater reclamation system shall be installed.</li> </ol> </li> </ul>	<ul style="list-style-type: none"> <li><input type="checkbox"/> If a car wash area is not provided, describe measures taken to discourage onsite car washing and explain how these will be enforced.</li> </ul>	<p>Describe operational measures to implement the following (if applicable):</p> <ul style="list-style-type: none"> <li><input type="checkbox"/> Washwater from vehicle and equipment washing operations shall not be discharged to the storm drain system.</li> <li><input type="checkbox"/> Car dealerships and similar may rinse cars with water only.</li> <li><input type="checkbox"/> See Fact Sheet SC-21, “Vehicle and Equipment Cleaning,” in the CASQA Stormwater Quality Handbooks at <a href="http://www.cabmphandbooks.com">www.cabmphandbooks.com</a></li> </ul>



If These Sources Will Be on the Project Site ...	... Then Your SWQMP shall consider These Source Control BMPs		
1 Potential Sources of Runoff Pollutants	2 Permanent Controls—Show on Drawings	3 Permanent Controls—List in Table and Narrative	4 Operational BMPs—Include in Table and Narrative
<ul style="list-style-type: none"> <li><input type="checkbox"/> <b>SC-K.</b> Vehicle/Equipment Repair and Maintenance</li> <li><input type="checkbox"/> Not Applicable</li> </ul>	<ul style="list-style-type: none"> <li><input type="checkbox"/> Accommodate all vehicle equipment repair and maintenance indoors. Or designate an outdoor work area and design the area to protect from rainfall, run-on runoff, and wind dispersal.</li> <li><input type="checkbox"/> Show secondary containment for exterior work areas where motor oil, brake fluid, gasoline, diesel fuel, radiator fluid, acid-containing batteries or other hazardous materials or hazardous wastes are used or stored. Drains shall not be installed within the secondary containment areas.</li> <li><input type="checkbox"/> Add a note on the plans that states either (1) there are no floor drains, or (2) floor drains are connected to wastewater pretreatment systems prior to discharge to the sanitary sewer and an industrial waste discharge permit will be obtained.</li> </ul>	<ul style="list-style-type: none"> <li><input type="checkbox"/> State that no vehicle repair or maintenance will be done outdoors, or else describe the required features of the outdoor work area.</li> <li><input type="checkbox"/> State that there are no floor drains or if there are floor drains, note the agency from which an industrial waste discharge permit will be obtained and that the design meets that agency's requirements.</li> <li><input type="checkbox"/> State that there are no tanks, containers or sinks to be used for parts cleaning or rinsing or, if there are, note the agency from which an industrial waste discharge permit will be obtained and that the design meets that agency's requirements.</li> </ul>	<p>In the report, note that all of the following restrictions apply to use the site:</p> <ul style="list-style-type: none"> <li><input type="checkbox"/> No person shall dispose of, nor permit the disposal, directly or indirectly of vehicle fluids, hazardous materials, or rinsewater from parts cleaning into storm drains.</li> <li><input type="checkbox"/> No vehicle fluid removal shall be performed outside a building, nor on asphalt or ground surfaces, whether inside or outside a building, except in such a manner as to ensure that any spilled fluid will be in an area of secondary containment. Leaking vehicle fluids shall be contained or drained from the vehicle immediately.</li> <li><input type="checkbox"/> No person shall leave unattended drip parts or other open containers containing vehicle fluid, unless such containers are in use or in an area of secondary containment.</li> </ul>

If These Sources Will Be on the Project Site ...	... Then Your SWQMP shall consider These Source Control BMPs		
1 Potential Sources of Runoff Pollutants	2 Permanent Controls—Show on Drawings	3 Permanent Controls—List in Table and Narrative	4 Operational BMPs—Include in Table and Narrative
<ul style="list-style-type: none"> <li><input type="checkbox"/> SC-L. Fuel Dispensing Areas</li> <li><input type="checkbox"/> Not Applicable</li> </ul>	<ul style="list-style-type: none"> <li><input type="checkbox"/> Fueling areas<sup>1</sup> shall have impermeable floors (i.e., portland cement concrete or equivalent smooth impervious surface) that are (1) graded at the minimum slope necessary to prevent ponding; and (2) separated from the rest of the site by a grade break that prevents run-on of storm water to the MEP.</li> <li><input type="checkbox"/> Fueling areas shall be covered by a canopy that extends a minimum of ten feet in each direction from each pump. [Alternative: The fueling area must be covered and the cover’s minimum dimensions must be equal to or greater than the area within the grade break or fuel dispensing area<sup>1</sup>.] The canopy [or cover] shall not drain onto the fueling area.</li> </ul>		<ul style="list-style-type: none"> <li><input type="checkbox"/> The property owner shall dry sweep the fueling area routinely.</li> <li><input type="checkbox"/> See the Business Guide Sheet, “Automotive Service—Service Stations” in the CASQA Stormwater Quality Handbooks at <a href="http://www.cabmphandbooks.com">www.cabmphandbooks.com</a>.</li> </ul>

1. The fueling area shall be defined as the area extending a minimum of 6.5 feet from the corner of each fuel dispenser or the length at which the hose and nozzle assembly may be operated plus a minimum of one foot, whichever is greater.

If These Sources Will Be on the Project Site ...	... Then Your SWQMP shall consider These Source Control BMPs		
1 Potential Sources of Runoff Pollutants	2 Permanent Controls—Show on Drawings	3 Permanent Controls—List in Table and Narrative	4 Operational BMPs—Include in Table and Narrative
<ul style="list-style-type: none"> <li><input type="checkbox"/> SC-M. Loading Docks</li> <li><input type="checkbox"/> Not Applicable</li> </ul>	<ul style="list-style-type: none"> <li><input type="checkbox"/> Show a preliminary design for the loading dock area, including roofing and drainage. Loading docks shall be covered and/or graded to minimize run-on to and runoff from the loading area. Roof downspouts shall be positioned to direct storm water away from the loading area. Water from loading dock areas should be drained to the sanitary sewer where feasible. Direct connections to storm drains from depressed loading docks are prohibited.</li> <li><input type="checkbox"/> Loading dock areas draining directly to the sanitary sewer shall be equipped with a spill control valve or equivalent device, which shall be kept closed during periods of operation.</li> <li><input type="checkbox"/> Provide a roof overhang over the loading area or install door skirts (cowling) at each bay that enclose the end of the trailer.</li> </ul>		<ul style="list-style-type: none"> <li><input type="checkbox"/> Move loaded and unloaded items indoors as soon as possible.</li> <li><input type="checkbox"/> See Fact Sheet SC-30, “Outdoor Loading and Unloading,” in the CASQA Stormwater Quality Handbooks at <a href="http://www.cabmphandbooks.com">www.cabmphandbooks.com</a>.</li> </ul>

If These Sources Will Be on the Project Site ...	... Then Your SWQMP shall consider These Source Control BMPs		
1 Potential Sources of Runoff Pollutants	2 Permanent Controls—Show on Drawings	3 Permanent Controls—List in Table and Narrative	4 Operational BMPs—Include in Table and Narrative
<ul style="list-style-type: none"> <li><input type="checkbox"/> <b>SC-N.</b> Fire Sprinkler Test Water</li> <li><input type="checkbox"/> Not Applicable</li> </ul>		<ul style="list-style-type: none"> <li><input type="checkbox"/> Provide a means to drain fire sprinkler test water to the sanitary sewer.</li> </ul>	<ul style="list-style-type: none"> <li><input type="checkbox"/> See the note in Fact Sheet SC-41, “Building and Grounds Maintenance,” in the CASQA Stormwater Quality Handbooks at <a href="http://www.cabmphandbooks.com">www.cabmphandbooks.com</a>.</li> </ul>
<ul style="list-style-type: none"> <li><input type="checkbox"/> <b>SC-O.</b> Miscellaneous Drain or Wash Water                             <ul style="list-style-type: none"> <li><input type="checkbox"/> Boiler drain lines</li> <li><input type="checkbox"/> Condensate drain lines</li> <li><input type="checkbox"/> Rooftop equipment</li> <li><input type="checkbox"/> Drainage sumps</li> <li><input type="checkbox"/> Roofing, gutters, and trim</li> </ul> </li> <li><input type="checkbox"/> Not Applicable</li> </ul>		<ul style="list-style-type: none"> <li><input type="checkbox"/> Boiler drain lines shall be directly or indirectly connected to the sanitary sewer system and may not discharge to the storm drain system.</li> <li><input type="checkbox"/> Condensate drain lines may discharge to landscaped areas if the flow is small enough that runoff will not occur. Condensate drain lines may not discharge to the storm drain system.</li> <li><input type="checkbox"/> Rooftop mounted equipment with potential to produce pollutants shall be roofed and/or have secondary containment.</li> <li><input type="checkbox"/> Any drainage sumps onsite shall feature a sediment sump to reduce the quantity of sediment in pumped water.</li> <li><input type="checkbox"/> Avoid roofing, gutters, and trim made of copper or other unprotected metals that may leach into runoff.</li> </ul>	

If These Sources Will Be on the Project Site ...	... Then Your SWQMP shall consider These Source Control BMPs		
1 Potential Sources of Runoff Pollutants	2 Permanent Controls—Show on Drawings	3 Permanent Controls—List in Table and Narrative	4 Operational BMPs—Include in Table and Narrative
<input type="checkbox"/> <b>SC-P.</b> Plazas, sidewalks, and parking lots. <input type="checkbox"/> Not Applicable			<input type="checkbox"/> Plazas, sidewalks, and parking lots shall be swept regularly to prevent the accumulation of litter and debris.  Debris from pressure washing shall be collected to prevent entry into the storm drain system. Washwater containing any cleaning agent or degreaser shall be collected and discharged to the sanitary sewer and not discharged to a storm drain.

## E.2 SC-Q Large Trash Generating Facilities



---

**MS4 Permit Category**

---

Source Control

---

**BMP Manual Category**

---

Source Control

---

**Applicable Performance Standard**

---

Source Control

---

**Primary Benefits**

---

Source Control

**Description**

Storm water runoff from areas where trash is stored or disposed of can be polluted. In addition, loose trash and debris can be easily transported by water or wind to nearby storm drain inlets, channels, and/or creeks. Trash generating facilities that generate large amounts of trash require special attention to protect trash storage areas from rainfall, run-on, runoff, and wind dispersal. Large trash generating, or trash build-up areas, include but are not limited to restaurants, supermarkets, “big box” retail stores serving food, and pet stores. The City Engineer may designate additional facilities if they are likely to generate or accumulate large quantities of trash.

Example isometric view and plan view of an allowable trash enclosure facility is presented below. The project applicant may be allowed to use an alternative trash enclosure design that might be more appropriate for a project site if the alternative design is approved by the City Engineer.

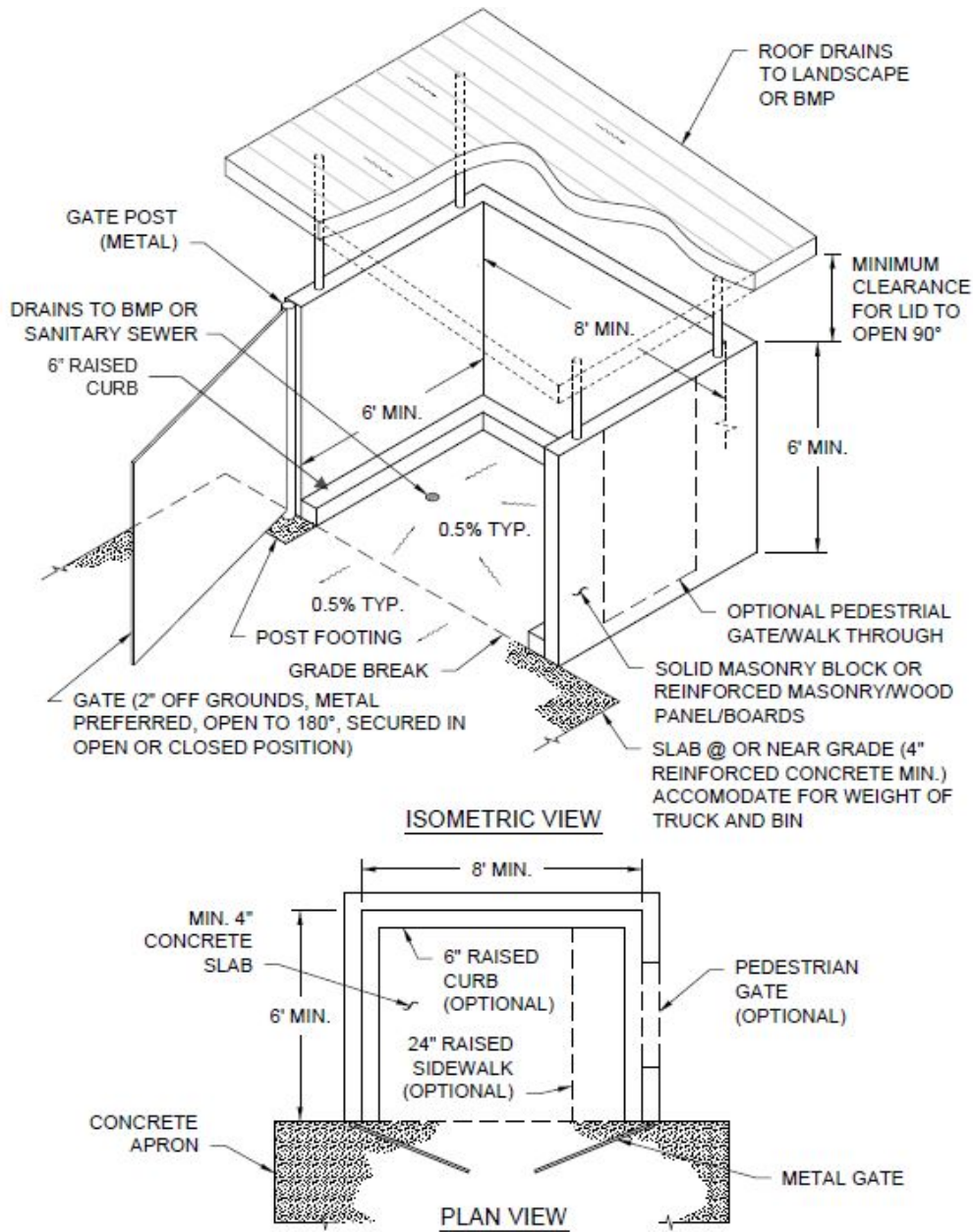

Typical Isometric and Plan View of a Trash Enclosure BMP

**Design Adaptations for Project Goals**

Source control BMPs reduce the amount of pollutants that are generated. This fact sheet contains details on the additional measures required to prevent or reduce pollutants in storm water runoff associated with trash storage and handling for large trash generating facilities. The requirements

presented here are in addition to the requirements of SC-5 which requires all development projects to protect trash storage areas from rainfall, run-on, runoff, and wind dispersal:

- **Areas where trash containers are stored must be enclosed on four sides to prevent off-site transport of trash.** Four-sided trash enclosures typically consist of three walled sides and one gated side. Trash enclosures limit the potential for trash to pollute storm water runoff by limiting mobilization mechanisms (runoff, run-on, and wind dispersal).
- **Trash enclosures must be covered to minimize direct precipitation and prevent rainfall from entering enclosures.** Structural overhead covers are required as container lids are often left open.
- **Enclosures must be hydraulically isolated from surrounding areas.** Slabs shall be sloped such that any leaked materials will be contained within the enclosure. Drains must be provided that capture and direct potential leaks to the sanitary sewer or appropriate BMPs. Divert runoff from surrounding areas away from the enclosure to prevent contamination and dispersion of collected materials.
- **Owner must provide BMP storm water training to employees.** Employee participation is required to ensure that enclosures are properly maintained and kept clean.

**Design Criteria and Considerations**

All trash shall be stored in weather-protected receptacles/bins and recyclable materials shall be protected against adverse weather conditions, which might render the collected materials unmarketable. Trash enclosure dimensions will vary based on projected usage and the following information is offered as an aid in planning new projects. Businesses that use dumpsters must design the enclosure to accommodate three-yard. The tenants may use any dumpster size that is appropriate for their needs, but the enclosure must be able to accommodate different tenants with varying waste production, including any recycling requirements. The location and design of the enclosure will require review and approval by the Planning Division, and also might require review by the City’s Design Review Board (DRB). Any storm water requirements will need to be coordinated and approved by the Engineering Division. Building permits may be required.

The following recommendations for typical bin sizes are adopted from the City of Escondido trash enclosure guidelines. The following bin/container measurements are approximate (add 8” to width for side pockets):

**Typical Trash Bin Sizes**

Size	Width	Depth	Height (front)	Height (back)
1 ½ cubic yard	72” bin, 81” plus lid	34”	30”	51”
3 cubic yard	72” bin, 81” plus lid	43”	42”	70”
4 cubic yard	72” bin, 81” plus lid	56”	72”	72”

Filled weight should not exceed 1,000 pounds.



## E.2: SC-Q Large Trash Generating Facilities

1. Enclosures shall be structurally strong and constructed of solid masonry block or reinforced masonry with a decorative finish to be compatible with the architecture of the building(s) and landscaping (i.e., split face, slump stone, stucco exterior, etc.).
2. The enclosure should be constructed to the following minimum inside dimensions to accommodate three cubic-yard dumpsters (larger enclosures may be necessary to accommodate additional trash bins, recycling bins, and accessibility):

No. of Bins	Loading	Width	Depth	Height
One	Front	8'	6'	6'
One	Side	7.5'	8'	6'
Two	Front	16'	6'	6'
Two	Side	8'	16'	6'

3. The slab should be near or at the same level or grade as the street or parking area to facilitate the rolling of bins for loading and unloading. The slab also should be designed/sloped to keep storm water drainage out of the enclosure area (typically 0.5% slope). Wheeled bins can be moved by jarring or pushing, and a sloped slab can cause them to roll, resulting in possible damage to enclosure walls, doors, vehicles, or injury to people. Therefore, the slab should not be designed with excessively steep slopes and the bins should be appropriately secured within.
4. Enclosures shall satisfy the Location Criteria and other provisions of the City of Escondido Trash Enclosure Guidelines available at: <https://www.escondido.org/miscellaneous-resources.aspx>.

## E.3 SC-R Animal Facilities



---

### MS4 Permit Category

---

Source Control

---

### BMP Manual Category

---

Source Control

---

### Applicable Performance Standard

---

Source Control

---

### Primary Benefits

---

Source Control

### Description

Animal facilities have an elevated potential for bacterial loading. If animal fecal material comes into contact with storm water, the storm water can become polluted. Animal facilities include but are not limited to animal shelters, dog daycare centers, veterinary clinics, groomers, pet care stores, and breeding, boarding, and training facilities. The City Engineer may designate additional facilities where animal fecal material is likely to be found.

### Design Adaptations for Project Goals

**Source control BMPs reduce the amount of pollutants that are generated.** This fact sheet contains details on the additional measures required to prevent or reduce pollutants in storm water runoff associated with animal facilities. The requirements presented here are in addition to the source control requirements for all projects:

- **Dry weather runoff must be controlled.** Dry weather runoff from hosed off areas as part of animal facility operations must not drain to the MS4. Dry weather flows should be retained on-site through implementation of BMPs or collected and discharged to the sanitary sewer.
- **Outdoor activity areas must be identified on site plans.** Plan reviewers must be able to ensure that runoff from these areas is either diverted to the sanitary sewer or directed to appropriate treatment BMPs. On-site inspection of facilities, grading, and drainage may be required.
- **Trash enclosures within animal facilities must be covered to minimize direct precipitation and prevent rainfall from entering enclosures.** Structural overhead covers are required as container lids are often left open.

## E.4 SC-S Plant Nurseries and Garden Centers



---

**MS4 Permit Category**

---

Source Control

---

**BMP Manual Category**

---

Source Control

---

**Applicable Performance Standard**

---

Source Control

---

**Primary Benefits**

---

Source Control

**Description**

Storm water runoff from plant nurseries and garden centers has an elevated risk of being polluted by organics, nutrients, and/or pesticides. Nurseries and garden centers require special attention to protect against these elevated risks. Plant nurseries and garden centers include but are not limited to commercial facilities that grow, distribute, sell, or store plants and plant material. The City Engineer may designate additional facilities if they are likely to be a source of organics, nutrients or pesticides.

**Design Adaptations for Project Goals**

**Source control BMPs reduce the amount of pollutants that are generated.** This fact sheet contains details on the additional measures required to prevent or reduce pollutants in storm water runoff associated with plant nurseries or garden center facilities. The requirements presented here are in addition to the requirements of SC-1 through SC-5 which require all development projects to avoid and reduce pollutants in storm water runoff:

- **Owner must provide BMP storm water training to appropriate employees.** Employee participation is required to ensure that source controls are properly maintained and behavioral BMPs are followed.
- **Eliminate overwatering and overspraying of plants.** Overwatering and overspraying of plants increases dry weather flows and pollutant loading, and wastes water. Delivery systems and schedules should account for different plant types and containers.
- **Discharges from outdoor watering areas must be controlled.** Regular runoff from outdoor watering can contribute un-authorized dry weather flows to the MS4 (e.g., runoff from watering the plants at garden centers). Runoff water is also likely to be polluted by potting soil mixes and plants that contain fertilizers and/or pesticides. So, regular runoff should be treated and/or retained on-site through BMPs or discharged to the sanitary sewer.

## E.5 SC-T Automotive Facilities



---

### MS4 Permit Category

---

Source Control

---

### BMP Manual Category

---

Source Control

---

### Applicable Performance Standard

---

Source Control

---

### Primary Benefits

---

Source Control

---

### Description

Storm water runoff from automotive facilities can pollute storm water runoff with oils and grease, metals, and other pollutants. Pollutants sources can include maintenance and repair activities, outside storage areas, liquid material storage, and others. Automotive facilities require additional measures because of the potential impact of pollutants. Automotive facilities include but are not limited to facilities that perform maintenance or repair of vehicles, vehicle washing facilities, and retail gasoline outlets. The City Engineer may designate additional facilities if they are likely sources of storm water pollutants.

---

### Design Adaptations for Project Goals

**Source control BMPs reduce the amount of pollutants that are generated.** This fact sheet contains details on the additional measures required to prevent or reduce pollutants in storm water runoff associated with automotive facilities. The requirements presented here are in addition to the requirements of SC-1 through SC-5 which require all development projects avoid and reduce pollutants in storm water runoff:

- **Auto repair, maintenance activities, fueling, and vehicle washing must be conducted in covered areas.** Activity areas must be protected from precipitation by permanent canopy or roof structures. Covers 10 feet high or less should have a minimum overhang of 3 feet on each side, covers higher than 10 feet should have a minimum overhang of 5 feet on each side. Overhang should be measured from the perimeter of the hydraulically isolated activity area.
- **Hydraulically isolate activity areas.** Activity areas should be protected from run-on that can mobilize pollutants and pollute uncontaminated storm water through the use of grading, berms, or drains. Direct drainage from the hydraulically isolated area to an approved sanitary sewer or a BMP.

- **Pave activity areas with hydraulic concrete or appropriately sealed asphalt cement.** Unpaved activity areas could contaminate ground water. So all activity area, including area for fueling vehicles or equipment shall be paved with hydraulic concrete. If the area is already paved with asphalt, apply an asphalt sealant to the pavement surface. Maintain the paved surface to prevent gaps and cracks.
- **Provide sedimentation manhole with outlet.** Automotive facilities discharging to the sanitary sewer must follow standards set by the City Industrial Wastewater Control Program for the outlet design. See Appendix S: Sump/Clarifier Maintenance Standards found here for the outlet design:
  - <http://www.sandiego.gov/mwwd/environment/iwcp/other.shtml>
- **Provide appropriate oil controls.** All equipment and vehicle washing activity areas should include oil controls. On-site wash recycling systems may be used for oil control if they meet applicable effluent discharge limits for the sanitary sewer.
- **Identify auto-related usage areas on site plans and describe activities and drainage.** Plan checkers must be satisfied that grading and drainage will prevent contact between pollutants and storm water. Drains within the facilities must be connected to the sanitary sewer or a BMP. Verification may be required.
- Owner must provide BMP storm water training to employees. Employee participation is required to ensure that activity areas are properly maintained and kept clean.

## E.6 SD-A Tree Well



*Tree Well (Source: County of San Diego LID Manual – EOA, Inc.)*

---

**MS4 Permit Category**

---

Site Design

---

**Manual Category**

---

Site Design

---

**Applicable Performance Standard**

---

Site Design

---

**Primary Benefits**

---

Volume Reduction

### **Description**

Trees planted to intercept rainfall and runoff can be used as storm water management measures that provide additional benefits beyond those typically associated with trees, including energy conservation, air quality improvement, and aesthetic enhancement. Typical storm water management benefits associated with trees include:

- **Interception of rainfall** – tree surfaces (roots, foliage, bark, and branches) intercept, evaporate, store, or convey precipitation to the soil before it reaches surrounding impervious surfaces
- **Reduced erosion** – trees protect denuded area by intercepting or reducing the velocity of rain drops as they fall through the tree canopy
- **Increased infiltration** – soil conditions created by roots and fallen leaves promote infiltration
- **Treatment of storm water** – trees provide treatment through uptake of nutrients and other storm water pollutants (phytoremediation) and support of other biological processes that break down pollutants

Typical tree well system components include:

- Trees of the appropriate species for site conditions and constraints
- Available growing space based on tree species, soil type, water availability, surrounding land uses, and project goals
- Optional suspended pavement design to provide structural support for adjacent pavement without requiring compaction of underlying layers
- Optional root barrier devices as needed; a root barrier is a device installed in the ground, between a tree and the sidewalk, intended to guide roots down and away from the sidewalk in order to prevent sidewalk lifting from tree roots.
- Optional tree grates; to be considered to maximize available space for pedestrian circulation and to protect tree roots from compaction related to pedestrian circulation; tree grates are typically made up of porous material that will allow the runoff to soak through.
- Optional shallow surface depression for ponding of excess runoff
- Optional planter box drain

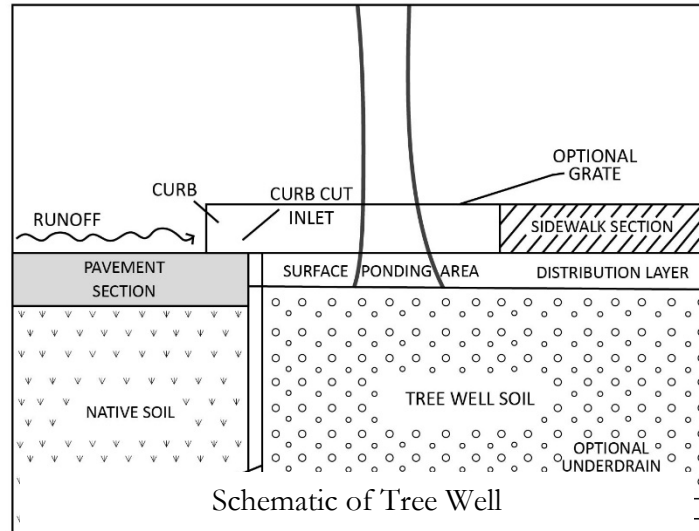

### Design Adaptations for Project Goals

**Site design BMP to provide incidental treatment.** Tree wells primarily functions as site design BMPs for incidental treatment. Benefits from tree wells are accounted for by adjustment factors presented in Appendix B.2. This credit can apply to other landscaping trees as well (that meet the same criteria). Trees as a site design BMP are only credited up to 0.25 times the DCV from the project footprint (with a maximum single tree credit volume of 400 ft<sup>3</sup>). Copermittees may deviate from the criteria by developing additional sizing guidance and design requirements.

**Storm water pollutant control BMP to provide treatment.** Applicants are allowed to design trees as a pollutant control BMP and obtain credit greater than 0.25 times the DCV from the project footprint (or a credit greater than 400 ft<sup>3</sup> from a single tree). For this option to be approved by the City Engineer, applicant is required to do infiltration feasibility screening (Appendix C and D) and provide calculations supporting the amount of credit claimed from implementing trees within the project footprint. The City Engineer has the discretion to request additional analysis before approving credits greater than 0.25 times the DCV from the project footprint (or a credit greater than 400 ft<sup>3</sup> from a single tree).

**Design Criteria and Considerations**

Tree wells must meet the following design criteria and considerations. Deviations from the below criteria may be approved at the discretion of the City Engineer if it is determined to be appropriate:

<i>Siting and Design</i>	<i>Intent/Rationale</i>														
<p><input type="checkbox"/> <b>Tree species</b> is appropriately chosen for the development (private or public). For public rights-of-ways, local planning guidelines and zoning provisions for the permissible species and placement of trees are consulted. A list of trees appropriate for site design that can be used by all county municipalities are provided in Appendix E.26</p>	<p>Proper tree placement and species selection minimizes problems such as pavement damage by surface roots and poor growth.</p>														
<p><b>Location of trees</b> planted along public streets follows local requirements and guidelines. Vehicle and pedestrian line of sight are considered in tree selection and placement.</p> <p>Unless exemption is granted by the City Engineer the following minimum tree separation distance is followed</p> <table border="1" style="margin-left: 40px;"> <thead> <tr> <th style="text-align: center;">Improvement</th> <th style="text-align: center;">Minimum distance to Tree Well</th> </tr> </thead> <tbody> <tr> <td>Traffic Signal, Stop sign</td> <td style="text-align: center;">20 feet</td> </tr> <tr> <td>Underground Utility lines (except sewer)</td> <td style="text-align: center;">5 feet</td> </tr> <tr> <td>Sewer Lines</td> <td style="text-align: center;">10 feet</td> </tr> <tr> <td>Above ground utility structures (Transformers, Hydrants, Utility poles, etc.)</td> <td style="text-align: center;">10 feet</td> </tr> <tr> <td>Driveways</td> <td style="text-align: center;">10 feet</td> </tr> <tr> <td>Intersections (intersecting curb lines of two streets)</td> <td style="text-align: center;">25 feet</td> </tr> </tbody> </table>	Improvement	Minimum distance to Tree Well	Traffic Signal, Stop sign	20 feet	Underground Utility lines (except sewer)	5 feet	Sewer Lines	10 feet	Above ground utility structures (Transformers, Hydrants, Utility poles, etc.)	10 feet	Driveways	10 feet	Intersections (intersecting curb lines of two streets)	25 feet	<p>Roadway safety for both vehicular and pedestrian traffic is a key consideration for placement along public streets.</p>
Improvement	Minimum distance to Tree Well														
Traffic Signal, Stop sign	20 feet														
Underground Utility lines (except sewer)	5 feet														
Sewer Lines	10 feet														
Above ground utility structures (Transformers, Hydrants, Utility poles, etc.)	10 feet														
Driveways	10 feet														
Intersections (intersecting curb lines of two streets)	25 feet														
<p><input type="checkbox"/> <b>Underground utilities and overhead wires</b> are considered in the design and avoided or circumvented. Underground utilities are routed</p>	<p>Tree growth can damage utilities and overhead wires resulting in service interruptions. Protecting utilities routed</p>														



<i>Siting and Design</i>	<i>Intent/Rationale</i>
<p>around or through the planter in suspended pavement applications. All underground utilities are protected from water and root penetration.</p>	<p>through the planter prevents damage and service interruptions.</p>
<p><input type="checkbox"/> <b>Suspended pavement</b> design was developed where appropriate to minimize soil compaction and improve infiltration and filtration capabilities.</p> <p>Suspended pavement was constructed with an approved structural cell.</p>	<p>Suspended pavement designs provide structural support without compaction of the underlying layers, thereby promoting tree growth.</p> <p>Recommended structural cells include poured in place concrete columns, Silva Cells manufactured by Deepproot Green Infrastructures and Stratacell and Stratavault systems manufactured by Citygreen Systems.</p>
<p><input type="checkbox"/> A minimum soil volume of 2 cubic feet per square foot of canopy projection volume is provided for each tree. Canopy projection area is the ground area beneath the tree, measured at the drip line.</p>	<p>The minimum soil volume ensures that there is adequate storage volume to allow for unrestricted evapotranspiration.</p> <p>A lower amount of soil volume may be allowed at the discretion of the City Engineer if certified by a landscape architect or agronomist. The retention credit from the tree is directly proportional to the soil volume provided for the tree.</p>
<p><input type="checkbox"/> DCV from the tributary area draining to the tree is equal to or greater than the tree credit volume</p>	<p>The minimum tributary area ensures that the tree receives enough runoff to fully utilize the infiltration and evapotranspiration potential provided. In cases where the minimum tributary area is not provided, the tree credit volume must be reduced proportionately to the actual tributary area.</p>
<p><input type="checkbox"/> Inlet opening to the tree that is at least 18 inches wide.</p>	<p>Design requirement to ensure that the runoff from the tributary area is not bypassed.</p>

<i>Siting and Design</i>	<i>Intent/Rationale</i>
<p>A minimum 2 inch drop in grade from the inlet to the finish grade of the tree.</p> <p>Grated inlets are allowed for pedestrian circulation. Grates need to be ADA compliant and have sufficient slip resistance.</p>	<p>Different inlet openings and drops in grade may be allowed at the discretion of the City Engineer if calculations are shown that the diversion flow rate (Appendix B.1.2) from the tributary area can be conveyed to the tree. In cases where the inlet capacity is limiting the amount of runoff draining to the tree, the tree credit volume must be reduced proportionately.</p>

### **Conceptual Design and Sizing Approach for Site Design**

1. Determine the areas where tree wells can be used in the site design to achieve incidental treatment. Tree wells reduce runoff volumes from the site. Refer to Appendix B.2. Document the proposed tree locations in the SWQMP.
2. When trees are proposed as a storm water pollutant control BMP, applicant must complete feasibility analysis in Appendix C and D and submit detailed calculations for the DCV treated by trees. Document the proposed tree locations, feasibility analysis and sizing calculations in the SWQMP. The following calculations should be performed and the smallest of the three should be used as the volume treated by trees:
  - a. Delineate the DMA (tributary area) to the tree and calculate the associated DCV.
  - b. Calculate the required diversion flow rate using Appendix B.1.2 and size the inlet required to convey this flow rate to the tree. If the proposed inlet cannot convey the diversion flow rate for the entire tributary area, then the DCV that enters the tree should be proportionally reduced.
    - i. For example, 0.5 acre drains to the tree and the associated DCV is 820 ft<sup>3</sup>. The required diversion flow rate is 0.10 ft<sup>3</sup>/s, but only an inlet that can divert 0.05 ft<sup>3</sup>/s could be installed.
    - ii. Then the effective DCV draining to the tree = 820 ft<sup>3</sup> \* (0.05/0.10) = 420 ft<sup>3</sup>
  - c. Estimate the amount of storm water treated by the tree by summing the following:
    - i. Evapotranspiration credit of 0.1 \* amount of soil volume installed; and
    - ii. Infiltration credit calculated using sizing procedures in Appendix B.4.

---

**Maintenance Overview**

---

**Normal Expected Maintenance.** Tree health shall be maintained as part of normal landscape maintenance. Additionally, ensure that storm water runoff can be conveyed into the tree well as designed. That is, the opening that allows storm water runoff to flow into the tree well (e.g., a curb opening, tree grate, or surface depression) shall not be blocked, filled, re-graded, or otherwise changed in a manner that prevents storm water from draining into the tree well. A summary table of standard inspection and maintenance indicators is provided within this Fact Sheet.

**Non-Standard Maintenance or BMP Failure.** Trees wells are site design BMPs that normally do not require maintenance actions beyond routine landscape maintenance. The normal expected maintenance described above ensures the BMP functionality. If changes have been made to the tree well entrance / opening such that runoff is prevented from draining into the tree well (e.g., a curb inlet opening is blocked by debris or a grate is clogged causing runoff to flow around instead of into the tree well, or a surface depression has been filled so runoff flows away from the tree well), the BMP is not performing as intended to protect downstream waterways from pollution and/or erosion. Corrective maintenance will be required to restore drainage into the tree well as designed.

Surface ponding of runoff directed into tree wells is expected to infiltrate/evapotranspire within 24-96 hours following a storm event. Surface ponding longer than approximately 24 hours following a storm event may be detrimental to vegetation health, and surface ponding longer than approximately 96 hours following a storm event poses a risk of vector (mosquito) breeding. Poor drainage can result from clogging or compaction of the soils surrounding the tree. Loosen or replace the soils to restore drainage.

**Other Special Considerations.** Site design BMPs, such as tree wells, installed within a new development or redevelopment project are components of an overall storm water management strategy for the project. The presence of site design BMPs within a project is usually a factor in the determination of the amount of runoff to be managed with structural BMPs (i.e., the amount of runoff expected to reach downstream retention or biofiltration basins that process storm water runoff from the project as a whole). When site design BMPs are not maintained or are removed, this can lead to clogging or failure of downstream structural BMPs due to greater delivery of runoff and pollutants than intended for the structural BMP. Therefore, the City Engineer may require confirmation of maintenance of site design BMPs as part of their structural BMP maintenance documentation requirements. Site design BMPs that have been installed as part of the project should not be removed, nor should they be bypassed by re-routing roof drains or re-grading surfaces within the project. If changes are necessary, consult the City Engineer to determine requirements.

Consider the effects of BMP design and tributary area land uses on the clogging potential of the BMP. If the Tree well is designed with dimensions outside the ranges recommended in this fact sheet (i.e. higher loading rate), or will treat runoff from erosion prone tributary land uses, complete the sediment loading analysis included in Appendix E.27.

Plot tree wells designed for tree credit volume or pollutant control to ultimate canopy size on plans.

**Summary of Standard Inspection and Maintenance**

The property owner is responsible to ensure inspection, operation and maintenance of permanent BMPs on their property unless responsibility has been formally transferred to an agency, community facilities district, homeowners association, property owners association, or other special district.

Maintenance frequencies listed in this table are average/typical frequencies. Actual maintenance needs are site-specific, and maintenance may be required more frequently. Maintenance must be performed whenever needed, based on maintenance indicators presented in this table. The BMP owner is responsible for conducting regular inspections to see when maintenance is needed based on the maintenance indicators. During the first year of operation of a structural BMP, inspection is recommended at least once prior to August 31 and then monthly from September through May. Inspection during a storm event is also recommended. After the initial period of frequent inspections, the minimum inspection and maintenance frequency can be determined based on the results of the first year inspections.

Threshold/Indicator	Maintenance Action	Typical Maintenance Frequency
Tree health	Routine actions as necessary to maintain tree health.	<ul style="list-style-type: none"> <li>• Inspect monthly.</li> <li>• Maintain when needed.</li> </ul>
Dead or diseased tree	Remove dead or diseased tree. Replace per original plans.	<ul style="list-style-type: none"> <li>• Inspect monthly.</li> <li>• Maintain when needed.</li> </ul>
Standing water in tree well for longer than 24 hours following a storm event  Surface ponding longer than approximately 24 hours following a storm event may be detrimental to tree health	Loosen or replace soils surrounding the tree to restore drainage.	<ul style="list-style-type: none"> <li>• Inspect monthly and after every 0.5-inch or larger storm event. If standing water is observed, increase inspection frequency to after every 0.1-inch or larger storm event.</li> <li>• Maintain when needed.</li> </ul>
Presence of mosquitos/larvae  For images of egg rafts, larva, pupa, and adult mosquitos, see <a href="http://www.mosquito.org/biology">http://www.mosquito.org/biology</a>	Disperse any standing water from the tree well to nearby landscaping. Loosen or replace soils surrounding the tree to restore drainage (and prevent standing water).	<ul style="list-style-type: none"> <li>• Inspect monthly and after every 0.5-inch or larger storm event. If mosquitos are observed, increase inspection frequency to after every 0.1-inch or larger storm event.</li> <li>• Maintain when needed</li> </ul>

Threshold/Indicator	Maintenance Action	Typical Maintenance Frequency
<p>Entrance / opening to the tree well is blocked such that storm water will not drain into the tree well (e.g., a curb inlet opening is blocked by debris or a grate is clogged causing runoff to flow around instead of into the tree well; or a surface depression is filled such that runoff drains away from the tree well)</p>	<p>Make repairs as appropriate to restore drainage into the tree well.</p>	<ul style="list-style-type: none"> <li>• Inspect monthly.</li> <li>• Maintain when needed.</li> </ul>

## E.7 SD-B Impervious Area Dispersion



*Photo Credit: Orange County Technical Guidance Document*

---

**MS4 Permit Category**

---

Site Design

---

**Manual Category**

---

Site Design

---

**Applicable Performance Criteria**

---

Site Design

---

**Primary Benefits**

---

Volume Reduction

Peak Flow Attenuation

### **Description**

Impervious area dispersion (dispersion) refers to the practice of effectively disconnecting impervious areas from directly draining to the storm drain system by routing runoff from impervious areas such as rooftops (through downspout disconnection), walkways, and driveways onto the surface of adjacent pervious areas. The intent is to slow runoff discharges, and reduce volumes. Dispersion with partial or full infiltration results in significant volume reduction by means of infiltration and evapotranspiration.

Typical dispersion components include:

- An impervious surface from which runoff flows will be routed with minimal piping to limit concentrated inflows
- Splash blocks, flow spreaders, or other means of dispersing concentrated flows and providing energy dissipation as needed
- Dedicated pervious area, typically vegetated, with in-situ soil infiltration capacity for partial or full infiltration
- Optional soil amendments to improve vegetation support, maintain infiltration rates and enhance treatment of routed flows
- Overflow route for excess flows to be conveyed from dispersion area to the storm drain system or discharge point

E.7: SD-B Impervious Area Dispersion

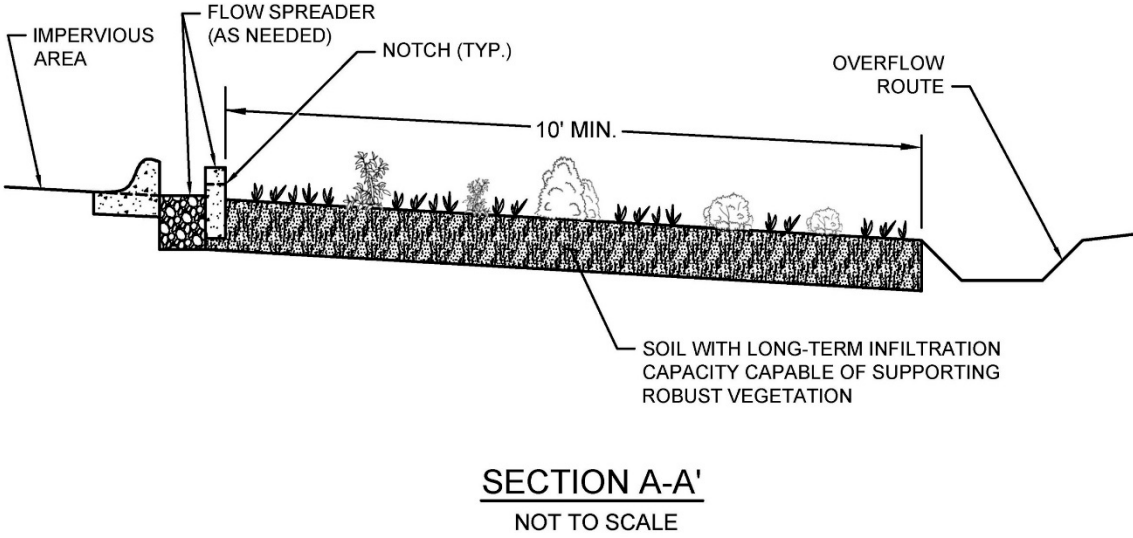
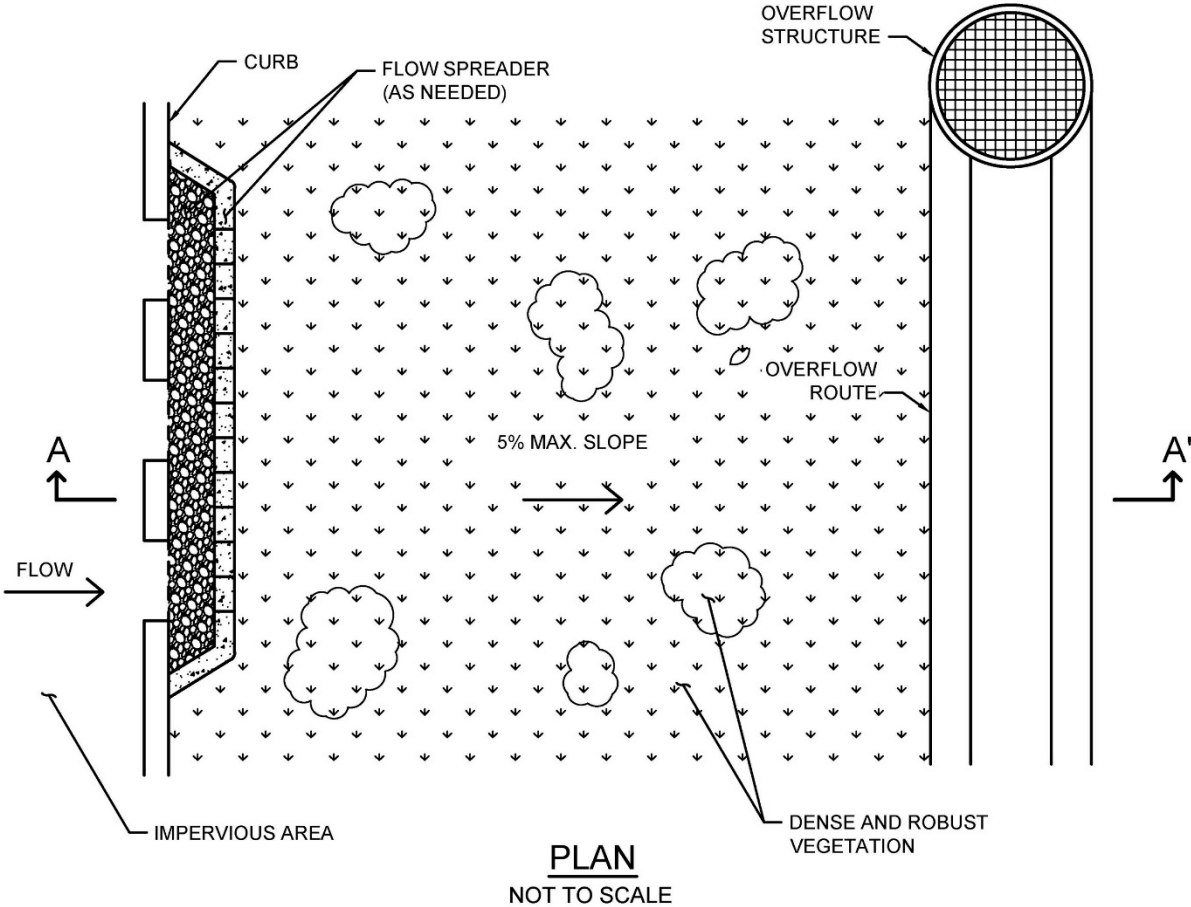



Typical plan and section view of an Impervious Area Dispersion BMP

**Design Adaptations for Project Goals**

**Site design BMP to reduce impervious area and DCV.** Impervious area dispersion primarily functions as a site design BMP for reducing the effective imperviousness of a site by providing partial or full infiltration of the flows that are routed to pervious dispersion areas and otherwise slowing down excess flows that eventually reach the storm drain system. This can significantly reduce the DCV for the site.

**Design Criteria and Considerations**

**Dispersion** must meet the following design criteria. Deviations from the below criteria may be approved at the discretion of the City Engineer if it is determined to be appropriate:

<i>Siting and Design</i>	<i>Intent/Rationale</i>
<input type="checkbox"/> Dispersion is over areas with soil types capable of supporting or being amended (e.g., with sand or compost) to support vegetation. Media amendments must be tested to verify that they are not a source of pollutants.	Soil must have long-term infiltration capacity for partial or full infiltration and be able to support vegetation to provide runoff treatment. Amendments to improve plant growth must not have negative impact on water quality.
<input type="checkbox"/> Dispersion has vegetated sheet flow over a relatively large distance (minimum 10 feet) from inflow to overflow route.	Full or partial infiltration requires relatively large areas to be effective depending on the permeability of the underlying soils.
<input type="checkbox"/> Pervious areas should be flat (with less than 5% slopes) and vegetated.	Flat slopes facilitate sheet flows and minimize velocities, thereby improving treatment and reducing the likelihood of erosion.
<b><i>Inflow velocities</i></b>	
<input type="checkbox"/> Inflow velocities are limited to 3 ft/s or less or use energy dissipation methods (e.g., riprap, level spreader) for concentrated inflows.	High inflow velocities can cause erosion, scour and/or channeling.
<b><i>Dedication</i></b>	
<input type="checkbox"/> Dispersion areas must be owned by the project owner and be dedicated for the purposes of dispersion to the exclusion of other future uses	Dedicated dispersion areas prevent future conversion to alternate uses and facilitate continued full and partial infiltration benefits.

<i>Siting and Design</i>	<i>Intent/Rationale</i>
that might reduce the effectiveness of the dispersion area.	
<hr/>	
<i>Vegetation</i>	
<input type="checkbox"/> Dispersion typically requires dense and robust vegetation for proper function. Drought tolerant species should be selected to minimize irrigation needs. A plant list to aid in selection can be found in Appendix E.26.	Vegetation improves resistance to erosion and aids in runoff treatment.

**Conceptual Design and Sizing Approach for Site Design**

1. Determine the areas where dispersion can be used in the site design to reduce the DCV for pollutant control sizing.
2. Calculate the DCV for storm water pollutant control per Appendix B.2, taking into account reduced runoff from dispersion.
3. Determine if a DMA is considered “Self-retaining” if the impervious to pervious ratio is:
  - a. 2:1 when the pervious area is composed of Hydrologic Soil Group A
  - b. 1:1 when the pervious area is composed of Hydrologic Soil Group B

**Conceptual Design and Sizing Approach for Storm Water Pollutant Treatment and Flow Control**

DMA's using impervious area dispersion are considered to meet both pollutant control and hydromodification flow control requirements if ALL of the following criteria are met:

1. All impervious area within the DMA discharges to the pervious area before the runoff discharges from the DMA.
2. As a minimum, the top 11 inches of the pervious area uses amended soils in accordance with the SD-F fact sheet and the pervious area also meets the requirements for dispersion (e.g. slope, inflow velocities, etc.) in the SD-B fact sheet.
3. The impervious to pervious area ratio is 1:1 or less.

**Maintenance Overview**

**Normal Expected Maintenance.** Vegetated area shall be maintained as part of normal landscape maintenance. Additionally, ensure that storm water runoff can be conveyed into the vegetated area as designed. That is, the mechanism that allows storm water runoff from impervious area to flow into the pervious area (e.g., a curb cut allows runoff from a parking lot to drain onto adjacent landscaping

## E.7: SD-B Impervious Area Dispersion

area, or a roof drain outlet is directed to a lawn) shall not be removed, blocked, filled, or otherwise changed in a manner that prevents storm water from draining into the pervious area. A summary table of standard inspection and maintenance indicators is provided within this Fact Sheet.

**Non-Standard Maintenance or BMP Failure.** Impervious area dispersion is a site design BMP that normally does not require maintenance actions beyond routine landscape maintenance. If changes have been made to the area, such as the vegetated area has been replaced with impervious area, or the mechanism that allows storm water runoff from impervious area to flow into the pervious area has been removed (e.g., roof drains previously directed to vegetated area have been directly connected to the street or storm drain system), the BMP is not performing as intended to protect downstream waterways from pollution and/or erosion. Corrective maintenance will be required to restore drainage into the pervious area as designed. If the pervious area has been removed, contact the City Engineer to determine a solution.

Runoff directed into vegetated areas is expected to be drained within 24-96 hours following a storm event. Surface ponding longer than approximately 24 hours following a storm event may be detrimental to vegetation health, and surface ponding longer than approximately 96 hours following a storm event poses a risk of vector (mosquito) breeding. Poor drainage can result from clogging or compaction of the soils. Loosen or replace the soils to restore drainage.

**Other Special Considerations.** Site design BMPs, such as impervious area dispersion, installed within a new development or redevelopment project are components of an overall storm water management strategy for the project. The presence of site design BMPs within a project is usually a factor in the determination of the amount of runoff to be managed with structural BMPs (i.e., the amount of runoff expected to reach downstream retention or biofiltration basins that process storm water runoff from the project as a whole). When site design BMPs are not maintained or are removed, this can lead to clogging or failure of downstream structural BMPs due to greater delivery of runoff and pollutants than intended for the structural BMP. Therefore, the City Engineer may require confirmation of maintenance of site design BMPs as part of their structural BMP maintenance documentation requirements. Site design BMPs that have been installed as part of the project should not be removed, nor should they be bypassed by re-routing roof drains or re-grading surfaces within the project. If changes are necessary, consult the City Engineer to determine requirements.

**Summary of Standard Inspection and Maintenance**

The property owner is responsible to ensure inspection, operation and maintenance of permanent BMPs on their property unless responsibility has been formally transferred to an agency, community facilities district, homeowners association, property owners association, or other special district.

Maintenance frequencies listed in this table are average/typical frequencies. Actual maintenance needs are site-specific, and maintenance may be required more frequently. Maintenance must be performed whenever needed, based on maintenance indicators presented in this table. The BMP owner is responsible for conducting regular inspections to see when maintenance is needed based on the maintenance indicators. During the first year of operation of a structural BMP, inspection is recommended at least once prior to August 31 and then monthly from September through May. Inspection during a storm event is also recommended. After the initial period of frequent inspections, the minimum inspection and maintenance frequency can be determined based on the results of the first year inspections.

Threshold/Indicator	Maintenance Action	Typical Maintenance Frequency
Poor vegetation establishment	Re-seed, re-plant, or re-establish vegetation per original plans.	<ul style="list-style-type: none"> <li>• Inspect monthly.</li> <li>• Maintain when needed.</li> </ul>
Dead or diseased vegetation	Remove dead or diseased vegetation, re-seed, re-plant, or re-establish vegetation per original plans.	<ul style="list-style-type: none"> <li>• Inspect monthly.</li> <li>• Maintain when needed.</li> </ul>
Overgrown vegetation	Mow or trim as appropriate.	<ul style="list-style-type: none"> <li>• Inspect monthly.</li> <li>• Maintain when needed.</li> </ul>
Standing water in vegetated pervious area for longer than 24 hours following a storm event  Surface ponding longer than approximately 24 hours following a storm event may be detrimental to vegetation health	Disperse any areas of standing water to nearby landscaping (i.e., spread it out to another portion of the pervious area so it drains into the soil). Make appropriate corrective measures such as adjusting irrigation system, or repairing/replacing clogged or compacted soils.	<ul style="list-style-type: none"> <li>• Inspect monthly and after every 0.5-inch or larger storm event. If standing water is observed, increase inspection frequency to after every 0.1-inch or larger storm event.</li> <li>• Maintain when needed.</li> </ul>

E.7: SD-B Impervious Area Dispersion

Threshold/Indicator	Maintenance Action	Typical Maintenance Frequency
<p>Presence of mosquitos/larvae</p> <p>For images of egg rafts, larva, pupa, and adult mosquitos, see <a href="http://www.mosquito.org/biology">http://www.mosquito.org/biology</a></p>	<p>Disperse any areas of standing water to nearby landscaping (i.e., spread it out to another portion of the pervious area so it drains into the soil). Loosen or replace soils to restore drainage (and prevent standing water)</p>	<ul style="list-style-type: none"> <li>• Inspect monthly and after every 0.5-inch or larger storm event. If mosquitos are observed, increase inspection frequency to after every 0.1-inch or larger storm event.</li> <li>• Maintain when needed</li> </ul>
<p>Entrance / opening to the vegetated pervious area is blocked such that storm water from impervious area will not drain into the pervious area (e.g., a curb cut opening is blocked by debris or a roof drain outlet has been directly connected to the storm drain system)</p>	<p>Make repairs as appropriate to restore drainage into the vegetated pervious area.</p>	<ul style="list-style-type: none"> <li>• Inspect monthly.</li> <li>• Maintain when needed.</li> </ul>

# E.8 SD-C Green Roofs



**MS4 Permit Category**

Site Design

**Manual Category**

Site Design

**Applicable Performance Standard**

Site Design

**Primary Benefits**

- Volume Reduction
- Peak Flow Attenuation

*Location: County of San Diego Operations Center, San Diego, California*

**Description**

Green roofs are vegetated rooftop systems that reduce runoff volumes and rates, treat storm water pollutants through filtration and plant uptake, provide additional landscape amenity, and create wildlife habitat. Additionally, green roofs reduce the heat island effect and provide acoustical control, air filtration and oxygen production. In terms of building design, they can protect against ultraviolet rays and extend the roof lifetime, as well as increase the building insulation, thereby decreasing heating and cooling costs. There are two primary types of green roofs:

- **Extensive** – lightweight, low maintenance system with low-profile, drought tolerant type groundcover in shallow growing medium (6 inches or less)
- **Intensive** – heavyweight, high maintenance system with a more garden-like configuration and diverse plantings that may include shrubs or trees in a thicker growing medium (greater than 6 inches)

Typical green roof components include, from top to bottom:

- Vegetation that is appropriate to the type of green roof system, climate, and watering conditions

- Media layer (planting mix or engineered media) capable of supporting vegetation growth
- Filter fabric to prevent migration of fines (soils) into the drainage layer
- Optional drainage layer to convey excess runoff
- Optional root barrier
- Optional insulation layer
- Waterproof membrane
- Structural roof support capable of withstanding the additional weight of a green roof

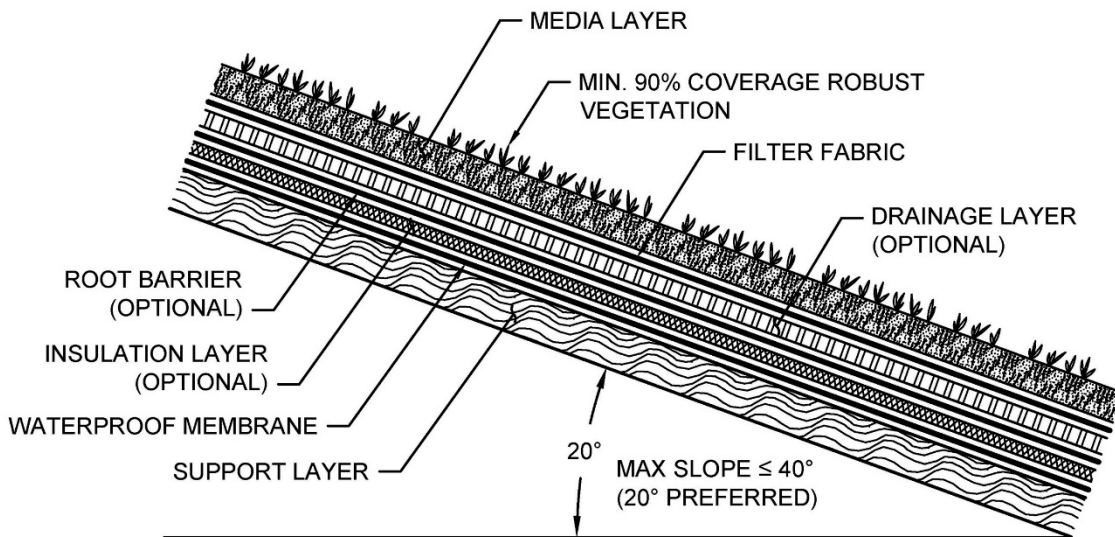

**PROFILE**  
NOT TO SCALE

**Typical profile of a Green Roof BMP**

**Design Adaptations for Project Goals**

**Site design BMP to provide incidental treatment.** Green roofs can be used as a site design feature to reduce the runoff generated from the site through replacing conventional roofing. This can reduce the DCV and flow control requirements for the site.

**Design Criteria and Considerations**

Green roofs must meet the following design criteria. Deviations from the below criteria may be approved at the discretion of the City Engineer if it is determined to be appropriate:

<i>Siting and Design</i>	<i>Intent/Rationale</i>
<input type="checkbox"/> Roof slope is $\leq 40\%$ (Roofs that are $\leq 20\%$ are preferred).	Steep roof slopes increases project complexity and requires supplemental anchoring.
<input type="checkbox"/> Structural roof capacity design supports the calculated additional load (lbs/sq. ft) of the vegetation growing medium and additional drainage and barrier layers.	Inadequate structural capacity increases the risk for roof failure and harm to the building and occupants.
<input type="checkbox"/> Design and construction is planned to be completed by an experienced green roof specialist.	A green roof specialist will minimize complications in implementation and potential structural issues that are critical to green roof success.
<input type="checkbox"/> Green roof location and extent must meet fire safety provisions.	Green roof design must not negatively impact fire safety.
<input type="checkbox"/> Maintenance access is included in the green roof design.	Maintenance will facilitate proper functioning of drainage and irrigation components and allow for removal of undesirable vegetation and soil testing, as needed.
<b><i>Vegetation</i></b>	
<input type="checkbox"/> Vegetation is suitable for the green roof type, climate and expected watering conditions. Perennial, self-sowing plants that are drought-tolerant (e.g., sedums, succulents) and require little to no fertilizer, pesticides or herbicides are recommended. Vegetation pre-grown at grade may allow plants to establish prior to facing harsh roof conditions.	Plants suited to the design and expected growing environment are more likely to survive.
<input type="checkbox"/> Vegetation is capable of covering $\geq 90\%$ the roof surface.	Benefits of green roofs are greater with more surface vegetation.
<input type="checkbox"/> Vegetation is robust and erosion-resistant in order to withstand the anticipated rooftop environment (e.g., heat, cold, high winds).	Weak plants will not survive in extreme rooftop environments.
<input type="checkbox"/> Vegetation is fire resistant.	Vegetation that will not burn easily decreases the chance for fire and harm to the building and occupants.



<i>Siting and Design</i>	<i>Intent/Rationale</i>
<input type="checkbox"/> Vegetation considers roof sun exposure and shaded areas based on roof slope and location.	The amount of sunlight the vegetation receives can inhibit growth therefore the beneficial effects of a vegetated roof.
<input type="checkbox"/> An irrigation system (e.g., drip irrigation system) is included as necessary to maintain vegetation.	Proper watering will increase plant survival, especially for new plantings.
<input type="checkbox"/> Media is well-drained and is the appropriate depth required for the green roof type and vegetation supported.	Unnecessary water retention increases structural loading. An adequate media depth increases plant survival.
<input type="checkbox"/> A filter fabric is used to prevent migration of media fines through the system.	Migration of media can cause clogging of the drainage layer.
<input type="checkbox"/> A drainage layer is provided if needed to convey runoff safely from the roof. The drainage layer can be comprised of gravel, perforated sheeting, or other drainage materials.	Inadequate drainage increases structural loading and the risk of harm to the building and occupants.
<input type="checkbox"/> A root barrier comprised of dense material to inhibit root penetration is used if the waterproof membrane will not provide root penetration protection.	Root penetration can decrease the integrity of the underlying structural roof components and increase the risk of harm to the building and occupants.
<input type="checkbox"/> An insulation layer is included as needed to protect against the water in the drainage layer from extracting building heat in the winter and cool air in the summer.	Regulating thermal impacts of green roofs will aid in controlling building heating and cooling costs.
<input type="checkbox"/> A waterproof membrane is used to prevent the roof runoff from vertically migrating and damaging the roofing material. A root barrier may be required to prevent roots from compromising the integrity of the membrane.	Water-damaged roof materials increase the risk of harm to the building and occupants.

**Conceptual Design and Sizing Approach for Site Design**

1. Determine the areas where green roofs can be used in the site design to replace conventional roofing to reduce the DCV. These green roof areas can be credited toward reducing runoff generated through representation in storm water calculations as pervious, not impervious, areas but are not credited for storm water pollutant control.

2. Calculate the DCV per Appendix B.2.

### **Maintenance Overview**

**Normal Expected Maintenance.** A green roof requires routine maintenance to: maintain vegetation health; and maintain integrity of the roof drainage system. A summary table of standard inspection and maintenance indicators is provided within this Fact Sheet.

**Non-Standard Maintenance or BMP Failure.** Green roofs are site design BMPs that normally do not require maintenance actions beyond the normal maintenance described above. If a roof leak is discovered, it may be an indicator that the waterproof membrane has failed. The waterproof membrane (roof liner) shall be inspected and repaired or replaced as necessary.

Green roof systems normally receive only direct rainfall (not runoff from additional tributary area directed into the system). It is expected to be drained within 24-96 hours following a storm event. Surface ponding longer than approximately 24 hours following a storm event may be detrimental to vegetation health, and surface ponding longer than approximately 96 hours following a storm event poses a risk of vector (mosquito) breeding, as well as risk of damage to the roof. Poor drainage can result from clogging or compaction of the media, optional drainage layer, or drainage system. The specific cause of the drainage issue must be determined and corrected.

**Other Special Considerations.** Site design BMPs, such as green roofs, installed within a new development or redevelopment project are components of an overall storm water management strategy for the project. The presence of site design BMPs within a project is usually a factor in the determination of the amount of runoff to be managed with structural BMPs (i.e., the amount of runoff expected to reach downstream retention or biofiltration basins that process storm water runoff from the project as a whole). When site design BMPs are not maintained or are removed, this can lead to clogging or failure of downstream structural BMPs due to greater delivery of runoff and pollutants than intended for the structural BMP. Therefore, the City Engineer may require confirmation of maintenance of site design BMPs as part of their structural BMP maintenance documentation requirements. Site design BMPs that have been installed as part of the project should not be removed, nor should they be bypassed by re-routing roof drains or re-grading surfaces within the project. If changes are necessary, consult the City Engineer to determine requirements.

**Summary of Standard Inspection and Maintenance**

The property owner is responsible to ensure inspection, operation and maintenance of permanent BMPs on their property unless responsibility has been formally transferred to an agency, community facilities district, homeowners association, property owners association, or other special district.

Maintenance frequencies listed in this table are average/typical frequencies. Actual maintenance needs are site-specific, and maintenance may be required more frequently. Maintenance must be performed whenever needed, based on maintenance indicators presented in this table. The BMP owner is responsible for conducting regular inspections to see when maintenance is needed based on the maintenance indicators. During the first year of operation of a structural BMP, inspection is recommended at least once prior to August 31 and then monthly from September through May. Inspection during a storm event is also recommended. After the initial period of frequent inspections, the minimum inspection and maintenance frequency can be determined based on the results of the first year inspections.

Threshold/Indicator	Maintenance Action	Typical Maintenance Frequency
Poor vegetation establishment	Re-seed, re-plant, or re-establish vegetation per original plans.	<ul style="list-style-type: none"> <li>• Inspect monthly.</li> <li>• Maintain when needed.</li> </ul>
Dead or diseased vegetation	Remove dead or diseased vegetation, re-seed, re-plant, or re-establish vegetation per original plans.	<ul style="list-style-type: none"> <li>• Inspect monthly.</li> <li>• Maintain when needed.</li> </ul>
Overgrown vegetation	Mow or trim as appropriate.	<ul style="list-style-type: none"> <li>• Inspect monthly.</li> <li>• Maintain when needed.</li> </ul>

Threshold/Indicator	Maintenance Action	Typical Maintenance Frequency
<p>Standing water in BMP for longer than 24 hours following a storm event</p> <p>Surface ponding longer than approximately 24 hours following a storm event may be detrimental to vegetation health</p>	<p>Disperse any areas of standing water to nearby landscaping (i.e., spread it out to another portion of the green roof so it drains into the soil). Make appropriate corrective measures such as adjusting irrigation system, clearing underdrains, or repairing/replacing clogged or compacted soils.</p>	<ul style="list-style-type: none"> <li>• Inspect monthly and after every 0.5-inch or larger storm event. If standing water is observed, increase inspection frequency to after every 0.1-inch or larger storm event.</li> <li>• Maintain when needed.</li> </ul>
<p>Presence of mosquitos/larvae</p> <p>For images of egg rafts, larva, pupa, and adult mosquitos, see <a href="http://www.mosquito.org/biology">http://www.mosquito.org/biology</a></p>	<p>Disperse any areas of standing water to nearby landscaping (i.e., spread it out to another portion of the green roof so it drains into the soil). Loosen or replace soils to restore drainage (and prevent standing water).</p>	<ul style="list-style-type: none"> <li>• Inspect monthly and after every 0.5-inch or larger storm event. If mosquitos are observed, increase inspection frequency to after every 0.1-inch or larger storm event.</li> <li>• Maintain when needed</li> </ul>
<p>Leaks or other damage to waterproof membrane</p>	<p>Repair or replace as applicable.</p>	<ul style="list-style-type: none"> <li>• Inspect membrane if leak is observed.</li> <li>• Maintain when needed.</li> </ul>

## E.9 SD-D Permeable Pavement (Site Design BMP)



Photo Credit: San Diego Low Impact Development Design Manual

---

**MS4 Permit Category**

---

Site Design

---

**Manual Category**

---

Site Design

---

**Applicable Performance Standard**

---

Site Design

---

**Primary Benefits**

---

**Description**

Permeable pavement is pavement that allows for percolation through void spaces in the pavement surface into subsurface layers. Permeable pavements reduce runoff volumes and rates and can provide pollutant control via infiltration, filtration, sorption, sedimentation, and biodegradation processes. When used as a site design BMP, the subsurface layers are designed to provide storage of storm water runoff so that outflow rates can be controlled via infiltration into subgrade soils. Varying levels of storm water treatment and flow control can be provided depending on the size of the permeable pavement system relative to its drainage area and the underlying infiltration rates. As a site design BMP permeable pavement areas are designed to be self-retaining and are designed primarily for direct rainfall. Self-retaining permeable pavement areas have a ratio of total drainage area (including permeable pavement) to area of permeable pavement of 1.5:1 or less. Permeable pavement surfaces can be constructed from modular paver units or paver blocks, pervious concrete, porous asphalt, and turf pavers. Sites designed with permeable pavements can significantly reduce the impervious area of the project. Reduction in impervious surfaces decreases the DCV and can reduce the footprint of treatment control and flow control BMPs.

<b>Typical Permeable Pavement Components (Top to Bottom)</b>
Permeable surface layer
Bedding layer for permeable surface
Aggregate storage layer with optional underdrain(s)
Optional final filter course layer over uncompacted existing subgrade

**Design Adaptations for Project Goals**

Site design BMP to reduce impervious area and DCV. Permeable pavement without an

## E.9: SD-D Permeable Pavement (Side Design BMP)

underdrain can be used as a site design feature to reduce the impervious area of the site by replacing traditional pavements, including roadways, parking lots, emergency access lanes, sidewalks, trails and driveways.

### **Conceptual Design and Sizing Approach for Site Design**

1. Determine the areas where permeable pavements can be used in the site design to replace conventional pavements to reduce the DCV. These areas can be credited toward reducing runoff generated through representation in storm water calculations as pervious, not impervious, areas but are not credited for storm water pollutant control.
2. Calculate the DCV per Appendix B.2, taking into account reduced runoff from permeable pavement areas.

### **Maintenance Overview**

**Normal Expected Maintenance.** Routine maintenance of permeable pavement includes: removal of materials such as trash and debris accumulated on the paving surface; vacuuming of the paving surface to prevent clogging; and flushing paving and subsurface gravel to remove fine sediment. If the BMP includes underdrains, check and clear underdrains. A summary table of standard inspection and maintenance indicators is provided within this Fact Sheet.

**Non-Standard Maintenance or BMP Failure.** If the permeable pavement area is not drained between storm events, or if runoff sheet flows across the permeable pavement area and flows off the permeable pavement area during storm events, the BMP is not performing as intended to protect downstream waterways from pollution and/or erosion. During storm events up to the 85th percentile storm event (approximately 0.5 to 1 inch of rainfall in San Diego County), runoff should not flow off the permeable pavement area. The permeable pavement area is expected to have adequate hydraulic conductivity and storage such that rainfall landing on the permeable pavement and runoff from the surrounding drainage area will go directly into the pavement without ponding or overflow (in properly designed systems, the surrounding drainage area is not more than half as large as the permeable pavement area). Following the storm event, there should be no standing water (puddles) on the permeable pavement area.

If storm water is flowing off the permeable pavement during a storm event, or if there is standing water on the permeable pavement surface following a storm event, this is an indicator of clogging somewhere within the system. Poor drainage can result from clogging of the permeable surface layer, any of the subsurface components, or the subgrade soils. The specific cause of the drainage issue must be determined and corrected. Surface or subsurface ponding longer than approximately 96 hours following a storm event poses a risk of vector (mosquito) breeding. Corrective maintenance, increased inspection and maintenance, BMP replacement, or a different BMP type will be required. If poor drainage persists after flushing of the paving, subsurface gravel, and/or underdrain(s) when applicable,

## E.9: SD-D Permeable Pavement (Side Design BMP)

or if it is determined that the underlying soils do not have the infiltration capacity expected, the City Engineer shall be contacted prior to any additional repairs or reconstruction.

**Other Special Considerations.** Site design BMPs, such as permeable pavement, installed within a new development or redevelopment project are components of an overall storm water management strategy for the project. The presence of site design BMPs within a project is usually a factor in the determination of the amount of runoff to be managed with structural BMPs (i.e., the amount of runoff expected to reach downstream retention or biofiltration basins that process storm water runoff from the project as a whole). When site design BMPs are not maintained or are removed, this can lead to clogging or failure of downstream structural BMPs due to greater delivery of runoff and pollutants than intended for the structural BMP. Therefore, the City Engineer may require confirmation of maintenance of site design BMPs as part of their structural BMP maintenance documentation requirements. Site design BMPs that have been installed as part of the project should not be removed, nor should they be bypassed by re-routing roof drains or re-grading surfaces within the project. If changes are necessary, consult the City Engineer to determine requirements.

The runoff storage and infiltration surface area in this BMP are not readily accessible because they are subsurface. This means that clogging and poor drainage are not easily corrected. If the tributary area draining to the BMP includes unpaved areas, the sediment load from the tributary drainage area can be too high, reducing BMP function or clogging the BMP. All unpaved areas within the tributary drainage area should be stabilized with vegetation. Other pretreatment components to prevent transport of sediment to the paving surface, such as grass buffer strips, will extend the life of the subsurface components and infiltration surface. Along with proper stabilization measures and pretreatment within the tributary area, routine maintenance, including preventive vacuum/regenerative air street sweeping, is key to preventing clogging.

City shall have the right to require qualified third-party testing at the property owner's expense when a poor drainage condition is suspected. The project owner will be required to repair or reinstall any failing permeable surface to standards established in the approved grading permit.

**Summary of Standard Inspection and Maintenance**

The property owner is responsible to ensure inspection, operation and maintenance of permanent BMPs on their property unless responsibility has been formally transferred to an agency, community facilities district, homeowners association, property owners association, or other special district.

Maintenance frequencies listed in this table are average/typical frequencies. Actual maintenance needs are site-specific, and maintenance may be required more frequently. Maintenance must be performed whenever needed, based on maintenance indicators presented in this table. The BMP owner is responsible for conducting regular inspections to see when maintenance is needed based on the maintenance indicators. During the first year of operation of a structural BMP, inspection is recommended at least once prior to August 31 and then monthly from September through May. Inspection during a storm event is also recommended. After the initial period of frequent inspections, the minimum inspection and maintenance frequency can be determined based on the results of the first year inspections.

Threshold/Indicator	Maintenance Action	Typical Maintenance Frequency
Preventive vacuum/regenerative air street sweeping	Pavement should be swept with a vacuum power or regenerative air street sweeper to maintain infiltration through paving surface	<ul style="list-style-type: none"> <li>• Schedule/perform this preventive action at least twice per year.</li> </ul>
Accumulation of sediment, litter, or debris on permeable pavement surface	Remove and properly dispose of accumulated materials. Inspect tributary area for exposed soil or other sources of sediment and apply stabilization measures to sediment source areas. Apply source control measures as applicable to sources of litter or debris.	<ul style="list-style-type: none"> <li>• Inspect monthly and after every 0.5-inch or larger storm event.</li> <li>• Remove any accumulated materials found at each inspection.</li> </ul>



**E.9: SD-D Permeable Pavement (Side Design BMP)**

Threshold/Indicator	Maintenance Action	Typical Maintenance Frequency
Weeds growing on/through the permeable pavement surface	Remove weeds and add features as necessary to prevent weed intrusion. Use non-chemical methods (e.g., instead of pesticides, control weeds using mechanical removal, physical barriers, and/or physical changes in the surrounding area adjacent to pavement that will preclude weed intrusion into the pavement).	<ul style="list-style-type: none"> <li>• Inspect monthly.</li> <li>• Remove any weeds found at each inspection.</li> </ul>
Standing water in permeable paving area following a storm event, or runoff is observed overflowing off the permeable paving surface during a storm event	This condition requires investigation of why infiltration is not occurring. If feasible, corrective action shall be taken to restore infiltration (e.g., pavement should be swept with a vacuum power or regenerative air street sweeper to restore infiltration rates, clear underdrains if underdrains are present). BMP may require retrofit if infiltration cannot be restored. The City Engineer shall be contacted prior to any repairs or reconstruction.	<ul style="list-style-type: none"> <li>• Inspect monthly and after every 0.5-inch or larger storm event. If standing water is observed, increase inspection frequency to after every 0.1-inch or larger storm event.</li> <li>• Maintain when needed.</li> </ul>

**E.9: SD-D Permeable Pavement (Side Design BMP)**

Threshold/Indicator	Maintenance Action	Typical Maintenance Frequency
<p>Presence of mosquitos/larvae</p> <p>For images of egg rafts, larva, pupa, and adult mosquitos, see <a href="http://www.mosquito.org/biology">http://www.mosquito.org/biology</a></p>	<p>If mosquitos/larvae are observed: first, immediately remove any standing water by dispersing to nearby landscaping; second, make corrective measures as applicable to restore BMP drainage to prevent standing water.</p> <p>If mosquitos persist following corrective measures to remove standing water, or if the BMP design does not meet the 96-hour drawdown criteria because the underlying soils do not have the infiltration capacity expected, the City Engineer shall be contacted to determine a solution. A different BMP type, or a Vector Management Plan prepared with concurrence from the County of San Diego Department of Environmental Health, may be required.</p>	<ul style="list-style-type: none"> <li>• Inspect monthly and after every 0.5-inch or larger storm event. If mosquitos are observed, increase inspection frequency to after every 0.1-inch or larger storm event.</li> <li>• Maintain when needed.</li> </ul>
<p>Damage to permeable paving surface (e.g., cracks, settlement, misaligned paver blocks, void spaces between paver blocks need fill materials replenished)</p>	<p>Repair or replace damaged surface as appropriate.</p>	<ul style="list-style-type: none"> <li>• Inspect annually.</li> <li>• Maintain when needed.</li> </ul>

## E.10 SD-E Rain Barrels



Photo Credit: San Diego Low Impact Development Design Manual

---

**MS4 Permit Category**

---

Site Design

---

**Manual Category**

---

Site Design

---

**Applicable Performance Standard**

---

Site Design

---

**Primary Benefits**

---

**Description**

Rain barrels are containers that can capture rooftop runoff and store it for future use. With controlled timing and volume release, the captured rainwater can be used for irrigation or alternative grey water between storm events, thereby reducing runoff volumes and associated pollutants to downstream waterbodies. Rain barrels tend to be smaller systems, less than 100 gallons. They have low installation costs. Treatment can be achieved when rain barrels are used as part of a treatment train along with other BMPs that use captured flows in applications that do not result in discharges into the storm drain system. Rooftops are the ideal tributary areas for rain barrels. Due to Escondido’s arid climate, some rain barrels may fill only a few times each year.

Typical Rain Barrel Components
Storage container, barrel or tank for holding captured flows
Inlet and associated valves and piping
Outlet and associated valves and piping
Overflow outlet
Optional pump
Optional first flush diverters
Optional roof, supports, foundation, level indicator, and other accessories

**Design Adaptations for Project Goals**

**Site design BMP to reduce effective impervious area and DCV.** Barrels can be used as a site design feature to reduce the effective impervious area of the site by removing roof runoff from the site discharge. This can reduce the DCV and flow control requirements for the site.

**Conceptual Design and Sizing Approach for Site Design**

1. Determine the areas where rain barrels can be used in the site design to capture roof runoff to reduce the DCV. Rain barrels reduce the effective impervious area of the site by removing

roof runoff from the site discharge.

2. Calculate the DCV per Appendix B.2, taking into account reduced runoff from permeable pavement areas.

### **Maintenance Overview**

**Normal Expected Maintenance.** Rain barrels can be expected to accumulate some debris that is small enough to pass through the inlet into the storage container. Leaves may accumulate at the inlet. Ancillary parts including valves, piping, screens, level indicators, and other accessories will wear and require occasional replacement. Maintenance of a rain barrel generally involves: removing accumulated debris from the inlet and storage container on a routine basis; and replacement of ancillary parts on an as-needed basis. A summary table of standard inspection and maintenance indicators is provided within this Fact Sheet. If the system includes a pump, maintenance of the pump shall be based on the manufacturer's recommended maintenance plan.

**Non-Standard Maintenance or BMP Failure.** If any of the following scenarios are observed, the BMP is not performing as intended to protect downstream waterways from pollution and/or erosion. Corrective maintenance, increased inspection and maintenance, BMP replacement, or a different BMP type will be required.

- The inlet is found to be obstructed at every inspection such that storm water bypasses the rain barrel. The rain barrel is not functioning properly if it is not capturing storm water. This would require addition of ancillary features to protect the inlet, such as screens on roof gutters.
- The rain barrel is not drained between storm events. If the rain barrel is not drained between storm events, the storage volume will be diminished and the rain barrel will not capture the required volume of storm water from subsequent storms. This would require implementation of practices onsite to drain and use the stored water, or a different BMP if onsite use cannot be reliably sustained.

**Other Special Considerations.** Site design BMPs, such as rain barrels, installed within a new development or redevelopment project are components of an overall storm water management strategy for the project. The presence of site design BMPs within a project is usually a factor in the determination of the amount of runoff to be managed with structural BMPs (i.e., the amount of runoff expected to reach downstream retention or biofiltration basins that process storm water runoff from the project as a whole). When site design BMPs are not maintained or are removed, this can lead to clogging or failure of downstream structural BMPs due to greater delivery of runoff and pollutants than intended for the structural BMP. Therefore, the City Engineer may require confirmation of maintenance of site design BMPs as part of their structural BMP maintenance documentation requirements. Site design BMPs that have been installed as part of the project should not be removed, nor should they be bypassed by re-routing roof drains or re-grading surfaces within the project. If changes are necessary, consult the City Engineer to determine requirements.

**Summary of Standard Inspection and Maintenance**

The property owner is responsible to ensure inspection, operation and maintenance of permanent BMPs on their property unless responsibility has been formally transferred to an agency, community facilities district, homeowners association, property owners association, or other special district.

Maintenance frequencies listed in this table are average/typical frequencies. Actual maintenance needs are site-specific, and maintenance may be required more frequently. Maintenance must be performed whenever needed, based on maintenance indicators presented in this table. The BMP owner is responsible for conducting regular inspections to see when maintenance is needed based on the maintenance indicators. During the first year of operation of a structural BMP, inspection is recommended at least once prior to August 31 and then monthly from September through May. Inspection during a storm event is also recommended. After the initial period of frequent inspections, the minimum inspection and maintenance frequency can be determined based on the results of the first year inspections.

Threshold/Indicator	Maintenance Action	Typical Maintenance Frequency
Accumulation of debris at the inlet	Remove and properly dispose of accumulated materials.	<ul style="list-style-type: none"> <li>• Inspect monthly and after every 0.5-inch or larger storm event.</li> <li>• Remove any accumulated materials found at each inspection.</li> </ul>
Outlet blocked	Clear blockage.	<ul style="list-style-type: none"> <li>• Inspect monthly and after every 0.5-inch or larger storm event.</li> <li>• Remove any accumulated materials found at each inspection.</li> </ul>
Accumulation of debris in the storage container	Remove and properly dispose of accumulated materials.	<ul style="list-style-type: none"> <li>• Inspect twice per year.</li> <li>• Maintain when needed.</li> </ul>
Leaks or other damage to storage container	Repair or replace as applicable.	<ul style="list-style-type: none"> <li>• Inspect twice per year.</li> <li>• Maintain when needed.</li> </ul>

Threshold/Indicator	Maintenance Action	Typical Maintenance Frequency
Standing water in storage container between storm events outside of normal use timeframe for the stored water. Normal use timeframe is 36 to 96 hours following a storm event.	Use the water as intended, or disperse to landscaping.	<ul style="list-style-type: none"> <li>• Inspect monthly and after every 0.5-inch or larger storm event. If standing water is observed, increase inspection frequency to after every 0.1-inch or larger storm event.</li> <li>• Maintain when needed.</li> </ul>
Presence of mosquitos/larvae  For images of egg rafts, larva, pupa, and adult mosquitos, see <a href="http://www.mosquito.org/biology">http://www.mosquito.org/biology</a>	If mosquitos/larvae are observed: first, immediately remove any standing water by using the water as intended for irrigation or alternative grey water, or by dispersing to landscaping; second, check outlet for blockage and clear blockage if applicable to restore drainage; third, install barriers such as screens that prevent mosquito access to the storage container.	<ul style="list-style-type: none"> <li>• Inspect monthly and after every 0.5-inch or larger storm event. If mosquitos are observed, increase inspection frequency to after every 0.1-inch or larger storm event.</li> <li>• Maintain when needed.</li> </ul>
Leaks or other damage to ancillary parts including valves, piping, screens, level indicators, and other accessories	Repair or replace as applicable.	<ul style="list-style-type: none"> <li>• Inspect twice per year.</li> <li>• Maintain when needed.</li> </ul>
Rain barrel leaning or unstable, damage to roof, supports, anchors, or foundation	Make repairs as appropriate to correct the problem and stabilize the system.	<ul style="list-style-type: none"> <li>• Inspect twice per year.</li> <li>• Maintain when needed.</li> </ul>

## E.11 SD-F Amended Soils



Photo Credit: Orange County Technical Guidance Document

---

### MS4 Permit Category

---

Site Design

---

### Manual Category

---

Site Design

---

### Applicable Performance Standard

---

Site Design

---

### Primary Benefits

---

Volume Reduction

Peak Flow Attenuation

---

### Description

Amended soils are soils whose physical, chemical, and biological characteristics have been altered from the natural condition to promote beneficial storm water characteristics. Amended soils shall be used as part of SD-B Impervious Area Dispersion, where applicable. Typical storm water management benefits associated with amended soils include:

- **Improved hydrologic characteristics**—amended soils can promote infiltration, decrease runoff rates and volumes, and more effectively filter pollutants from storm water runoff
- **Improved vegetation health**—amended soils provide greater moisture retention, and altered chemical and biological characteristics that can result in healthier plant growth, reduced irrigation demands, and reduced need for fertilization and maintenance
- **Reduced erosion**—amended soils produce healthier plant growth and reduced runoff which results in reduced soil erosion

Not all amended soils have the same storm water benefits, the soil amendment used should be suited for the design purpose and design period of the amended area.

### Design Adaptations for Project Goals

Varying categories of soil amendments have different benefits and applications. Mulch is a soil amendment that is added at grade, rather than mixed into the soil. Mulch reduces evaporation and improves retention. Shavings and compost are common soil amendments that improve biological and chemical properties of the soil. Sand can be used as an amendment to improve the drainage rates of amended soils. Native soil samples may need to be analyzed by a lab to determine the specific soil amendments needed to achieve the desired infiltration, retention, and/or filtration rates.

**Design Criteria and Considerations**

Soil amendments must meet the following design criteria and considerations. Deviations from the below criteria may be approved at the discretion of the City Engineer if appropriate:

<i>Siting and Design</i>	<i>Intent/Rationale</i>
<input type="checkbox"/> When mulch is used as an amendment, it is applied at grade over all planting areas to a depth of 3".	Mulch should be applied on top and not mixed into underlying soils
<input type="checkbox"/> When shavings or compost is used as an amendment, it is rototilled into the native soil to a minimum depth of 6" (12 inches preferred).	If soil is not completely mixed the overall benefit will be reduced.
<input type="checkbox"/> Compost meets the criteria in Appendix F.3.1.2	If poor quality compost is used, it will have negative impact to water quality.
<input type="checkbox"/> Soil amendments are free of stones, stumps, roots, glass, plastic, metal, and other deleterious materials.	Large debris in amended soils can cause localized erosion. Trash/harmful materials can result in personal injury or contamination.
<input type="checkbox"/> Mixing of soils are done prior to planting	Soil mixing before planting results in a more homogeneous mixing and will reduce the stress on plants.
<input type="checkbox"/> Care is taken around existing trees and shrubs to prevent root damage during construction and soil amendment application.	Preservation of existing established vegetation is an important part of site design and erosion control.
<input type="checkbox"/> Soil amendments are applied at the end of construction	Soil amendments applied too soon in the construction process may become over compacted reducing effectiveness.
<input type="checkbox"/> Soil amendments are compatible with planned vegetation	The soil amendments impact the pH and salinity of the soil. Some plants have sensitive pH and/or salinity tolerance ranges.

**Conceptual Design and Sizing Approach for Site Design**

- When soil amendments are used a runoff factor of 0.1 can be used for DCV calculation for the amended area.
- Amended soils should be used as part of SD-B Impervious Area Dispersion, and to increase the retention volume in other BMPs.



**Maintenance**

---

Annual maintenance may be required to determine reapplication requirements of amended soils. Amended soils should be regularly inspected for signs of compaction, waterlogging, and unhealthy vegetation.

## E.12 HU-1 Cistern

**MS4 Permit Category**

Retention

**Manual Category**

Harvest and Use

**Applicable Performance Standards**

Pollutant Control

Flow Control

**Primary Benefits**

Volume Reduction

Peak Flow Attenuation

*Photo Credit: Water Environment Research Foundation: WERF.org*

**Description**

Cisterns are containers that can capture rooftop runoff and store it for future use. With controlled timing and volume release, the captured rainwater can be used for irrigation or alternative grey water between storm events, thereby reducing runoff volumes and associated pollutants to downstream water bodies. Cisterns are larger systems (generally >100 gallons) that can be self-contained aboveground or below ground systems. Treatment can be achieved when cisterns are used as part of a treatment train along with other BMPs that use captured flows in applications that do not result in discharges into the storm drain system. Rooftops are the ideal tributary areas for cisterns.

Typical cistern components include:

- Storage container, barrel or tank for holding captured flows
- Inlet and associated valves and piping
- Outlet and associated valves and piping
- Overflow outlet
- Optional pump

- Optional first flush diverters
- Optional roof, supports, foundation, level indicator, and other accessories

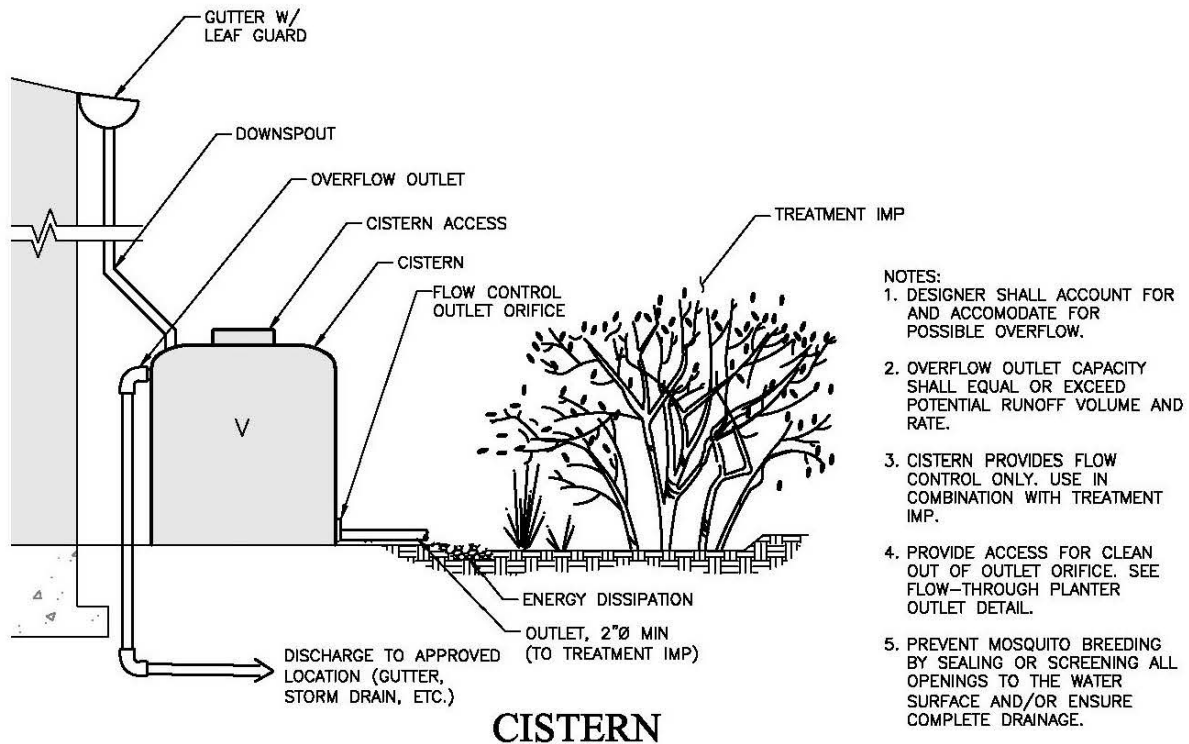

Source: City of San Diego Storm Water Standards

**Design Adaptations for Project Goals**

**Site design BMP to reduce effective impervious area and DCV.** Cisterns can be used as a site design feature to reduce the effective impervious area of the site by removing roof runoff from the site discharge. This can reduce the DCV and flow control requirements for the site.

**Harvest and use for storm water pollutant control.** Typical uses for captured flows include irrigation, toilet flushing, cooling system makeup, and vehicle and equipment washing.

**Integrated storm water flow control and pollutant control configuration.** Cisterns provide flow control in the form of volume reduction and/or peak flow attenuation and storm water treatment through elimination of discharges of pollutants. Additional flow control can be achieved by sizing the

cistern to include additional detention storage and/or real-time automated flow release controls.

**Design Criteria and Considerations**

Cisterns must meet the following design criteria. Deviations from the below criteria may be approved at the discretion of the City Engineer if it is determined to be appropriate:

<i>Siting and Design</i>	<i>Intent/Rationale</i>
<input type="checkbox"/> Cisterns are sized to detain the full DCV of contributing area and empty within 36 hours.	<p>Draining the cistern makes the storage volume available to capture the next storm.</p> <p>The applicant has an option to use a different drawdown time up to 96 hours if the volume of the facility is adjusted using the percent capture method in Appendix B.4.2.</p>
<input type="checkbox"/> Cisterns are fitted with a flow control device such as an orifice or a valve to limit outflow in accordance with drawdown time requirements.	<p>Flow control provides flow attenuation benefits and limits cistern discharge to downstream facilities during storm events.</p>
<input type="checkbox"/> Cisterns are designed to drain completely, leaving no standing water, and all entry points are fitted with traps or screens, or sealed.	<p>Complete drainage and restricted entry prevents mosquito habitat.</p>
<input type="checkbox"/> Leaf guards and/or screens are provided to prevent debris from accumulating in the cistern.	<p>Leaves and organic debris can clog the outlet of the cistern.</p>
<input type="checkbox"/> Access is provided for maintenance and the cistern outlets are accessible and designed to allow easy cleaning.	<p>Properly functioning outlets are needed to maintain proper flow control in accordance with drawdown time requirements.</p>
<input type="checkbox"/> Cisterns must be designed and sited such that overflow will be conveyed safely overland to the storm drain system or discharge point.	<p>Safe overflow conveyance prevents flooding and damage of property.</p>

**Conceptual Design and Sizing Approach for Site Design and Storm Water Pollutant Control**

1. Calculate the DCV for site design per Appendix B.
2. Determine the locations on the site where cisterns can be located to capture and detain the DCV from roof areas without subsequent discharge to the storm drain system. Cisterns are

best located in close proximity to building and other roofed structures to minimize piping. Cisterns can also be used as part of a treatment train upstream by increasing pollutant control through delayed runoff to infiltration BMPs such as bioretention without underdrain facilities.

3. Use the sizing worksheet in Appendix B.3 to determine if full or partial capture of the DCV is achievable.
4. The remaining DCV to be treated should be calculated for use in sizing downstream BMP(s).

### **Conceptual Design and Sizing Approach when Storm Water Flow Control is Applicable**

Control of flow rates and/or duration will typically require significant cistern volumes, and therefore the following steps should be taken prior to determination of site design and storm water pollutant control. Pre-development and allowable post-project flow rates and durations should be determined as discussed in Chapter 6 of the manual.

1. Verify that cistern siting and design criteria have been met. Design for flow control can be achieved using various design configurations, shapes, and quantities of cisterns.
2. Iteratively determine the cistern storage volume required to provide detention storage to reduce flow rates and durations to allowable limits. Flow rates and durations can be controlled from detention storage by altering outlet structure orifice size(s) and/or water control valve operation.
3. Verify that the cistern is drawdown within 36 hours. The drawdown time can be estimated by dividing the storage volume by the rate of use of harvested water.
4. If the cistern cannot fully provide the flow rate and duration control required by this manual, a downstream structure with additional storage volume or infiltration capacity such as a biofiltration can be used to provide remaining flow control.

### **Maintenance Overview**

**Normal Expected Maintenance.** Cisterns can be expected to accumulate sediment and debris that is small enough to pass through the inlet into the storage container. Larger debris such as leaves or trash may accumulate at the inlet. While the storage container is generally a permanent structure, ancillary parts including valves, piping, screens, level indicators, and other accessories will wear and require occasional replacement. Maintenance of a cistern generally involves: removing accumulated sediment and debris from the inlet and storage container on a routine basis; and replacement of ancillary parts on an as-needed basis. A summary table of standard inspection and maintenance indicators is provided within this Fact Sheet. If the system as a whole includes a pump or other electrical equipment, maintenance of the equipment shall be based on the manufacturer's recommended maintenance plan.

**Non-Standard Maintenance or BMP Failure.** If any of the following scenarios are observed, the BMP is not performing as intended to protect downstream waterways from pollution and/or erosion. Corrective maintenance, increased inspection and maintenance, BMP replacement, or a different BMP type will be required.

- The inlet is found to be obstructed at every inspection such that storm water bypasses the cistern. The cistern is not functioning properly if it is not capturing storm water. This would require addition of ancillary features to protect the inlet, or pretreatment measures within the watershed draining to the cistern to intercept larger debris, such as screens on roof gutters, or drainage inserts within catch basins. Increase the frequency of inspection until the issue is resolved.
- Accumulation of sediment within one year is greater than 25% of the volume of the cistern. This means the sediment load from the tributary drainage area has diminished the storage volume of the cistern and the cistern will not capture the required volume of storm water. This would require pretreatment measures within the tributary area draining to the cistern to intercept sediment.
- The cistern is not drained between storm events. If the cistern is not drained between storm events, the storage volume will be diminished and the cistern will not capture the required volume of storm water from subsequent storms. This would require implementation of practices onsite to drain and use the stored water, or a different BMP if onsite use cannot be reliably sustained.

**Summary of Standard Inspection and Maintenance**

The property owner is responsible to ensure inspection, operation and maintenance of permanent BMPs on their property unless responsibility has been formally transferred to an agency, community facilities district, homeowners association, property owners association, or other special district.

Maintenance frequencies listed in this table are average/typical frequencies. Actual maintenance needs are site-specific, and maintenance may be required more frequently. Maintenance must be performed whenever needed, based on maintenance indicators presented in this table. The BMP owner is responsible for conducting regular inspections to see when maintenance is needed based on the maintenance indicators. During the first year of operation of a structural BMP, inspection is recommended at least once prior to August 31 and then monthly from September through May. Inspection during a storm event is also recommended. After the initial period of frequent inspections, the minimum inspection and maintenance frequency can be determined based on the results of the first year inspections.

Threshold/Indicator	Maintenance Action	Typical Inspection and Maintenance Frequency
Accumulation of sediment, litter, or debris at the inlet	Remove and properly dispose of accumulated materials.	<ul style="list-style-type: none"> <li>• Inspect monthly and after every 0.5-inch or larger storm event.</li> <li>• Remove any accumulated materials found at each inspection.</li> </ul>
Outlet blocked	Clear blockage.	<ul style="list-style-type: none"> <li>• Inspect monthly and after every 0.5-inch or larger storm event.</li> <li>• Remove any accumulated materials found at each inspection.</li> </ul>

Threshold/Indicator	Maintenance Action	Typical Inspection and Maintenance Frequency
<p>Accumulation of sediment, litter, or debris in the storage container</p>	<p>Remove and properly dispose of accumulated materials.</p>	<ul style="list-style-type: none"> <li>• Inspect monthly. If the BMP is 25% full* or more in one month, increase inspection frequency to monthly plus after every 0.1-inch or larger storm event.</li> <li>• Remove materials annually (minimum), or more frequently when BMP is 25% full* (or at manufacturer threshold if manufacturer threshold is less than 25% full*) in less than one year, or if accumulation blocks outlet</li> </ul>
<p>Standing water in storage container between storm events outside of normal use timeframe for the stored water. Normal use timeframe is 36 to 96 hours following a storm event depending on the purpose and design of the cistern.</p>	<p>Use the water as intended, or disperse to landscaping.</p> <p>Implement practices onsite to drain and use the stored water.</p> <p>Contact the City Engineer to determine a solution if onsite use cannot be reliably sustained.</p>	<ul style="list-style-type: none"> <li>• Inspect monthly and after every 0.5-inch or larger storm event. If standing water is observed, increase inspection frequency to after every 0.1-inch or larger storm event.</li> <li>• Maintain when needed.</li> </ul>



Threshold/Indicator	Maintenance Action	Typical Inspection and Maintenance Frequency
<p>Presence of mosquitos/larvae</p> <p>For images of egg rafts, larva, pupa, and adult mosquitos, see <a href="http://www.mosquito.org/biology">http://www.mosquito.org/biology</a></p>	<p>If mosquitos/larvae are observed: first, immediately remove any standing water by using the water as intended for irrigation or alternative grey water, or by dispersing to landscaping; second, check cistern outlet for blockage and clear blockage if applicable to restore drainage; third, install barriers such as screens that prevent mosquito access to the storage container.</p>	<ul style="list-style-type: none"> <li>• Inspect monthly and after every 0.5-inch or larger storm event. If mosquitos are observed, increase inspection frequency to after every 0.1-inch or larger storm event.</li> <li>• Maintain when needed.</li> </ul>
<p>Leaks or other damage to ancillary parts including valves, piping, screens, level indicators, and other accessories</p>	<p>Repair or replace as applicable.</p>	<ul style="list-style-type: none"> <li>• Inspect twice per year.</li> <li>• Maintain when needed.</li> </ul>
<p>Leaks or other damage to storage container</p>	<p>Repair or replace as applicable.</p>	<ul style="list-style-type: none"> <li>• Inspect twice per year.</li> <li>• Maintain when needed.</li> </ul>
<p>Cistern leaning or unstable, damage to roof, supports, anchors, or foundation</p>	<p>Make repairs as appropriate to correct the problem and stabilize the system.</p>	<ul style="list-style-type: none"> <li>• Inspect twice per year.</li> <li>• Maintain when needed.</li> </ul>

## E.13 INF-1 Infiltration Basin



Photo Credit: <http://www.stormwaterpartners.com/facilities/basin.html>

---

**MS4 Permit Category**

---

Retention

---

**Manual Category**

---

Infiltration

---

**Applicable Performance Standard**

---

Pollutant Control

Flow Control

---

**Primary Benefits**

---

Volume Reduction

Peak Flow Attenuation

**Description**

An infiltration basin typically consists of an earthen basin with a flat bottom constructed in naturally pervious soils. An infiltration basin retains storm water and allows it to evaporate and/or percolate into the underlying soils. The bottom of an infiltration basin is typically vegetated with native grasses or turf grass; however other types of vegetation can be used if they can survive periodic inundation and long inter-event dry periods. Treatment is achieved primarily through infiltration, filtration, sedimentation, biochemical processes and plant uptake. Infiltration basins can be constructed as linear **trenches** or as **underground infiltration galleries**.

Typical infiltration basin components include:

- Inflow distribution mechanisms (e.g., perimeter flow spreader or filter strips)
- Energy dissipation mechanism for concentrated inflows (e.g., splash blocks or riprap)
- Forebay to provide pretreatment surface ponding for captured flows, other pretreatment mechanisms may be used if they meet the requirements included in Appendix B.6.
- Vegetation selected based on basin use, climate, and ponding depth
- Uncompacted native soils at the bottom of the facility
- Overflow structure

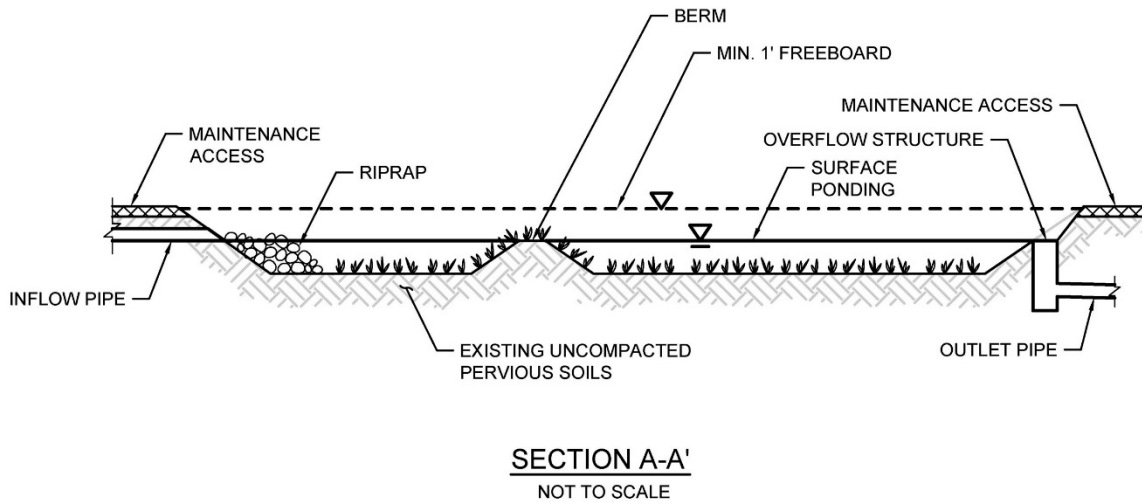
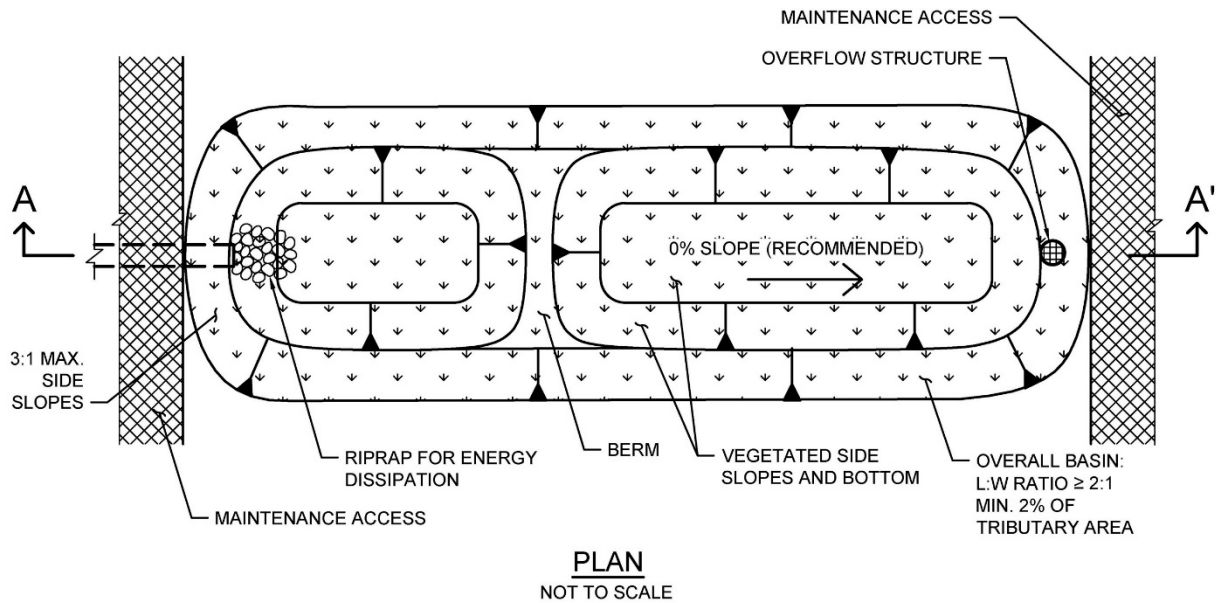

Typical plan and section view of an Infiltration BMP

**Design Adaptations for Project Goals**

**Full infiltration BMP for storm water pollutant control.** Infiltration basins can be used as a pollutant control BMP, designed to infiltrate runoff from direct rainfall as well as runoff from adjacent areas that are tributary to the BMP. Infiltration basins must be designed with an infiltration storage volume (a function of the surface ponding volume) equal to the full DCV and able to meet drawdown

time limitations.

**Integrated storm water flow control and pollutant control configuration.** Infiltration basins can also be designed for flow rate and duration control by providing additional infiltration storage through increasing the surface ponding volume.

**Recommended Siting Criteria**

<i>Siting Criteria</i>	<i>Intent/Rationale</i>
<input type="checkbox"/> Placement observes geotechnical recommendations regarding potential hazards (e.g., slope stability, landslides, liquefaction zones) and setbacks (e.g., slopes, foundations, utilities).	Must not negatively impact existing site geotechnical concerns.
<input type="checkbox"/> Selection and design of basin is based on infiltration feasibility criteria and appropriate design infiltration rate (See Appendix C and D).	Must operate as a full infiltration design and must be supported by drainage area and in-situ infiltration rate feasibility findings.

**Recommended BMP Component Dimensions**

<i>BMP Component</i>	<i>Dimension</i>	<i>Intent/Rationale</i>
Freeboard	≥ 12 inches	Freeboard minimizes risk of uncontrolled surface discharge.
Ponding Area Side Slopes	3H:1V or shallower	Gentler side slopes are safer, less prone to erosion, able to establish vegetation more quickly and easier to maintain.
Settling Forebay Volume	≥ 25% of facility volume	A forebay to trap sediment can decrease frequency of required maintenance. Other pretreatment devices may be used in accordance with Appendix B.6.

**Design Criteria and Considerations**

Infiltration basins must meet the following design criteria. Deviations from the below criteria may be approved at the discretion of the City Engineer if it is determined to be appropriate:

<i>Design Criteria</i>	<i>Intent/Rationale</i>
<input type="checkbox"/> Finish grade of the facility is $\leq 2\%$ (0% recommended).	Flatter surfaces reduce erosion and channelization with the facility.
<input type="checkbox"/> Infiltration of surface ponding is limited to a 36-hour drawdown time.	<p>Prolonged surface ponding reduce volume available to capture subsequent storms.</p> <p>The applicant has an option to use a different drawdown time up to 96 hours if the volume of the facility is adjusted using the percent capture method in Appendix B.4.2.</p>
<b><i>Inflow and Overflow Structures</i></b>	
<input type="checkbox"/> Inflow and outflow structures are accessible by required equipment (e.g., vactor truck) for inspection and maintenance.	Maintenance will prevent clogging and ensure proper operation of the flow control structures.
<input type="checkbox"/> Inflow velocities are limited to 3 ft/s or less or use energy dissipation methods (e.g., riprap, level spreader) for concentrated inflows.	High inflow velocities can cause erosion, scour and/or channeling.
<input type="checkbox"/> Overflow is safely conveyed to a downstream storm drain system or discharge point. Size overflow structure to pass 100-year peak flow for on-line basins and water quality peak flow for off-line basins.	Planning for overflow lessens the risk of property damage due to flooding.

**Conceptual Design and Sizing Approach for Storm Water Pollutant Control**

To design infiltration basins for storm water pollutant control only (no flow control required), the following steps should be taken:

1. Verify that siting and design criteria have been met, including placement and basin area requirements, forebay volume (not included in infiltration footprint for sizing), and maximum slopes for basin sides and bottom.
2. Calculate the DCV per Appendix B based on expected site design runoff for tributary areas.
3. Use the sizing worksheet (Appendix B.4) to determine if full infiltration of the DCV is achievable based on the infiltration storage volume calculated from the surface ponding area

and depth for a maximum 36-hour drawdown time. The drawdown time can be estimated by dividing the average depth of the basin by the design infiltration rate. Appendix D provides guidance on evaluating a site's infiltration rate.

### **Conceptual Design and Sizing Approach for Storm Water Pollutant Treatment and Flow Control**

Control of flow rates and/or durations will typically require significant surface ponding volume, and therefore the following steps should be taken prior to determination of storm water pollutant control design. Pre-development and allowable post-project flow rates and durations should be determined as discussed in Chapter 6 of the manual.

1. Verify that siting and design criteria have been met, including placement and basin area requirements, forebay volume (not included in infiltration footprint for sizing), and maximum slopes for basin sides and bottom.
2. Iteratively determine the surface ponding required to provide infiltration storage to reduce flow rates and durations to allowable limits while adhering to the maximum 36-hour drawdown time. Flow rates and durations can be controlled using flow splitters that route the appropriate inflow amounts to the infiltration basin and bypass excess flows to the downstream storm drain system or discharge point.
3. If an infiltration basin cannot fully provide the flow rate and duration control required by this manual, an upstream or downstream structure with appropriate storage volume such as an underground vault can be used to provide additional control.
4. After the infiltration basin has been designed to meet flow control requirements, calculations must be completed to verify if storm water pollutant control requirements to treat the DCV have been met.

### **Maintenance Overview**

**Normal Expected Maintenance.** Infiltration basins require routine maintenance to: remove accumulated materials such as sediment, trash or debris from the forebay and the basin; maintain vegetation health if the BMP includes vegetation; and maintain integrity of side slopes, inlets, energy dissipators, and outlets. A summary table of standard inspection and maintenance indicators is provided within this Fact Sheet.

**Non-Standard Maintenance or BMP Failure.** If any of the following scenarios are observed, the BMP is not performing as intended to protect downstream waterways from pollution and/or erosion. Corrective maintenance, increased inspection and maintenance, BMP replacement, or a different BMP type will be required.

- The BMP is not drained between storm events. Surface ponding longer than approximately 24 hours following a storm event may be detrimental to vegetation health, and surface or

subsurface ponding longer than approximately 96 hours following a storm event poses a risk of vector (mosquito) breeding. Poor drainage can result from clogging of the underlying native soils, or clogging of covers applied at the basin surface such as topsoil, mulch, or rock layer. The specific cause of the drainage issue must be determined and corrected. For surface-level basins (i.e., not underground infiltration galleries), surface cover materials can be removed and replaced, and/or native soils can be scarified or tilled to help reestablish infiltration. If it is determined that the underlying native soils have been compacted or do not have the infiltration capacity expected, or if the infiltration surface area is not accessible (e.g., an underground infiltration gallery) the City Engineer shall be contacted prior to any additional repairs or reconstruction.

- Sediment, trash, or debris accumulation has filled the forebay or other pretreatment device within one month, or if no forebay or other pretreatment device is present, has filled greater than 25% of the surface ponding volume within one maintenance cycle. This means the load from the tributary drainage area is too high, reducing BMP function or clogging the BMP. This would require adding a forebay or other pretreatment measures within the tributary area draining to the BMP to intercept the materials if no pretreatment component is present, or increased maintenance frequency for an existing forebay or other pretreatment device. Pretreatment components, especially for sediment, will extend the life of the infiltration basin.
- Erosion due to concentrated storm water runoff flow that is not readily corrected by adding erosion control blankets, adding stone at flow entry points, or minor re-grading to restore proper drainage according to the original plan. If the issue is not corrected by restoring the BMP to the original plan and grade, the City Engineer shall be contacted prior to any additional repairs or reconstruction.

**Other Special Considerations.** If the infiltration basin is vegetated: Vegetated structural BMPs that are constructed in the vicinity of, or connected to, an existing jurisdictional water or wetland could inadvertently result in creation of expanded waters or wetlands. As such, vegetated structural BMPs have the potential to come under the jurisdiction of the United States Army Corps of Engineers, SDRWQCB, California Department of Fish and Wildlife, or the United States Fish and Wildlife Service. This could result in the need for specific resource agency permits and costly mitigation to perform maintenance of the structural BMP. Along with proper placement of a structural BMP, routine maintenance is key to preventing this scenario.

**Sediment Loading:** Consider the effects of BMP design and tributary area land uses on the clogging potential of the BMP. Complete the sediment loading analysis included in Appendix E.27.

**Summary of Standard Inspection and Maintenance**

The property owner is responsible to ensure inspection, operation and maintenance of permanent BMPs on their property unless responsibility has been formally transferred to an agency, community facilities district, homeowners association, property owners association, or other special district.

Maintenance frequencies listed in this table are average/typical frequencies. Actual maintenance needs are site-specific, and maintenance may be required more frequently. Maintenance must be performed whenever needed, based on maintenance indicators presented in this table. The BMP owner is responsible for conducting regular inspections to see when maintenance is needed based on the maintenance indicators. During the first year of operation of a structural BMP, inspection is recommended at least once prior to August 31 and then monthly from September through May. Inspection during a storm event is also recommended. After the initial period of frequent inspections, the minimum inspection and maintenance frequency can be determined based on the results of the first year inspections.

Threshold/Indicator	Maintenance Action	Typical Maintenance Frequency
Accumulation of sediment, litter, or debris in forebay and/or basin	Remove and properly dispose of accumulated materials, (without damage to vegetation when applicable).	<ul style="list-style-type: none"> <li>• Inspect monthly. If the forebay is 25% full* or more in one month, increase inspection frequency to monthly plus after every 0.1-inch or larger storm event.</li> <li>• Remove any accumulated materials found within the infiltration area at each inspection.</li> <li>• When the BMP includes a forebay, materials must be removed from the forebay when the forebay is 25% full*, or if accumulation within the forebay blocks flow to the infiltration area.</li> </ul>
Obstructed inlet or outlet structure	Clear blockage.	<ul style="list-style-type: none"> <li>• Inspect monthly and after every 0.5-inch or larger storm event.</li> <li>• Remove any accumulated materials found at each inspection.</li> </ul>



Threshold/Indicator	Maintenance Action	Typical Maintenance Frequency
Poor vegetation establishment (when the BMP includes vegetated surface by design)	Re-seed, re-plant, or re-establish vegetation per original plans.	<ul style="list-style-type: none"> <li>• Inspect monthly.</li> <li>• Maintain when needed.</li> </ul>
Dead or diseased vegetation (when the BMP includes vegetated surface by design)	Remove dead or diseased vegetation, re-seed, re-plant, or re-establish vegetation per original plans.	<ul style="list-style-type: none"> <li>• Inspect monthly.</li> <li>• Maintain when needed.</li> </ul>
Overgrown vegetation (when the BMP includes vegetated surface by design)	Mow or trim as appropriate.	<ul style="list-style-type: none"> <li>• Inspect monthly.</li> <li>• Maintain when needed.</li> </ul>
Erosion due to concentrated irrigation flow	Repair/re-seed/re-plant eroded areas and adjust the irrigation system.	<ul style="list-style-type: none"> <li>• Inspect monthly.</li> <li>• Maintain when needed.</li> </ul>
Erosion due to concentrated storm water runoff flow	Repair/re-seed/re-plant eroded areas, and make appropriate corrective measures such as adding erosion control blankets, adding stone at flow entry points, or minor re-grading to restore proper drainage according to the original plan. If the issue is not corrected by restoring the BMP to the original plan and grade, the City Engineer shall be contacted prior to any additional repairs or reconstruction.	<ul style="list-style-type: none"> <li>• Inspect after every 0.5-inch or larger storm event. If erosion due to storm water flow has been observed, increase inspection frequency to after every 0.1-inch or larger storm event.</li> <li>• Maintain when needed. If the issue is not corrected by restoring the BMP to the original plan and grade, the City Engineer shall be contacted prior to any additional repairs or reconstruction.</li> </ul>

Threshold/Indicator	Maintenance Action	Typical Maintenance Frequency
<p>Standing water in infiltration basin without subsurface infiltration gallery for longer than 24-96 hours following a storm event</p>	<p>Make appropriate corrective measures such as adjusting irrigation system, removing obstructions of debris or invasive vegetation, or removing/replacing clogged or compacted surface treatments and/or scarifying or tilling native soils. Always remove deposited sediments before scarification, and use a hand-guided rotary tiller. If it is determined that the underlying native soils have been compacted or do not have the infiltration capacity expected, the City Engineer shall be contacted prior to any additional repairs or reconstruction.</p>	<ul style="list-style-type: none"> <li>• Inspect monthly and after every 0.5-inch or larger storm event. If standing water is observed, increase inspection frequency to after every 0.1-inch or larger storm event.</li> <li>• Maintain when needed.</li> </ul>
<p>Standing water in subsurface infiltration gallery for longer than 24-96 hours following a storm event</p>	<p>This condition requires investigation of why infiltration is not occurring. If feasible, corrective action shall be taken to restore infiltration (e.g., flush fine sediment or remove and replace clogged soils). BMP may require retrofit if infiltration cannot be restored. The City Engineer shall be contacted prior to any repairs or reconstruction.</p>	<ul style="list-style-type: none"> <li>• Inspect monthly and after every 0.5-inch or larger storm event. If standing water is observed, increase inspection frequency to after every 0.1-inch or larger storm event.</li> <li>• Maintain when needed.</li> </ul>

Threshold/Indicator	Maintenance Action	Typical Maintenance Frequency
<p>Presence of mosquitos/larvae</p> <p>For images of egg rafts, larva, pupa, and adult mosquitos, see <a href="http://www.mosquito.org/biology">http://www.mosquito.org/biology</a></p>	<p>If mosquitos/larvae are observed: first, immediately remove any standing water by dispersing to nearby landscaping; second, make corrective measures as applicable to restore BMP drainage to prevent standing water. For subsurface infiltration galleries, ensure access covers are tight fitting, with gaps or holes no greater than 1/16 inch, and/or install barriers such as inserts or screens that prevent mosquito access to the subsurface storage.</p> <p>If mosquitos persist following corrective measures to remove standing water, or if the BMP design does not meet the 96-hour drawdown criteria because the underlying native soils have been compacted or do not have the infiltration capacity expected, the City Engineer shall be contacted to determine a solution. A different BMP type, or a Vector Management Plan prepared with concurrence from the County of San Diego Department of Environmental Health, may be required.</p>	<ul style="list-style-type: none"> <li>• Inspect monthly and after every 0.5-inch or larger storm event. If mosquitos are observed, increase inspection frequency to after every 0.1-inch or larger storm event.</li> <li>• Maintain when needed</li> </ul>
<p>Damage to structural components such as weirs, inlet or outlet structures</p>	<p>Repair or replace as applicable.</p>	<ul style="list-style-type: none"> <li>• Inspect annually.</li> <li>• Maintain when needed.</li> </ul>

“25% full” is defined as ¼ of the depth from the design bottom elevation to the crest of the outflow structure (e.g., if the height to the outflow opening is 12 inches from the bottom elevation, then the materials must be removed when there is 3 inches of accumulation – this should be marked on the outflow structure).

## E.14 INF-2 Bioretention

**MS4 Permit Category**

Retention

**Manual Category**

Infiltration

**Applicable Performance Standard**Pollutant Control  
Flow Control**Primary Benefits**Volume Reduction  
Treatment  
Peak Flow Attenuation

*Photo Credit: Ventura County Technical Guidance Document*

**Description**

Bioretention (bioretention without underdrain) facilities are vegetated surface water systems that filter water through vegetation and soil, or engineered media prior to infiltrating into native soils. These facilities are designed to infiltrate the full DCV. Bioretention facilities are commonly incorporated into the site within parking lot landscaping, along roadsides, and in open spaces. They can be constructed inground or partially aboveground, such as planter boxes with open bottoms (no impermeable liner at the bottom) to allow infiltration. Treatment is achieved through filtration, sedimentation, sorption, infiltration, biochemical processes and plant uptake.

Typical bioretention without underdrain components include:

- Inflow distribution mechanisms (e.g, perimeter flow spreader or filter strips)
- Energy dissipation mechanism for concentrated inflows (e.g., splash blocks or riprap)
- Shallow surface ponding for captured flows
- Side slope and basin bottom vegetation selected based on expected climate and ponding depth
- Non-floating mulch layer (optional)
- Media layer (planting mix or engineered media) capable of supporting vegetation growth
- Filter course layer consisting of aggregate to prevent the migration of fines into uncompacted

native soils or the optional aggregate storage layer

- Optional aggregate storage layer for additional infiltration storage
- Uncompacted native soils at the bottom of the facility
- Overflow structure

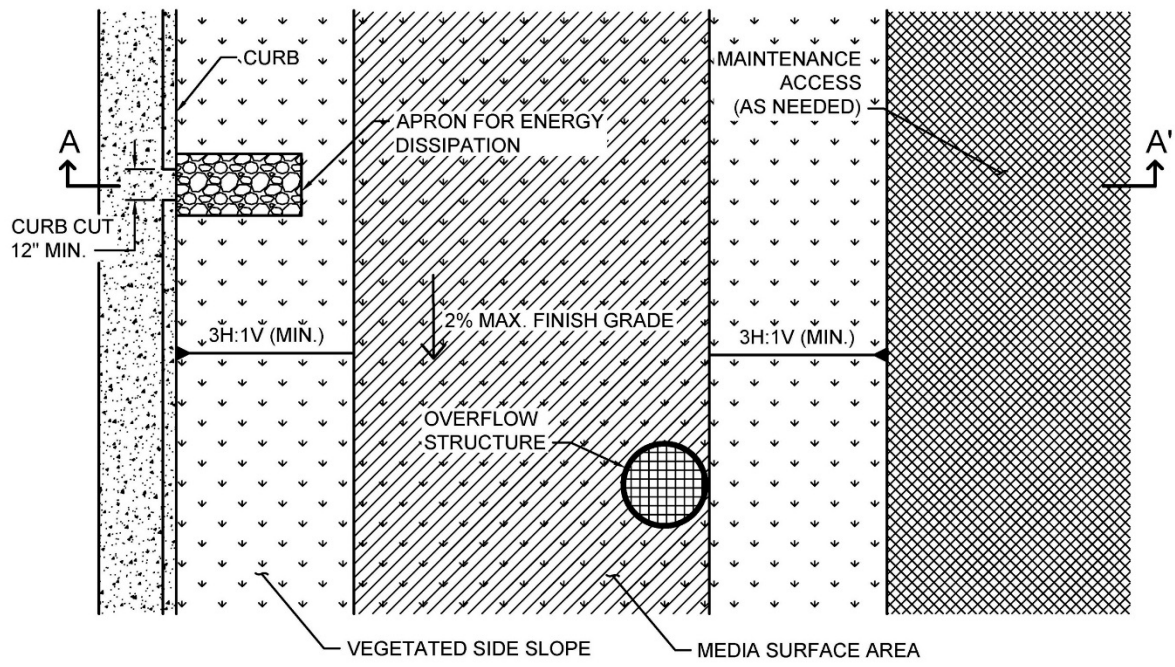

**PLAN**  
NOT TO SCALE

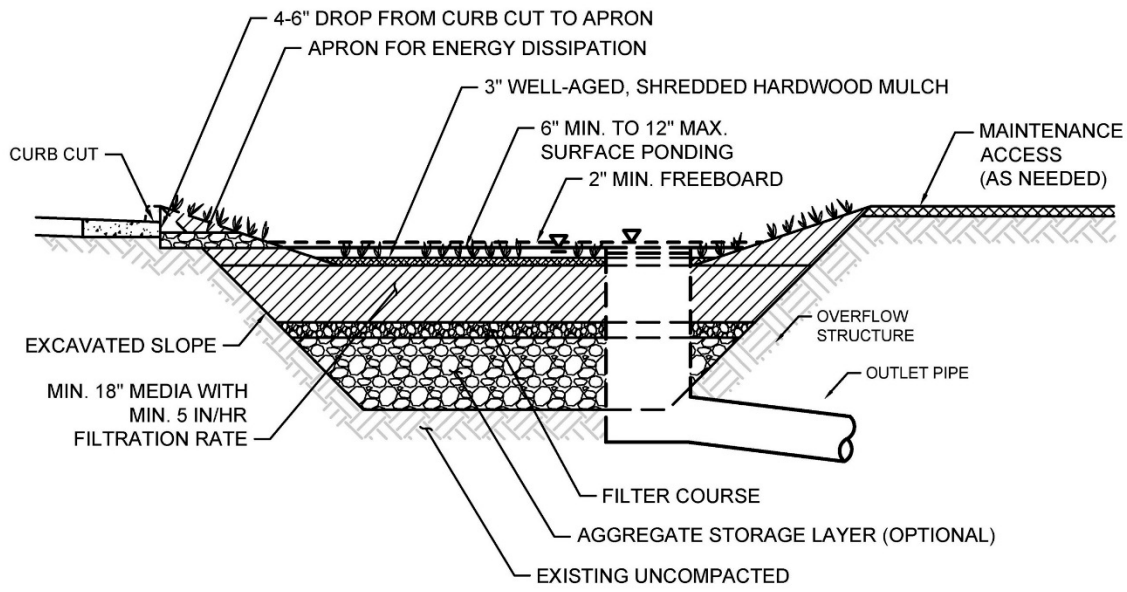

**SECTION A-A'**  
NOT TO SCALE

Typical plan and section view of a Bioretention BMP

**Design Adaptations for Project Goals**

**Full infiltration BMP for storm water pollutant control.** Bioretention can be used as a pollutant control BMP designed to infiltrate runoff from direct rainfall as well as runoff from adjacent tributary areas. Bioretention facilities must be designed with an infiltration storage volume (a function of the ponding, media and aggregate storage volumes) equal to the full DCV and able to meet drawdown time limitations.

**Integrated storm water flow control and pollutant control configuration.** Bioretention facilities can be designed to provide flow rate and duration control. This may be accomplished by providing greater infiltration storage with increased surface ponding and/or aggregate storage volume for storm water flow control.

**Recommended Siting Criteria**

<i>Siting Criteria</i>	<i>Intent/Rationale</i>
<input type="checkbox"/> Placement observes geotechnical recommendations regarding potential hazards (e.g., slope stability, landslides, liquefaction zones) and setbacks (e.g., slopes, foundations, utilities).	Must not negatively impact existing site geotechnical concerns.
<input type="checkbox"/> Selection and design of BMP is based on infiltration feasibility criteria and appropriate design infiltration rate presented in Appendix C and D.	Must operate as a full infiltration design and must be supported by drainage area and in-situ infiltration rate feasibility findings.
<input type="checkbox"/> Contributing tributary area is $\leq 5$ acres ( $\leq 1$ acre preferred).	Bigger BMPs require additional design features for proper performance.  Contributing tributary area greater than 5 acres may be allowed at the discretion of the City Engineer if the following conditions are met: 1) incorporate design features (e.g. flow spreaders) to minimizing short circuiting of flows in the BMP and 2) incorporate additional design features requested by the City Engineer for proper performance of the regional BMP.

<i>Siting Criteria</i>	<i>Intent/Rationale</i>
<input type="checkbox"/> Finish grade of the facility is $\leq 2\%$ . In long bioretention facilities where the potential for internal erosion and channelization exists, the use of check dams is required.	Flatter surfaces reduce erosion and channelization within the facility. Internal check dams reduce velocity and dissipate energy.

#### **Recommended BMP Component Dimensions**

<i>BMP Component</i>	<i>Dimension</i>	<i>Intent/Rationale</i>
Freeboard	$\geq 12$ inches	Freeboard provides room for head over overflow structures and minimizes risk of uncontrolled surface discharge.
Surface Ponding	$\geq 6$ and $\leq 12$ inches	<p>Surface ponding capacity lowers subsurface storage requirements. Deep surface ponding raises safety concerns.</p> <p>Surface ponding depth greater than 12 inches (for additional pollutant control or surface outlet structures or flow-control orifices) may be allowed at the discretion of the City Engineer if the following conditions are met: 1) surface ponding depth drawdown time is less than 24 hours; and 2) safety issues and fencing requirements are considered (typically ponding greater than 18" will require a fence and/or flatter side slopes) and 3) potential for elevated clogging risk is considered.</p>
Ponding Area Side Slopes	$\geq 3H:1V$	Gentler side slopes are safer, less prone to erosion, able to establish vegetation more quickly and easier to maintain.
Mulch	$\geq 3$ inches	Mulch will suppress weeds and maintain moisture for plant growth. Aging mulch kills pathogens and



<i>BMP Component</i>	<i>Dimension</i>	<i>Intent/Rationale</i>
		weed seeds and allows beneficial microbes to multiply.
Media Layer	≥ 18 inches	A deep media layer provides additional filtration and supports plants with deeper roots. Standard specifications shall be followed.

**Design Criteria and Considerations**

Bioretention must meet the following design criteria. Deviations from the below criteria may be approved at the discretion of the City Engineer if it is determined to be appropriate:

<i>Design Criteria</i>	<i>Intent/Rationale</i>
<b>Surface Ponding</b>	
<input type="checkbox"/> Surface ponding is limited to a 24-hour drawdown time.	<p>24-hour drawdown time is recommended for plant health.</p> <p>Surface ponding drawdown time greater than 24-hours but less than 96 hours may be allowed at the discretion of the City Engineer if certified by a landscape architect or agronomist.</p>
<b>Vegetation</b>	
<input type="checkbox"/> Plantings are suitable for the climate and expected ponding depth. A plant list to aid in selection can be found in Appendix E.26.	Plants suited to the climate and ponding depth are more likely to survive.
<input type="checkbox"/> An irrigation system with a connection to water supply is provided as needed.	Seasonal irrigation might be needed to keep plants healthy.
<b>Mulch (Optional)</b>	
<input type="checkbox"/> A minimum of 3 inches of well-aged, shredded hardwood mulch that has been stockpiled or stored for at least 12 months is provided. Mulch must be non-floating to avoid clogging of overflow structure.	Mulch will suppress weeds and maintain moisture for plant growth. Aging mulch kills pathogens and weed seeds and allows beneficial microbes to multiply.

<i>Design Criteria</i>	<i>Intent/Rationale</i>
<b>Media Layer</b>	
<input type="checkbox"/> Media maintains a minimum filtration rate of 5 in/hr over lifetime of facility. A minimum initial filtration rate of 10 in/hr is recommended.	<p>A high filtration rate through the soil mix minimizes clogging potential and allows flows to quickly enter the aggregate storage layer, thereby minimizing bypass.</p>
<input type="checkbox"/> Media is a minimum 18 inches deep, meeting either of these two media specifications: Section F.3 Bioretention Soil Media (BSM) or specific jurisdictional guidance.	<p>A deep media layer provides additional filtration and supports plants with deeper roots.</p> <p>Standard specifications shall be followed.</p>
<input type="checkbox"/> Alternatively, for proprietary designs and custom media mixes not meeting the media specifications, the media meets the pollutant treatment performance criteria in Section F.1.	<p>For non-standard or proprietary designs, compliance with F.1 ensures that adequate treatment performance will be provided.</p>
<input type="checkbox"/> Media surface area is 3% of contributing area times adjusted runoff factor or greater. Unless demonstrated that the BMP surface area can be smaller than 3%	<p>Greater surface area to tributary area ratios decrease loading rates per square foot and therefore increase longevity.</p> <p>Adjusted runoff factor is to account for site design BMPs implemented upstream of the BMP (such as rain barrels, impervious area dispersion, etc.). Refer to Appendix B.2 guidance.</p>
<b>Filter Course Layer (Optional)</b>	
<input type="checkbox"/> A filter course is used to prevent migration of fines through layers of the facility. Filter fabric is not used.	<p>Migration of media can cause clogging of the aggregate storage layer void spaces or subgrade. Filter fabric is more likely to clog.</p>
<input type="checkbox"/> Filter course is washed and free of fines.	<p>Washing aggregate will help eliminate fines that could clog the facility and impede infiltration.</p>
<input type="checkbox"/> Filter course calculations assessing suitability for particle migration prevention have been completed.	<p>Gradation relationship between layers can evaluate factors (e.g., bridging, permeability, and uniformity) to</p>

<i>Design Criteria</i>	<i>Intent/Rationale</i>
<b><i>Aggregate Storage Layer (Optional)</i></b>	determine if particle sizing is appropriate or if an intermediate layer is needed.
<input type="checkbox"/> Class 2 Permeable per Caltrans specification 68-1.025 is recommended for the storage layer. Washed, open-graded crushed rock may be used, however a 4-6 inch washed pea gravel filter course layer at the top of the crushed rock is required.	Washing aggregate will help eliminate fines that could clog the aggregate storage layer void spaces or subgrade.
<input type="checkbox"/> Maximum aggregate storage layer depth is determined based on the infiltration storage volume that will infiltrate within a 36-hour drawdown time.	A maximum drawdown time to facilitate provision of adequate storm water storage for the next storm event.
<b><i>Inflow and Overflow Structures</i></b>	
<input type="checkbox"/> Inflow and overflow structures are accessible for inspection and maintenance. Overflow structures must be connected to downstream storm drain system or appropriate discharge point.	Maintenance will prevent clogging and ensure proper operation of the flow control structures.
<input type="checkbox"/> Inflow velocities are limited to 3 ft/s or less or use energy dissipation methods (e.g., riprap, level spreader) for concentrated inflows.	High inflow velocities can cause erosion, scour and/or channeling.
<input type="checkbox"/> Curb cut inlets are at least 12 inches wide, have a 4-6 inch reveal (drop) and an apron and energy dissipation as needed.	Inlets must not restrict flow and apron prevents blockage from vegetation as it grows in. Energy dissipation prevents erosion.
<input type="checkbox"/> Overflow is safely conveyed to a downstream storm drain system or discharge point. Size overflow structure to pass 100-year peak flow for on-line basins and water quality peak flow for off-line basins.	Planning for overflow lessens the risk of property damage due to flooding.

**Conceptual Design and Sizing Approach for Storm Water Pollutant Control Only**

To design bioretention for storm water pollutant control only (no flow control required), the following steps should be taken:

1. Verify that siting and design criteria have been met, including placement and basin area requirements, maximum side and finish grade slope, and the recommended media surface area tributary ratio.
2. Calculate the DCV per Appendix B based on expected site design runoff for tributary areas.
3. Use the sizing worksheet to determine if full infiltration of the DCV is achievable based on the available infiltration storage volume calculated from the bioretention without underdrain footprint area, effective depths for surface ponding, media and aggregate storage layers, and in-situ soil design infiltration rate for a maximum 36-hour drawdown time for the aggregate storage layer, with surface ponding no greater than a maximum 24-hour drawdown. The drawdown time can be estimated by dividing the average depth of the basin by the design infiltration rate of the underlying soil. Appendix D provides guidance on evaluating a site's infiltration rate. A generic sizing worksheet is provided in Appendix B.4.
4. Where the DCV cannot be fully infiltrated based on the site or bioretention constraints, an underdrain can be added to the design (use biofiltration with partial retention factsheet).

### **Conceptual Design and Sizing Approach when Storm Water Flow Control is Applicable**

Control of flow rates and/or durations will typically require significant surface ponding and/or aggregate storage volumes, and therefore the following steps should be taken prior to determination of storm water pollutant control design. Pre-development and allowable post-project flow rates and durations shall be determined as discussed in Chapter 6 of the manual.

1. Verify that siting and design criteria have been met, including placement requirements, maximum side and finish grade slopes, and the recommended media surface area tributary area ratio. Design for flow control can be achieved using various design configurations.
2. Iteratively determine the facility footprint area, surface ponding and/or aggregate storage layer depth required to provide infiltration storage to reduce flow rates and durations to allowable limits while adhering to the maximum drawdown times for surface ponding and aggregate storage. Flow rates and durations can be controlled using flow splitters that route the appropriate inflow amounts to the bioretention facility and bypass excess flows to the downstream storm drain system or discharge point.
3. If bioretention without underdrain facility cannot fully provide the flow rate and duration control required by the MS4 permit, an upstream or downstream structure with appropriate storage volume such as an underground vault can be used to provide additional control.
4. After bioretention without underdrain BMPs have been designed to meet flow control requirements, calculations must be completed to verify if storm water pollutant control requirements to treat the DCV have been met.

### **Maintenance Overview**

**Normal Expected Maintenance.** Bioretention requires routine maintenance to: remove

accumulated materials such as sediment, trash or debris; maintain vegetation health; maintain infiltration capacity of the media layer; replenish mulch; and maintain integrity of side slopes, inlets, energy dissipators, and outlets. A summary table of standard inspection and maintenance indicators is provided within this Fact Sheet.

**Non-Standard Maintenance or BMP Failure.** If any of the following scenarios are observed, the BMP is not performing as intended to protect downstream waterways from pollution and/or erosion. Corrective maintenance, increased inspection and maintenance, BMP replacement, or a different BMP type will be required.

- The BMP is not drained between storm events. Surface ponding longer than approximately 24 hours following a storm event may be detrimental to vegetation health, and surface ponding longer than approximately 96 hours following a storm event poses a risk of vector (mosquito) breeding. Poor drainage can result from clogging of the media layer, filter course, aggregate storage layer, underlying native soils, or outlet structure. The specific cause of the drainage issue must be determined and corrected. If it is determined that the underlying native soils have been compacted or do not have the infiltration capacity expected, the City Engineer shall be contacted prior to any additional repairs or reconstruction.
- Sediment, trash, or debris accumulation greater than 25% of the surface ponding volume within one month. This means the load from the tributary drainage area is too high, reducing BMP function or clogging the BMP. This would require pretreatment measures within the tributary area draining to the BMP to intercept the materials. Pretreatment components, especially for sediment, will extend the life of components that are more expensive to replace such as media, filter course, and aggregate layers.
- Erosion due to concentrated storm water runoff flow that is not readily corrected by adding erosion control blankets, adding stone at flow entry points, or minor re-grading to restore proper drainage according to the original plan. If the issue is not corrected by restoring the BMP to the original plan and grade, the City Engineer shall be contacted prior to any additional repairs or reconstruction.

**Other Special Considerations.** Bioretention is a vegetated structural BMP. Vegetated structural BMPs that are constructed in the vicinity of, or connected to, an existing jurisdictional water or wetland could inadvertently result in creation of expanded waters or wetlands. As such, vegetated structural BMPs have the potential to come under the jurisdiction of the United States Army Corps of Engineers, SDRWQCB, California Department of Fish and Wildlife, or the United States Fish and Wildlife Service. This could result in the need for specific resource agency permits and costly mitigation to perform maintenance of the structural BMP. Along with proper placement of a structural BMP, routine maintenance is key to preventing this scenario.

**Sediment Loading:** Consider the effects of BMP design and tributary area land uses on the clogging potential of the BMP. Complete the sediment loading analysis included in Appendix E.27.

**Summary of Standard Inspection and Maintenance**

The property owner is responsible to ensure inspection, operation and maintenance of permanent BMPs on their property unless responsibility has been formally transferred to an agency, community facilities district, homeowners association, property owners association, or other special district.

Maintenance frequencies listed in this table are average/typical frequencies. Actual maintenance needs are site-specific, and maintenance may be required more frequently. Maintenance must be performed whenever needed, based on maintenance indicators presented in this table. The BMP owner is responsible for conducting regular inspections to see when maintenance is needed based on the maintenance indicators. During the first year of operation of a structural BMP, inspection is recommended at least once prior to August 31 and then monthly from September through May. Inspection during a storm event is also recommended. After the initial period of frequent inspections, the minimum inspection and maintenance frequency can be determined based on the results of the first year inspections.

Threshold/Indicator	Maintenance Action	Typical Maintenance Frequency
Accumulation of sediment, litter, or debris	Remove and properly dispose of accumulated materials, without damage to the vegetation or compaction of the media layer.	<ul style="list-style-type: none"> <li>• Inspect monthly. If the BMP is 25% full* or more in one month, increase inspection frequency to monthly plus after every 0.1-inch or larger storm event.</li> <li>• Remove any accumulated materials found at each inspection.</li> </ul>
Obstructed inlet or outlet structure	Clear blockage.	<ul style="list-style-type: none"> <li>• Inspect monthly and after every 0.5-inch or larger storm event.</li> <li>• Remove any accumulated materials found at each inspection.</li> </ul>
Damage to structural components such as weirs, inlet or outlet structures	Repair or replace as applicable.	<ul style="list-style-type: none"> <li>• Inspect annually.</li> <li>• Maintain when needed.</li> </ul>

Threshold/Indicator	Maintenance Action	Typical Maintenance Frequency
Poor vegetation establishment	Re-seed, re-plant, or re-establish vegetation per original plans.	<ul style="list-style-type: none"> <li>• Inspect monthly.</li> <li>• Maintain when needed.</li> </ul>
Dead or diseased vegetation	Remove dead or diseased vegetation, re-seed, re-plant, or re-establish vegetation per original plans.	<ul style="list-style-type: none"> <li>• Inspect monthly.</li> <li>• Maintain when needed.</li> </ul>
Overgrown vegetation	Mow or trim as appropriate.	<ul style="list-style-type: none"> <li>• Inspect monthly.</li> <li>• Maintain when needed.</li> </ul>
2/3 of mulch has decomposed, or mulch has been removed	Remove decomposed fraction and top off with fresh mulch to a total depth of 3 inches.	<ul style="list-style-type: none"> <li>• Inspect monthly.</li> <li>• Replenish mulch annually, or more frequently when needed based on inspection.</li> </ul>
Erosion due to concentrated irrigation flow	Repair/re-seed/re-plant eroded areas and adjust the irrigation system.	<ul style="list-style-type: none"> <li>• Inspect monthly.</li> <li>• Maintain when needed.</li> </ul>
Erosion due to concentrated storm water runoff flow	Repair/re-seed/re-plant eroded areas, and make appropriate corrective measures such as adding erosion control blankets, adding stone at flow entry points, or minor re-grading to restore proper drainage according to the original plan. If the issue is not corrected by restoring the BMP to the original plan and grade, the City Engineer shall be contacted prior to any additional repairs or reconstruction.	<ul style="list-style-type: none"> <li>• Inspect after every 0.5-inch or larger storm event. If erosion due to storm water flow has been observed, increase inspection frequency to after every 0.1-inch or larger storm event.</li> <li>• Maintain when needed. If the issue is not corrected by restoring the BMP to the original plan and grade, the City Engineer shall be contacted prior to any additional repairs or reconstruction.</li> </ul>

Threshold/Indicator	Maintenance Action	Typical Maintenance Frequency
<p>Standing water in BMP for longer than 24 hours following a storm event</p> <p>Surface ponding longer than approximately 24 hours following a storm event may be detrimental to vegetation health</p>	<p>Make appropriate corrective measures such as adjusting irrigation system, removing obstructions of debris or invasive vegetation, or repairing/replacing clogged or compacted soils. If it is determined that the underlying native soils have been compacted or do not have the infiltration capacity expected, the City Engineer shall be contacted prior to any additional repairs or reconstruction.</p>	<ul style="list-style-type: none"> <li>● Inspect monthly and after every 0.5-inch or larger storm event. If standing water is observed, increase inspection frequency to after every 0.1-inch or larger storm event.</li> <li>● Maintain when needed.</li> </ul>
<p>Presence of mosquitos/larvae</p> <p>For images of egg rafts, larva, pupa, and adult mosquitos, see <a href="http://www.mosquito.org/biology">http://www.mosquito.org/biology</a></p>	<p>If mosquitos/larvae are observed: first, immediately remove any standing water by dispersing to nearby landscaping; second, make corrective measures as applicable to restore BMP drainage to prevent standing water.</p> <p>If mosquitos persist following corrective measures to remove standing water, or if the BMP design does not meet the 96-hour drawdown criteria because the underlying native soils have been compacted or do not have the infiltration capacity expected, the City Engineer shall be contacted to determine a solution. A different BMP type, or a Vector Management Plan prepared with concurrence from the County of San Diego Department of Environmental Health, may be required.</p>	<ul style="list-style-type: none"> <li>● Inspect monthly and after every 0.5-inch or larger storm event. If mosquitos are observed, increase inspection frequency to after every 0.1-inch or larger storm event.</li> <li>● Maintain when needed.</li> </ul>

“25% full” is defined as ¼ of the depth from the design bottom elevation to the crest of the outflow structure (e.g., if the height to the outflow opening is 12 inches from the bottom elevation, then the materials must be removed when there is 3 inches of accumulation – this should be marked on the outflow structure).



## E.15 INF-3 Permeable Pavement (Pollutant Control)



Location: Kellogg Park, San Diego, California

---

**MS4 Permit Category**

---

Retention  
Flow-thru Treatment  
Control

---

**Manual Category**

---

Infiltration  
Flow-thru Treatment  
Control

---

**Applicable Performance Standard**

---

Pollutant Control  
Flow Control

---

**Primary Benefits**

---

Volume Reduction  
Peak Flow Attenuation

---

**Description**

---

Permeable pavement is pavement that allows for percolation through void spaces in the pavement surface into subsurface layers. The subsurface layers are designed to provide storage of storm water runoff so that outflows, primarily via infiltration into subgrade soils or release to the downstream conveyance system, can be at controlled rates. Varying levels of storm water treatment and flow control can be provided depending on the size of the permeable pavement system relative to its drainage area, the underlying infiltration rates, and the configuration of outflow controls. Pollutant control permeable pavement is designed to receive runoff from a larger tributary area than site design permeable pavement (see SD-6B). Pollutant control is provided via infiltration, filtration, sorption, sedimentation, and biodegradation processes.

Typical permeable pavement components include, from top to bottom:

- Permeable surface layer
- Bedding layer for permeable surface
- Aggregate storage layer with optional underdrain(s)
- Optional final filter course layer over uncompacted existing subgrade

E.15: INF-3 Permeable Pavement (Pollutant Control)

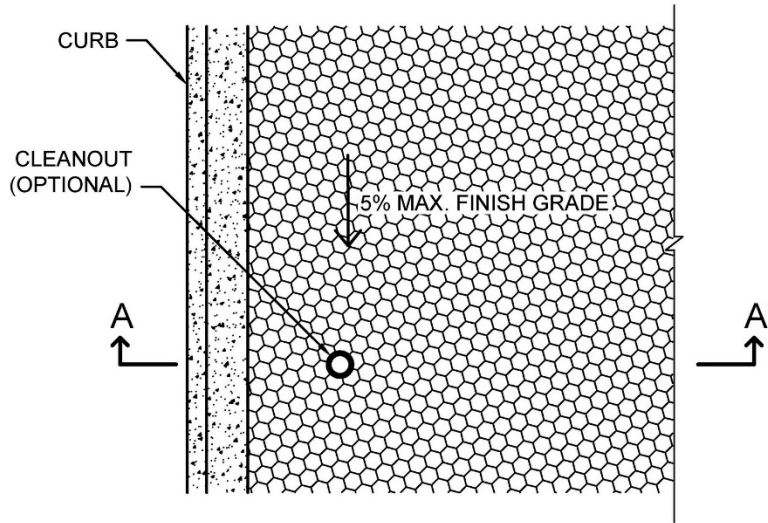

PLAN  
NOT TO SCALE

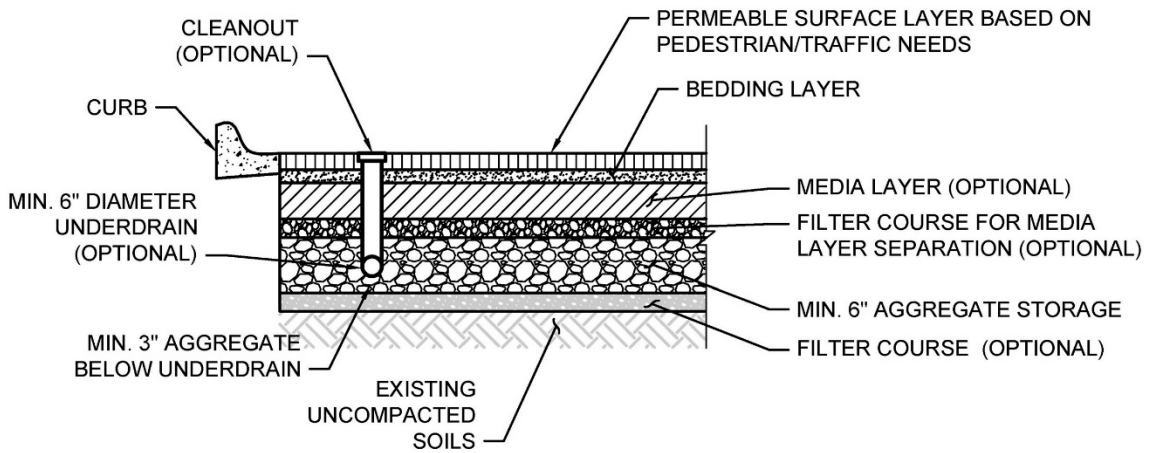

SECTION A-A'  
NOT TO SCALE

Typical plan and Section view of a Permeable Pavement BMP

## E.15: INF-3 Permeable Pavement (Pollutant Control)

Subcategories of permeable pavement include modular paver units or paver blocks, pervious concrete, porous asphalt, and turf pavers. These subcategory variations differ in the material used for the permeable surface layer but have similar functions and characteristics below this layer.

### ***Design Adaptations for Project Goals***

**Site design BMP to reduce impervious area and DCV.** See site design option SD-6B.

**Full infiltration BMP for storm water pollutant control.** Permeable pavement without an underdrain and without impermeable liners can be used as a pollutant control BMP, designed to infiltrate runoff from direct rainfall as well as runoff from adjacent areas that are tributary to the pavement. The system must be designed with an infiltration storage volume (a function of the aggregate storage volume) equal to the full DCV and able to meet drawdown time limitations.

**Partial infiltration BMP with flow-thru treatment for storm water pollutant control.** Permeable pavement can be designed so that a portion of the DCV is infiltrated by providing an underdrain with infiltration storage below the underdrain invert. The infiltration storage depth should be determined by the volume that can be reliably infiltrated within drawdown time limitations. Water discharged through the underdrain is considered flow-thru treatment and is not considered biofiltration treatment. Storage provided above the underdrain invert is included in the flow-thru treatment volume.

**Flow-thru treatment BMP for storm water pollutant control.** The system may be lined and/or installed over impermeable native soils with an underdrain provided at the bottom to carry away filtered runoff. Water quality treatment is provided via unit treatment processes other than infiltration. This configuration is considered to provide flow-thru treatment, not biofiltration treatment. Significant aggregate storage provided above the underdrain invert can provide detention storage, which can be controlled via inclusion of an orifice in an outlet structure at the downstream end of the underdrain. **PDPs have the option to add saturated storage to the flow-thru configuration in order to reduce the DCV that the BMP is required to treat.** Saturated storage can be added to this design by including an upturned elbow installed at the downstream end of the underdrain or via an internal weir structure designed to maintain a specific water level elevation. The DCV can be reduced by the amount of saturated storage provided.

**Integrated storm water flow control and pollutant control configuration.** With any of the above configurations, the system can be designed to provide flow rate and duration control. This may include having a deeper aggregate storage layer that allows for significant detention storage above the underdrain, which can be further controlled via inclusion of an outlet structure at the downstream end of the underdrain.

E.15: INF-3 Permeable Pavement (Pollutant Control)

**Recommended Siting Criteria**

<i>Siting Criteria</i>	<i>Intent/Rationale</i>
<input type="checkbox"/> Placement observes geotechnical recommendations regarding potential hazards (e.g., slope stability, landslides, liquefaction zones) and setbacks (e.g., slopes, foundations, utilities).	Must not negatively impact existing site geotechnical concerns.
<input type="checkbox"/> Selection must be based on infiltration feasibility criteria.	Full or partial infiltration designs must be supported by drainage area feasibility findings.
<input type="checkbox"/> Permeable pavement is not placed in an area with significant overhanging trees or other vegetation.	Leaves and organic debris can clog the pavement surface.
<input type="checkbox"/> Minimum depth to groundwater and bedrock $\geq 10$ ft.	A minimum separation facilitates infiltration and lessens the risk of negative groundwater impacts.
<input type="checkbox"/> Contributing tributary area includes effective sediment source control and/or pretreatment measures such as raised curbed or grass filter strips.	Sediment can clog the pavement surface.
<input type="checkbox"/> Direct discharges to permeable pavement are only from downspouts carrying “clean” roof runoff that are equipped with filters to remove gross solids.	Roof runoff typically carries less sediment than runoff from other impervious surfaces and is less likely to clog the pavement surface.

**Recommended BMP Component Dimensions**

<i>BMP Component</i>	<i>Dimension</i>	<i>Intent/Rationale</i>
Bedding Layer	1-2 inches (typical)	Bedding (e.g., sand, aggregate) provided to stabilize and level the surface.
Aggregate Storage	$\geq 6$ inches	A minimum depth of aggregate provides structural stability for expected pavement loads.
Underdrain Diameter	$\geq 6$ inches	Smaller diameter underdrains are prone to clogging.

E.15: INF-3 Permeable Pavement (Pollutant Control)

**Design Criteria and Considerations**

Permeable pavements must meet the following design criteria. Deviations from the below criteria may be approved at the discretion of the City Engineer if it is determined to be appropriate:

<i>Design Criteria</i>	<i>Intent/Rationale</i>
<input type="checkbox"/> An impermeable liner or other hydraulic restriction layer is included if site constraints indicate that infiltration should not be allowed.	Lining prevents storm water from impacting groundwater and/or sensitive environmental or geotechnical features. Incidental infiltration, when allowable, can aid in pollutant removal and groundwater recharge.
<input type="checkbox"/> For pollutant control permeable pavement, the ratio of the total drainage area (including the permeable pavement) to the permeable pavement should not exceed 4:1.	Higher ratios increase the potential for clogging but may be acceptable for relatively clean tributary areas.
<input type="checkbox"/> Finish grade of the permeable pavement has a slope $\leq 5\%$ .	Flatter surfaces facilitate increased runoff capture.
<b>Permeable Surface Layer</b>	
<input type="checkbox"/> Permeable surface layer type is appropriately chosen based on pavement use and expected vehicular loading.	Pavement may wear more quickly if not durable for expected loads or frequencies.
<input type="checkbox"/> Permeable surface layer type is appropriate for expected pedestrian traffic.	Expected demographic and accessibility needs (e.g., adults, children, seniors, runners, high-heeled shoes, wheelchairs, strollers, bikes) requires selection of appropriate surface layer type that will not impede pedestrian needs.
<b>Bedding Layer for Permeable Surface</b>	
<input type="checkbox"/> Bedding thickness and material is appropriate for the chosen permeable surface layer type.	<p>Porous asphalt requires a 2- to 4-inch layer of asphalt and a 1- to 2-inch layer of choker course (single-sized crushed aggregate, one-half inch) to stabilize the surface.</p> <p>Pervious concrete also requires an aggregate course of clean gravel or</p>

**E.15: INF-3 Permeable Pavement (Pollutant Control)**

<i>Design Criteria</i>	<i>Intent/Rationale</i>
	<p>crushed stone with a minimum amount of fines.</p> <p>Permeable Interlocking Concrete Paver requires 1 or 2 inches of sand or No. 8 aggregate to allow for leveling of the paver blocks.</p> <p>Similar to Permeable Interlocking Concrete Paver, plastic grid systems also require a 1- to 2-inch bedding course of either gravel or sand.</p> <p>For Permeable Interlocking Concrete Paver and plastic grid systems, if sand is used, a geotextile should be used between the sand course and the reservoir media to prevent the sand from migrating into the stone media.</p>
<p><input type="checkbox"/> Aggregate used for bedding layer is washed prior to placement.</p>	<p>Washing aggregate will help eliminate fines that could clog the permeable pavement system aggregate storage layer void spaces or underdrain.</p>
<p><b><i>Media Layer (Optional) –used between bedding layer and aggregate storage layer to provide pollutant treatment control</i></b></p>	
<p><input type="checkbox"/> The pollutant removal performance of the media layer is documented by the applicant.</p>	<p>Media used for BMP design should be shown via research or testing to be appropriate for expected pollutants of concern and flow rates.</p>
<p><input type="checkbox"/> A filter course is provided to separate the media layer from the aggregate storage layer.</p>	<p>Migration of media can cause clogging of the aggregate storage layer void spaces or underdrain.</p>
<p><input type="checkbox"/> If a filter course is used, calculations assessing suitability for particle migration prevention have been completed.</p>	<p>Gradation relationship between layers can evaluate factors (e.g., bridging, permeability, and uniformity) to determine if particle sizing is appropriate or if an intermediate layer is needed.</p>

**E.15: INF-3 Permeable Pavement (Pollutant Control)**

<i>Design Criteria</i>	<i>Intent/Rationale</i>
<input type="checkbox"/> Consult permeable pavement manufacturer to verify that media layer provides required structural support.	Media must not compromise the structural integrity or intended uses of the permeable pavement surface.
<b><i>Aggregate Storage Layer</i></b>	
<input type="checkbox"/> Aggregate used for the aggregate storage layer is washed and free of fines.	Washing aggregate will help eliminate fines that could clog aggregate storage layer void spaces or underdrain.
<input type="checkbox"/> Minimum layer depth is 6 inches and for infiltration designs, the maximum depth is determined based on the infiltration storage volume that will infiltrate within a 36-hour drawdown time.	A minimum depth of aggregate provides structural stability for expected pavement loads.
<b><i>Underdrain and Outflow Structures</i></b>	
<input type="checkbox"/> Underdrains and outflow structures, if used, are accessible for inspection and maintenance.	Maintenance will improve the performance and extend the life of the permeable pavement system.
<input type="checkbox"/> Underdrain outlet elevation should be a minimum of 3 inches above the bottom elevation of the aggregate storage layer.	A minimal separation from subgrade or the liner lessens the risk of fines entering the underdrain and can improve hydraulic performance by allowing perforations to remain unblocked.
<input type="checkbox"/> Minimum underdrain diameter is 6 inches.	Smaller diameter underdrains are prone to clogging.
<input type="checkbox"/> Underdrains are made of slotted, PVC pipe conforming to ASTM D 3034 or equivalent or corrugated, HDPE pipe conforming to AASHTO 252M or equivalent.	Slotted underdrains provide greater intake capacity, clog resistant drainage, and reduced entrance velocity into the pipe, thereby reducing the chances of solids migration.
<b><i>Filter Course (Optional)</i></b>	
<input type="checkbox"/> Filter course is washed and free of fines.	Washing aggregate will help eliminate fines that could clog subgrade and impede infiltration.

**Conceptual Design and Sizing Approach for Site Design**

1. Determine the areas where permeable pavement can be used in the site design to replace traditional pavement to reduce the impervious area and DCV. These permeable pavement

## E.15: INF-3 Permeable Pavement (Pollutant Control)

areas can be credited toward reducing runoff generated through representation in storm water calculations as pervious, not impervious, areas but are not credited for storm water pollutant control. These permeable pavement areas should be designed as self-retaining with the appropriate tributary area ratio identified in the design criteria.

2. Calculate the DCV per Appendix B, taking into account reduced runoff from self-retaining permeable pavement areas.

### ***Conceptual Design and Sizing Approach for Storm Water Pollutant Control Only***

To design permeable pavement for storm water pollutant control only (no flow control required), the following steps should be taken:

1. Verify that siting and design criteria have been met, including placement requirements, maximum finish grade slope, and the recommended tributary area ratio for non-self-retaining permeable pavement. If infiltration is infeasible, the permeable pavement can be designed as flow-thru treatment per the sizing worksheet. If infiltration is feasible, calculations should follow the remaining design steps.
2. Calculate the DCV per Appendix B based on expected site design runoff for tributary areas.
3. Use the sizing worksheet to determine if full or partial infiltration of the DCV is achievable based on the available infiltration storage volume calculated from the permeable pavement footprint, aggregate storage layer depth, and in-situ soil design infiltration rate for a maximum 36-hour drawdown time. The applicant has an option to use a different drawdown time up to 96 hours if the volume of the facility is adjusted using the percent capture method in Appendix B.4.2.
4. Where the DCV cannot be fully infiltrated based on the site or permeable pavement constraints, an underdrain must be incorporated above the infiltration storage to carry away runoff that exceeds the infiltration storage capacity.
5. The remaining DCV to be treated should be calculated for use in sizing downstream BMP(s).

### ***Conceptual Design and Sizing Approach when Storm Water Flow Control is Applicable***

Control of flow rates and/or durations will typically require significant aggregate storage volumes, and therefore the following steps should be taken prior to determination of storm water pollutant control design. Pre-development and allowable post-project flow rates and durations should be determined as discussed in Chapter 6 of the manual.

1. Verify that siting and design criteria have been met, including placement requirements, maximum finish grade slope, and the recommended tributary area ratio for non-self-retaining permeable pavement. Design for flow control can be achieved using various design



## E.15: INF-3 Permeable Pavement (Pollutant Control)

configurations, but a flow-thru treatment design will typically require a greater aggregate storage layer volume than designs which allow for full or partial infiltration of the DCV.

2. Iteratively determine the area and aggregate storage layer depth required to provide infiltration and/or detention storage to reduce flow rates and durations to allowable limits. Flow rates and durations can be controlled from detention storage by altering outlet structure orifice size(s) and/or water control levels. Multi-level orifices can be used within an outlet structure to control the full range of flows.
3. If the permeable pavement system cannot fully provide the flow rate and duration control required by this manual, a downstream structure with sufficient storage volume such as an underground vault can be used to provide remaining controls.
4. After permeable pavement has been designed to meet flow control requirements, calculations must be completed to verify if storm water pollutant control requirements to treat the DCV have been met.

### **Maintenance Overview**

**Normal Expected Maintenance.** Routine maintenance of permeable pavement includes: removal of materials such as trash and debris accumulated on the paving surface; vacuuming of the paving surface to prevent clogging; and flushing paving and subsurface gravel to remove fine sediment. If the BMP includes underdrains and/or an outflow control structure, check and clear these features.

**Non-Standard Maintenance or BMP Failure.** If the permeable pavement area is not drained between storm events, or if runoff sheet flows across the permeable pavement area and flows off the permeable pavement area during storm events, the BMP is not performing as intended to protect downstream waterways from pollution and/or erosion. During storm events up to the 85th percentile storm event (approximately 0.5 to 1 inch of rainfall in San Diego County), runoff should not flow off the permeable pavement area. The permeable pavement area is expected to have adequate hydraulic conductivity and storage such that rainfall landing on the permeable pavement and runoff from the surrounding drainage area will go directly into the pavement without ponding or overflow (in properly designed systems, the surrounding drainage area is not more than half as large as the permeable pavement area). Following the storm event, there should be no standing water (puddles) on the permeable pavement area.

If storm water is flowing off the permeable pavement during a storm event, or if there is standing water on the permeable pavement surface following a storm event, this is an indicator of clogging somewhere within the system. Poor drainage can result from clogging of the permeable surface layer, any of the subsurface components, or the subgrade soils. The specific cause of the drainage issue must be determined and corrected. Surface or subsurface ponding longer than approximately 96 hours following a storm event poses a risk of vector (mosquito) breeding. Corrective maintenance, increased

### E.15: INF-3 Permeable Pavement (Pollutant Control)

inspection and maintenance, BMP replacement, or a different BMP type will be required. If poor drainage persists after flushing of the paving, subsurface gravel, and/or underdrain(s) when applicable, or if it is determined that the underlying soils do not have the infiltration capacity expected, the City Engineer shall be contacted prior to any additional repairs or reconstruction.

**Other Special Considerations.** The runoff storage and infiltration surface area in this BMP are not readily accessible because they are subsurface. This means that clogging and poor drainage are not easily corrected. If the tributary area draining to the BMP includes unpaved areas, the sediment load from the tributary drainage area can be too high, reducing BMP function or clogging the BMP. All unpaved areas within the tributary drainage area should be stabilized with vegetation. Other pretreatment components to prevent transport of sediment to the paving surface, such as grass buffer strips, will extend the life of the subsurface components and infiltration surface. Along with proper stabilization measures and pretreatment within the tributary area, routine maintenance, including preventive vacuum/regenerative air street sweeping, is key to preventing clogging.

City shall have the right to require qualified third-party testing at the property owner's expense when poor drainage condition is suspected. The project owner will be required to repair or reinstall any failing permeable surface to standards established in the approved grading permit.

**Summary of Standard Inspection and Maintenance**

The property owner is responsible to ensure inspection, operation and maintenance of permanent BMPs on their property unless responsibility has been formally transferred to an agency, community facilities district, homeowners association, property owners association, or other special district.

Maintenance frequencies listed in this table are average/typical frequencies. Actual maintenance needs are site-specific, and maintenance may be required more frequently. Maintenance must be performed whenever needed, based on maintenance indicators presented in this table. The BMP owner is responsible for conducting regular inspections to see when maintenance is needed based on the maintenance indicators. During the first year of operation of a structural BMP, inspection is recommended at least once prior to August 31 and then monthly from September through May. Inspection during a storm event is also recommended. After the initial period of frequent inspections, the minimum inspection and maintenance frequency can be determined based on the results of the first year inspections.

Threshold/Indicator	Maintenance Action	Typical Maintenance Frequency
Preventive vacuum/regenerative air street sweeping	Pavement should be swept with a vacuum power or regenerative air street sweeper to maintain infiltration through paving surface	<ul style="list-style-type: none"> <li>• Schedule/perform this preventive action at least twice per year.</li> </ul>
Accumulation of sediment, litter, or debris on permeable pavement surface	Remove and properly dispose of accumulated materials. Inspect tributary area for exposed soil or other sources of sediment and apply stabilization measures to sediment source areas. Apply source control measures as applicable to sources of litter or debris.	<ul style="list-style-type: none"> <li>• Inspect monthly and after every 0.5-inch or larger storm event.</li> <li>• Remove any accumulated materials found at each inspection.</li> </ul>

**E.15: INF-3 Permeable Pavement (Pollutant Control)**

Threshold/Indicator	Maintenance Action	Typical Maintenance Frequency
Weeds growing on/through the permeable pavement surface	Remove weeds and add features as necessary to prevent weed intrusion. Use non-chemical methods (e.g., instead of pesticides, control weeds using mechanical removal, physical barriers, and/or physical changes in the surrounding area adjacent to pavement that will preclude weed intrusion into the pavement).	<ul style="list-style-type: none"> <li>• Inspect monthly.</li> <li>• Remove any weeds found at each inspection.</li> </ul>
Standing water in permeable paving area or subsurface infiltration gallery for longer than 24-96 hours following a storm event	This condition requires investigation of why infiltration is not occurring. If feasible, corrective action shall be taken to restore infiltration (e.g., pavement should be swept with a vacuum power or regenerative air street sweeper to restore infiltration rates, clear underdrains if underdrains are present). BMP may require retrofit if infiltration cannot be restored. The City Engineer shall be contacted prior to any repairs or reconstruction.	<ul style="list-style-type: none"> <li>• Inspect monthly and after every 0.5-inch or larger storm event. If standing water is observed, increase inspection frequency to after every 0.1-inch or larger storm event.</li> <li>• Maintain when needed.</li> </ul>

**E.15: INF-3 Permeable Pavement (Pollutant Control)**

Threshold/Indicator	Maintenance Action	Typical Maintenance Frequency
<p>Presence of mosquitos/larvae</p> <p>For images of egg rafts, larva, pupa, and adult mosquitos, see <a href="http://www.mosquito.org/biology">http://www.mosquito.org/biology</a></p>	<p>If mosquitos/larvae are observed: first, immediately remove any standing water by dispersing to nearby landscaping; second, make corrective measures as applicable to restore BMP drainage to prevent standing water.</p> <p>If mosquitos persist following corrective measures to remove standing water, or if the BMP design does not meet the 96-hour drawdown criteria because the underlying native soils have been compacted or do not have the infiltration capacity expected, the City Engineer shall be contacted to determine a solution. A different BMP type, or a Vector Management Plan prepared with concurrence from the County of San Diego Department of Environmental Health, may be required.</p>	<ul style="list-style-type: none"> <li>• Inspect monthly and after every 0.5-inch or larger storm event. If mosquitos are observed, increase inspection frequency to after every 0.1-inch or larger storm event.</li> <li>• Maintain when needed.</li> </ul>
<p>Obstructed underdrain or outlet structure (when the BMP includes outflow control structure for runoff released from subsurface storage via underdrain(s))</p>	<p>Clear blockage.</p>	<ul style="list-style-type: none"> <li>• Inspect if standing water is observed for longer than 24-96 hours following a storm event.</li> <li>• Maintain when needed.</li> </ul>
<p>Damage to structural components of subsurface infiltration gallery such as weirs or outlet structures</p>	<p>Repair or replace as applicable.</p>	<ul style="list-style-type: none"> <li>• Inspect annually.</li> <li>• Maintain when needed.</li> </ul>

E.15: INF-3 Permeable Pavement (Pollutant Control)

Threshold/Indicator	Maintenance Action	Typical Maintenance Frequency
Damage to permeable paving surface (e.g., cracks, settlement, misaligned paver blocks, void spaces between paver blocks need fill materials replenished)	Repair or replace damaged surface as appropriate.	<ul style="list-style-type: none"><li>• Inspect annually.</li><li>• Maintain when needed.</li></ul>

## E.16 INF-4 Dry Wells

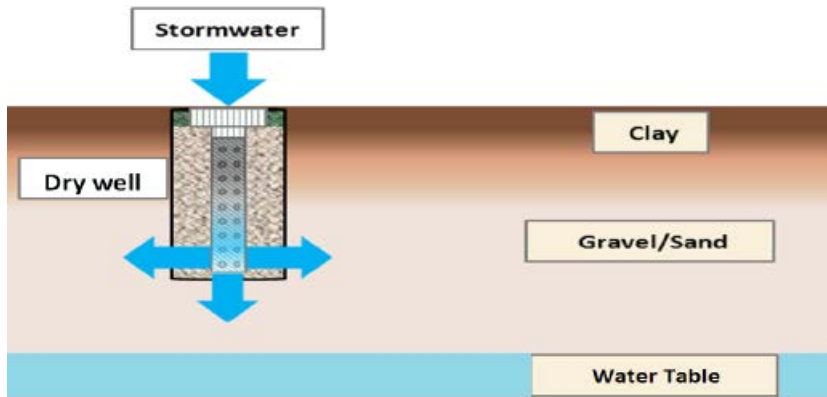
**MS4 Permit Category**

Retention

**BMP Manual Category**

Infiltration

**Applicable Performance Standard**

Pollutant Control

Flow Control

**Primary Benefits**

Volume Reduction

Source: Cal/EPA Fact Sheet on Dry Wells

**Description**

A dry well typically consists of a gravity-fed pit, deeper than it is long or wide, lined with perforated casing and often backfilled with gravel or stone. Dry wells penetrate layers of poorly infiltrating soils, such as clays, allowing infiltration into deeper permeable layers. Dry wells reduce storm water runoff while increasing groundwater recharge. Dry wells require pretreatment. Pretreatment effectiveness is contingent upon proper maintenance pretreatment devices.

**Criteria for Use of a Dry Well as an Infiltration BMP**

A dry well may be acceptable as an “infiltration BMP” if it meets **ALL** the following criteria:

- The BMP meets the minimum geotechnical and groundwater investigation requirements listed in **Appendix C**; and
- The BMP is evaluated by approved infiltration rate assessment methods presented in **Appendix D**; and
- Implements an appropriate pretreatment BMP (refer to **Appendix B.6.2** for selection); and
- Dry wells serving lots other than single-family homes are **registered with the US EPA** (additional information and registration forms can be found at: <https://www.epa.gov/uic>).

## E.17 PR-1 Biofiltration with Partial Retention



*Location: 805 and Bonita Road, Chula vista, CA.*

---

**MS4 Permit Category**

---

NA

---

**Manual Category**

---

Partial Retention

---

**Applicable Performance Standard**

---

Pollutant Control

Flow Control

---

**Primary Benefits**

---

Volume Reduction

Treatment

Peak Flow Attenuation

---

**Description**

---

Biofiltration with partial retention (partial infiltration and biofiltration) facilities are vegetated surface water systems that filter water through vegetation, and soil or engineered media prior to infiltrating into native soils, discharge via underdrain, or overflow to the downstream conveyance system. Where feasible, these BMPs have an elevated underdrain discharge point that creates storage capacity in the aggregate storage layer. Biofiltration with partial retention facilities are commonly incorporated into the site within parking lot landscaping, along roadsides, and in open spaces. They can be constructed in ground or partially aboveground, such as planter boxes with open bottoms to allow infiltration. Treatment is achieved through filtration, sedimentation, sorption, infiltration, biochemical processes and plant uptake.

Typical biofiltration with partial retention components include:

- Inflow distribution mechanisms (e.g, perimeter flow spreader or filter strips)
- Energy dissipation mechanism for concentrated inflows (e.g., splash blocks or riprap)
- Shallow surface ponding for captured flows
- Side Slope and basin bottom vegetation selected based on climate and ponding depth
- Non-floating mulch layer (Optional)
- Media layer (planting mix or engineered media) capable of supporting vegetation growth
- Filter course layer consisting of aggregate to prevent the migration of fines into uncompacted native soils or the optional aggregate storage layer
- Aggregate storage layer with underdrain(s)
- Uncompacted native soils at the bottom of the facility



E.17: PR-1 Biofiltration with Partial Retention

- Overflow structure

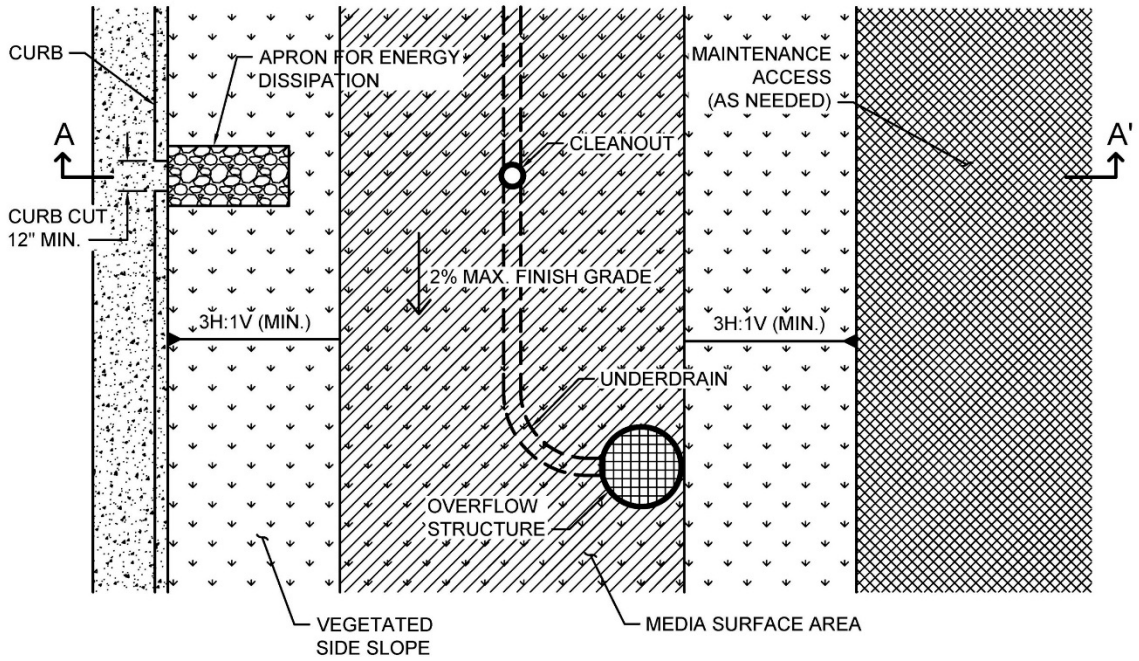

**PLAN**  
NOT TO SCALE

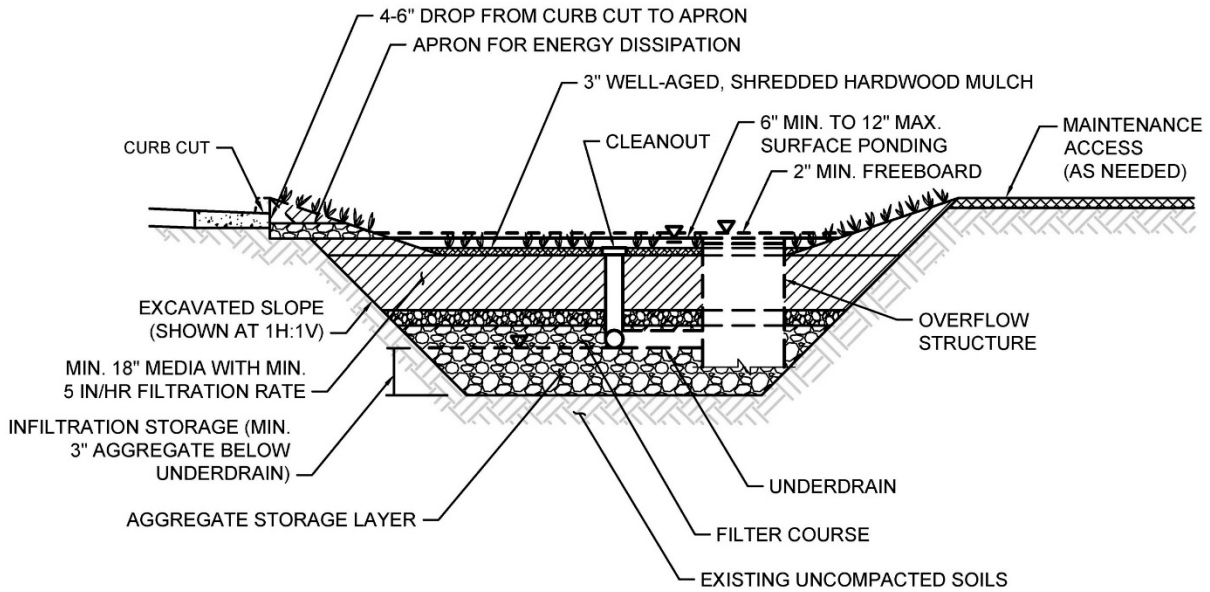

**SECTION A-A'**  
NOT TO SCALE

**Typical plan and Section view of a Biofiltration with Partial Retention BMP**

***Design Adaptations for Project Goals***

**Partial infiltration BMP with biofiltration treatment for storm water pollutant control.** Biofiltration with partial retention can be designed so that a portion of the DCV is infiltrated by providing infiltration storage below the underdrain invert. The infiltration storage depth should be determined by the volume that can be reliably infiltrated within drawdown time limitations. Water discharged through the underdrain is considered biofiltration treatment. Storage provided above the underdrain within surface ponding, media, and aggregate storage is included in the biofiltration treatment volume.

**Integrated storm water flow control and pollutant control configuration.** The system can be designed to provide flow rate and duration control by primarily providing increased surface ponding and/or having a deeper aggregate storage layer. This will allow for significant detention storage, which can be controlled via inclusion of an orifice in an outlet structure at the downstream end of the underdrain.

***Recommended Siting Criteria***

<i>Siting Criteria</i>	<i>Intent/Rationale</i>
<input type="checkbox"/> Placement observes geotechnical recommendations regarding potential hazards (e.g., slope stability, landslides, liquefaction zones) and setbacks (e.g., slopes, foundations, utilities).	Must not negatively impact existing site geotechnical concerns.
<input type="checkbox"/> Selection and design of basin is based on infiltration feasibility criteria and appropriate design infiltration rate (See Appendix C and D).	Must operate as a partial infiltration design and must be supported by drainage area and in-situ infiltration rate feasibility findings.
<input type="checkbox"/> Contributing tributary area shall be $\leq 5$ acres ( $\leq 1$ acre preferred).	Bigger BMPs require additional design features for proper performance.  Contributing tributary area greater than 5 acres may be allowed at the discretion of the City Engineer if the following conditions are met: 1) incorporate design features (e.g. flow spreaders) to minimizing short circuiting of flows in the BMP and 2) incorporate additional design features requested by the

**E.17: PR-1 Biofiltration with Partial Retention**

<i>Siting Criteria</i>	<i>Intent/Rationale</i>
	City Engineer for proper performance of the regional BMP.
<input type="checkbox"/> Finish grade of the facility is $\leq 2\%$ .	Flatter surfaces reduce erosion and channelization within the facility.

**Recommended BMP Component Dimensions**

<i>BMP Component</i>	<i>Dimension</i>	<i>Intent/Rationale</i>
Freeboard	$\geq 12$ inches	Freeboard provides room for head over overflow structures and minimizes risk of uncontrolled surface discharge.
Surface Ponding	$\geq 6$ and $\leq 12$ inches	Surface ponding capacity lowers subsurface storage requirements. Deep surface ponding raises safety concerns.  Surface ponding depth greater than 12 inches (for additional pollutant control or surface outlet structures or flow-control orifices) may be allowed at the discretion of the City Engineer if the following conditions are met: 1) surface ponding depth drawdown time is less than 24 hours; and 2) safety issues and fencing requirements are considered (typically ponding greater than 18" will require a fence and/or flatter side slopes) and 3) potential for elevated clogging risk is considered.
Ponding Area Side Slopes	3H:1V or shallower	Gentler side slopes are safer, less prone to erosion, able to establish vegetation more quickly and easier to maintain.
Mulch	$\geq 3$ inches	Mulch will suppress weeds and maintain moisture for plant growth. Aging mulch kills pathogens and

**E.17: PR-1 Biofiltration with Partial Retention**

<i>BMP Component</i>	<i>Dimension</i>	<i>Intent/Rationale</i>
		weed seeds and allows the beneficial microbes to multiply.
		A deep media layer provides additional filtration and supports plants with deeper roots.
Media Layer	≥ 18 inches	Standard specifications shall be followed.
		For non-standard or proprietary designs, compliance with Appendix F.1 ensures that adequate treatment performance will be provided.
Underdrain Diameter	≥ 6 inches	Smaller diameter underdrains are prone to clogging.
Cleanout Diameter	≥ 6 inches	Properly spaced cleanouts will facilitate underdrain maintenance.

**Design Criteria and Considerations**

Biofiltration with partial retention must meet the following design criteria and considerations. Deviations from the below criteria may be approved at the discretion of the City Engineer if it is determined to be appropriate:

<i>Design Criteria</i>	<i>Intent/Rationale</i>
<b>Surface Ponding</b>	
<input type="checkbox"/> Surface ponding is limited to a 24-hour drawdown time.	Surface ponding limited to 24 hours for plant health. Surface ponding drawdown time greater than 24-hours but less than 96 hours may be allowed at the discretion of the City Engineer if certified by a landscape architect or agronomist.
<b>Vegetation</b>	
<input type="checkbox"/> Plantings are suitable for the climate and	Plants suited to the climate and ponding depth are more likely to survive.

<i>Design Criteria</i>	<i>Intent/Rationale</i>
<p>expected ponding depth. A plant list to aid in selection can be found in Appendix E.26</p>	
<p><input type="checkbox"/> An irrigation system with a connection to water supply should be provided as needed.</p>	<p>Seasonal irrigation might be needed to keep plants healthy.</p>
<b><i>Mulch (Optional)</i></b>	
<p><input type="checkbox"/> A minimum of 3 inches of well-aged, shredded hardwood mulch that has been stockpiled or stored for at least 12 months is provided. Mulch must be non-floating to avoid clogging of overflow structure.</p>	<p>Mulch will suppress weeds and maintain moisture for plant growth. Aging mulch kills pathogens and weed seeds and allows the beneficial microbes to multiply.</p>
<b><i>Media Layer</i></b>	
<p><input type="checkbox"/> Media maintains a minimum filtration rate of 5 in/hr over lifetime of facility. An initial filtration rate of 8 to 12 in/hr is recommended to allow for clogging over time; the initial filtration rate should not exceed 12 inches per hour.</p>	<p>A filtration rate of at least 5 inches per hour allows soil to drain between events, and allows flows to relatively quickly enter the aggregate storage layer, thereby minimizing bypass. The initial rate should be higher than long term target rate to account for clogging over time. However an excessively high initial rate can have a negative impact on treatment performance, therefore an upper limit is needed.</p>
<p><input type="checkbox"/> Media is a minimum 18 inches deep, meeting either of these two media specifications: Section F.3 Bioretention Soil Media (BSM) or specific jurisdictional guidance. Alternatively, for proprietary designs and custom media mixes not meeting the media specifications, the media meets the pollutant treatment performance criteria in Section F.1.</p>	<p>A deep media layer provides additional filtration and supports plants with deeper roots. Standard specifications shall be followed. For non-standard or proprietary designs, compliance with Appendix F.1 ensures that adequate treatment performance will be provided.</p>
<p><input type="checkbox"/> Media surface area is 3% of contributing area times adjusted runoff factor or greater. Unless</p>	<p>Greater surface area to tributary area ratios: a) maximizes volume retention as required by the MS4 Permit and</p>

**E.17: PR-1 Biofiltration with Partial Retention**

<i>Design Criteria</i>	<i>Intent/Rationale</i>
<p>demonstrated that the BMP surface area can be smaller than 3%.</p>	<p>b) decrease loading rates per square foot and therefore increase longevity.</p> <p>Adjusted runoff factor is to account for site design BMPs implemented upstream of the BMP (such as rain barrels, impervious area dispersion, etc.). Refer to Appendix B.2 guidance.</p>
<p><input type="checkbox"/> Where receiving waters are impaired or have a TMDL for nutrients, the system is designed with nutrient sensitive media design (see fact sheet BF-2).</p>	<p>Potential for pollutant export is partly a function of media composition; media design must minimize potential for export of nutrients, particularly where receiving waters are impaired for nutrients.</p>
<b><i>Filter Course Layer</i></b>	
<p><input type="checkbox"/> A filter course is used to prevent migration of fines through layers of the facility. Filter fabric is not used.</p>	<p>Migration of media can cause clogging of the aggregate storage layer void spaces or subgrade. Filter fabric is more likely to clog.</p>
<p><input type="checkbox"/> Filter course is washed and free of fines.</p>	<p>Washing aggregate will help eliminate fines that could clog the facility</p>
<p><input type="checkbox"/> Filter course calculations assessing suitability for particle migration prevention have been completed.</p>	<p>Gradation relationship between layers can evaluate factors (e.g., bridging, permeability, and uniformity) to determine if particle sizing is appropriate or if an intermediate layer is needed.</p>
<b><i>Aggregate Storage Layer</i></b>	
<p><input type="checkbox"/> Class 2 Permeable per Caltrans specification 68-1.025 is recommended for the storage layer. Washed, open-graded crushed rock may be used, however a 4-6 inch washed pea gravel filter course layer at the top of the crushed rock is required.</p>	<p>Washing aggregate will help eliminate fines that could clog the aggregate storage layer void spaces or subgrade.</p>
<p><input type="checkbox"/> Maximum aggregate storage layer depth below the underdrain invert is determined based on the infiltration storage volume that will infiltrate within a 36-hour drawdown time.</p>	<p>A maximum drawdown time is needed for vector control and to facilitate providing storm water storage for the next storm event.</p>

<i>Design Criteria</i>	<i>Intent/Rationale</i>
<b><i>Inflow, Underdrain, and Outflow Structures</i></b>	
<input type="checkbox"/> Inflow, underdrains and outflow structures are accessible for inspection and maintenance.	Maintenance will prevent clogging and ensure proper operation of the flow control structures.
<input type="checkbox"/> Inflow velocities are limited to 3 ft/s or less or use energy dissipation methods. (e.g., riprap, level spreader) for concentrated inflows.	High inflow velocities can cause erosion, scour and/or channeling.
<input type="checkbox"/> Curb cut inlets are at least 12 inches wide, have a 4-6 inch reveal (drop) and an apron and energy dissipation as needed.	Inlets must not restrict flow and apron prevents blockage from vegetation as it grows in. Energy dissipation prevents erosion.
<input type="checkbox"/> Underdrain outlet elevation should be a minimum of 3 inches above the bottom elevation of the aggregate storage layer.	A minimal separation from subgrade or the liner lessens the risk of fines entering the underdrain and can improve hydraulic performance by allowing perforations to remain unblocked.
<input type="checkbox"/> Minimum underdrain diameter is 6 inches.	Smaller diameter underdrains are prone to clogging.
<input type="checkbox"/> Underdrains are made of slotted, PVC pipe conforming to ASTM D 3034 or equivalent or corrugated, HDPE pipe conforming to AASHTO 252M or equivalent.	Slotted underdrains provide greater intake capacity, clog resistant drainage, and reduced entrance velocity into the pipe, thereby reducing the chances of solids migration.
<input type="checkbox"/> An underdrain cleanout with a minimum 6-inch diameter and lockable cap is placed every 250 to 300 feet as required based on underdrain length.	Properly spaced cleanouts will facilitate underdrain maintenance.
<input type="checkbox"/> Overflow is safely conveyed to a downstream storm drain system or discharge point. Size overflow structure to pass 100-year peak flow for on-line infiltration basins and water quality peak flow for off-line basins.	Planning for overflow lessens the risk of property damage due to flooding.

***Nutrient Sensitive Media Design***

To design biofiltration with partial retention with underdrain for storm water pollutant control only (no flow control required), the following steps should be taken:

**Conceptual Design and Sizing Approach for Storm Water Pollutant Control Only**

To design biofiltration with partial retention and an underdrain for storm water pollutant control only (no flow control required), the following steps should be taken:

1. Verify that siting and design criteria have been met, including placement requirements, contributing tributary area, maximum side and finish grade slopes, and the recommended media surface area tributary ratio.
2. Calculate the DCV per Appendix B based on expected site design runoff for tributary areas.
3. Generalized sizing procedure is presented in Appendix B.5. The surface ponding should be verified to have a maximum 24-hour drawdown time.

**Conceptual Design and Sizing Approach when Storm Water Flow Control is Applicable**

Control of flow rates and/or durations will typically require significant surface ponding and/or aggregate storage volumes, and therefore the following steps should be taken prior to determination of storm water pollutant control design. Pre-development and allowable post-project flow rates and durations should be determined as discussed in Chapter 6 of the manual.

1. Verify that siting and design criteria have been met, including placement requirements, contributing tributary area, maximum side and finish grade slopes, and the recommended media surface area tributary ratio.
2. Iteratively determine the facility footprint area, surface ponding and/or aggregate storage layer depth required to provide detention and/or infiltration storage to reduce flow rates and durations to allowable limits. Flow rates and durations can be controlled from detention storage by altering outlet structure orifice size(s) and/or water control levels. Multi-level orifices can be used within an outlet structure to control the full range of flows.
3. If biofiltration with partial retention cannot fully provide the flow rate and duration control required by this manual, an upstream or downstream structure with significant storage volume such as an underground vault can be used to provide remaining controls.
4. After biofiltration with partial retention has been designed to meet flow control requirements, calculations must be completed to verify if storm water pollutant control requirements to treat the DCV have been met.

**Maintenance Overview**

**Normal Expected Maintenance.** Biofiltration with partial retention requires routine maintenance to: remove accumulated materials such as sediment, trash or debris; maintain vegetation health; maintain infiltration capacity of the media layer; replenish mulch; and maintain integrity of side slopes, inlets, energy dissipators, and outlets. A summary table of standard inspection and maintenance indicators is provided within this Fact Sheet.

**Non-Standard Maintenance or BMP Failure.** If any of the following scenarios are observed, the



## E.17: PR-1 Biofiltration with Partial Retention

BMP is not performing as intended to protect downstream waterways from pollution and/or erosion. Corrective maintenance, increased inspection and maintenance, BMP replacement, or a different BMP type will be required.

- The BMP is not drained between storm events. Surface ponding longer than approximately 24 hours following a storm event may be detrimental to vegetation health, and surface ponding longer than approximately 96 hours following a storm event poses a risk of vector (mosquito) breeding. Poor drainage can result from clogging of the media layer, filter course, aggregate storage layer, underdrain, or outlet structure. The specific cause of the drainage issue must be determined and corrected.
- Sediment, trash, or debris accumulation greater than 25% of the surface ponding volume within one month. This means the load from the tributary drainage area is too high, reducing BMP function or clogging the BMP. This would require pretreatment measures within the tributary area draining to the BMP to intercept the materials. Pretreatment components, especially for sediment, will extend the life of components that are more expensive to replace such as media, filter course, and aggregate layers.
- Erosion due to concentrated storm water runoff flow that is not readily corrected by adding erosion control blankets, adding stone at flow entry points, or minor re-grading to restore proper drainage according to the original plan. If the issue is not corrected by restoring the BMP to the original plan and grade, the City Engineer shall be contacted prior to any additional repairs or reconstruction.

**Other Special Considerations.** Biofiltration with partial retention is a vegetated structural BMP. Vegetated structural BMPs that are constructed in the vicinity of, or connected to, an existing jurisdictional water or wetland could inadvertently result in creation of expanded waters or wetlands. As such, vegetated structural BMPs have the potential to come under the jurisdiction of the United States Army Corps of Engineers, SDRWQCB, California Department of Fish and Wildlife, or the United States Fish and Wildlife Service. This could result in the need for specific resource agency permits and costly mitigation to perform maintenance of the structural BMP. Along with proper placement of a structural BMP, routine maintenance is key to preventing this scenario.

**Sediment Loading.** Consider the effects of BMP design and tributary area land uses on the clogging potential of the BMP. Complete the sediment loading analysis included in Appendix E.27.

**Summary of Standard Inspection and Maintenance**

The property owner is responsible to ensure inspection, operation and maintenance of permanent BMPs on their property unless responsibility has been formally transferred to an agency, community facilities district, homeowners association, property owners association, or other special district.

Maintenance frequencies listed in this table are average/typical frequencies. Actual maintenance needs are site-specific, and maintenance may be required more frequently. Maintenance must be performed whenever needed, based on maintenance indicators presented in this table. The BMP owner is responsible for conducting regular inspections to see when maintenance is needed based on the maintenance indicators. During the first year of operation of a structural BMP, inspection is recommended at least once prior to August 31 and then monthly from September through May. Inspection during a storm event is also recommended. After the initial period of frequent inspections, the minimum inspection and maintenance frequency can be determined based on the results of the first year inspections.

Threshold/Indicator	Maintenance Action	Typical Maintenance Frequency
Accumulation of sediment, litter, or debris	Remove and properly dispose of accumulated materials, without damage to the vegetation or compaction of the media layer.	<ul style="list-style-type: none"> <li>• Inspect monthly. If the BMP is 25% full* or more in one month, increase inspection frequency to monthly plus after every 0.1-inch or larger storm event.</li> <li>• Remove any accumulated materials found at each inspection.</li> </ul>
Obstructed inlet or outlet structure	Clear blockage.	<ul style="list-style-type: none"> <li>• Inspect monthly and after every 0.5-inch or larger storm event.</li> <li>• Remove any accumulated materials found at each inspection.</li> </ul>
Damage to structural components such as weirs, inlet or outlet structures	Repair or replace as applicable.	<ul style="list-style-type: none"> <li>• Inspect annually.</li> <li>• Maintain when needed.</li> </ul>
Poor vegetation establishment	Re-seed, re-plant, or re-establish vegetation per original plans.	<ul style="list-style-type: none"> <li>• Inspect monthly.</li> <li>• Maintain when needed.</li> </ul>

**E.17: PR-1 Biofiltration with Partial Retention**

Threshold/Indicator	Maintenance Action	Typical Maintenance Frequency
Dead or diseased vegetation	Remove dead or diseased vegetation, re-seed, re-plant, or re-establish vegetation per original plans.	<ul style="list-style-type: none"> <li>• Inspect monthly.</li> <li>• Maintain when needed.</li> </ul>
Overgrown vegetation	Mow or trim as appropriate.	<ul style="list-style-type: none"> <li>• Inspect monthly.</li> <li>• Maintain when needed.</li> </ul>
2/3 of mulch has decomposed, or mulch has been removed	Remove decomposed fraction and top off with fresh mulch to a total depth of 3 inches.	<ul style="list-style-type: none"> <li>• Inspect monthly.</li> <li>• Replenish mulch annually, or more frequently when needed based on inspection.</li> </ul>
Erosion due to concentrated irrigation flow	Repair/re-seed/re-plant eroded areas and adjust the irrigation system.	<ul style="list-style-type: none"> <li>• Inspect monthly.</li> <li>• Maintain when needed.</li> </ul>
Erosion due to concentrated storm water runoff flow	Repair/re-seed/re-plant eroded areas, and make appropriate corrective measures such as adding erosion control blankets, adding stone at flow entry points, or minor re-grading to restore proper drainage according to the original plan. If the issue is not corrected by restoring the BMP to the original plan and grade, the City Engineer shall be contacted prior to any additional repairs or reconstruction.	<ul style="list-style-type: none"> <li>• Inspect after every 0.5-inch or larger storm event. If erosion due to storm water flow has been observed, increase inspection frequency to after every 0.1-inch or larger storm event.</li> <li>• Maintain when needed. If the issue is not corrected by restoring the BMP to the original plan and grade, the City Engineer shall be contacted prior to any additional repairs or reconstruction.</li> </ul>

E.17: PR-1 Biofiltration with Partial Retention

Threshold/Indicator	Maintenance Action	Typical Maintenance Frequency
<p>Standing water in BMP for longer than 24 hours following a storm event</p> <p>Surface ponding longer than approximately 24 hours following a storm event may be detrimental to vegetation health</p>	<p>Make appropriate corrective measures such as adjusting irrigation system, removing obstructions of debris or invasive vegetation, clearing underdrains, or repairing/replacing clogged or compacted soils.</p>	<ul style="list-style-type: none"> <li>• Inspect monthly and after every 0.5-inch or larger storm event. If standing water is observed, increase inspection frequency to after every 0.1-inch or larger storm event.</li> <li>• Maintain when needed.</li> </ul>
<p>Presence of mosquitos/larvae</p> <p>For images of egg rafts, larva, pupa, and adult mosquitos, see <a href="http://www.mosquito.org/biology">http://www.mosquito.org/biology</a></p>	<p>If mosquitos/larvae are observed: first, immediately remove any standing water by dispersing to nearby landscaping; second, make corrective measures as applicable to restore BMP drainage to prevent standing water.</p> <p>If mosquitos persist following corrective measures to remove standing water, or if the BMP design does not meet the 96-hour drawdown criteria due to release rates controlled by an orifice installed on the underdrain, the City Engineer shall be contacted to determine a solution. A different BMP type, or a Vector Management Plan prepared with concurrence from the County of San Diego Department of Environmental Health, may be required.</p>	<ul style="list-style-type: none"> <li>• Inspect monthly and after every 0.5-inch or larger storm event. If mosquitos are observed, increase inspection frequency to after every 0.1-inch or larger storm event.</li> <li>• Maintain when needed.</li> </ul>

**E.17: PR-1 Biofiltration with Partial Retention**

Threshold/Indicator	Maintenance Action	Typical Maintenance Frequency
Underdrain clogged	Clear blockage.	Inspect if standing water is observed for longer than 24-96 hours following a storm event. Maintain when needed.

## E.18 BF-1 Biofiltration



*Location: 43<sup>rd</sup> Street and Logan Avenue, San Diego, California*

---

**MS4 Permit Category**

---

Biofiltration

---

**Manual Category**

---

Biofiltration

---

**Applicable Performance Standard**

---

Pollutant Control

Flow Control

---

**Primary Benefits**

---

Treatment

Volume Reduction (Incidental)

Peak Flow Attenuation (Optional)

---

**Description**



---

Biofiltration (Bioretention with underdrain) facilities are vegetated surface water systems that filter water through vegetation, and soil or engineered media prior to discharge via underdrain or overflow to the downstream conveyance system. Bioretention with underdrain facilities are commonly incorporated into the site within parking lot landscaping, along roadsides, and in open spaces. Because these types of facilities have limited or no infiltration, they are typically designed to provide enough hydraulic head to move flows through the underdrain connection to the storm drain system. Treatment is achieved through filtration, sedimentation, sorption, biochemical processes and plant uptake.

Typical bioretention with underdrain components include:

- Inflow distribution mechanisms (e.g, perimeter flow spreader or filter strips)
- Energy dissipation mechanism for concentrated inflows (e.g., splash blocks or riprap)
- Shallow surface ponding for captured flows
- Side slope and basin bottom vegetation selected based on expected climate and ponding depth
- Non-floating mulch layer (Optional)
- Media layer (planting mix or engineered media) capable of supporting vegetation growth
- Filter course layer consisting of aggregate to prevent the migration of fines into uncompacted native soils or the aggregate storage layer
- Aggregate storage layer with underdrain(s)

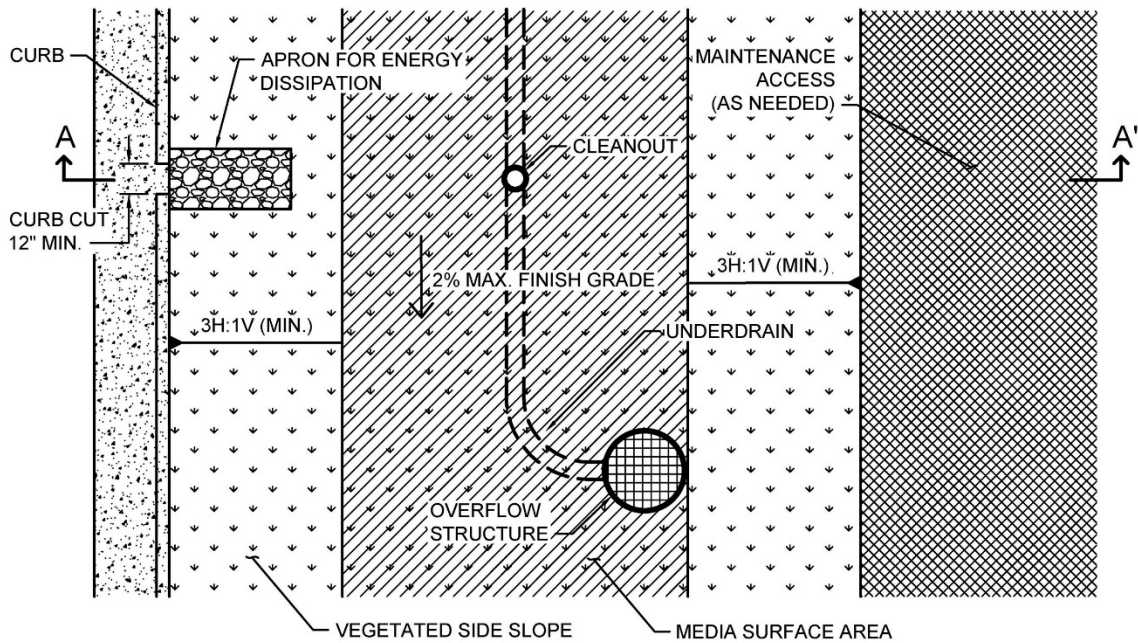
- Impermeable liner or uncompacted native soils at the bottom of the facility
- Overflow structure



**PLAN**  
NOT TO SCALE

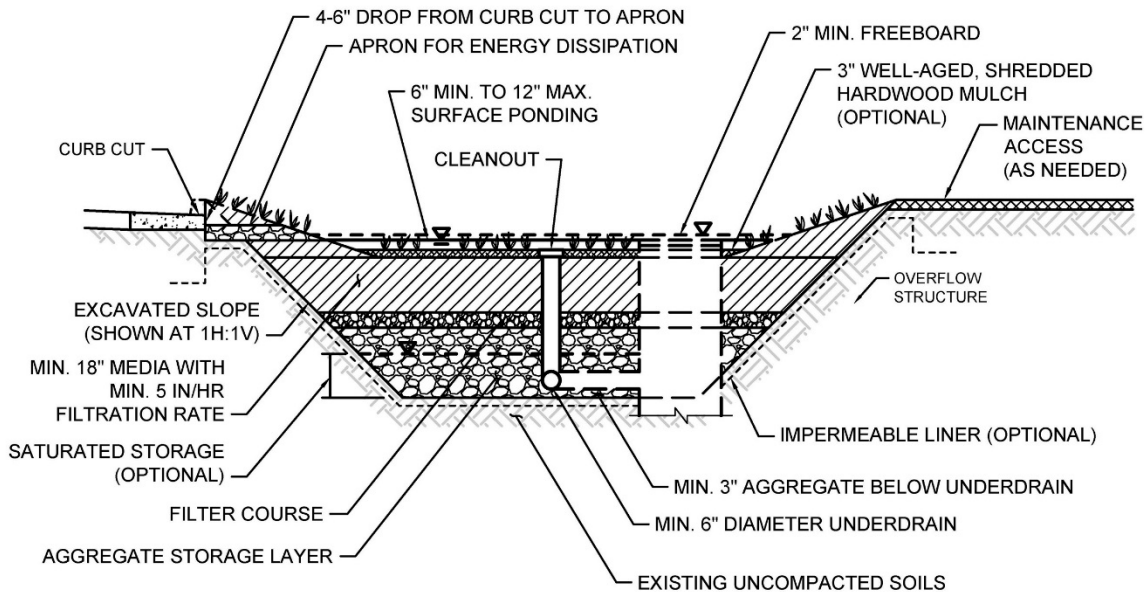

**SECTION A-A'**  
NOT TO SCALE

Typical plan and Section view of a Biofiltration BMP

**Design Adaptations for Project Goals**

**Biofiltration Treatment BMP for storm water pollutant control.** The system is lined or un-lined to provide incidental infiltration, and an underdrain is provided at the bottom to carry away filtered runoff. This configuration is considered to provide biofiltration treatment via flow through the media layer. Storage provided above the underdrain within surface ponding, media, and aggregate storage is considered included in the biofiltration treatment volume. Saturated storage within the aggregate storage layer can be added to this design by raising the underdrain above the bottom of the aggregate storage layer or via an internal weir structure designed to maintain a specific water level elevation.

**Integrated storm water flow control and pollutant control configuration.** The system can be designed to provide flow rate and duration control by primarily providing increased surface ponding and/or having a deeper aggregate storage layer above the underdrain. This will allow for significant detention storage, which can be controlled via inclusion of an outlet structure at the downstream end of the underdrain.

**Recommended Siting Criteria**

<i>Siting Criteria</i>	<i>Intent/Rationale</i>
<input type="checkbox"/> Placement observes geotechnical recommendations regarding potential hazards (e.g., slope stability, landslides, liquefaction zones) and setbacks (e.g., slopes, foundations, utilities).	Must not negatively impact existing site geotechnical concerns.
<input type="checkbox"/> An impermeable liner or other hydraulic restriction layer is included if site constraints indicate that infiltration or lateral flows should not be allowed.	Lining prevents storm water from impacting groundwater and/or sensitive environmental or geotechnical features. Incidental infiltration, when allowable, can aid in pollutant removal and groundwater recharge.
<input type="checkbox"/> Contributing tributary area shall be $\leq 5$ acres ( $\leq 1$ acre preferred).	Bigger BMPs require additional design features for proper performance. Contributing tributary area greater than 5 acres may be allowed at the discretion of the City Engineer if the following conditions are met: 1) incorporate design features (e.g. flow spreaders) to minimizing short circuiting of flows in



<i>Siting Criteria</i>	<i>Intent/Rationale</i>
	the BMP and 2) incorporate additional design features requested by the City Engineer for proper performance of the regional BMP.
<input type="checkbox"/> Finish grade of the facility is $\leq 2\%$ .	Flatter surfaces reduce erosion and channelization within the facility.

**Recommended BMP Component and Dimensions**

<i>BMP Component</i>	<i>Dimension</i>	<i>Intent/Rationale</i>
Freeboard	$\geq 12$ inches	Freeboard provides room for head over overflow structures and minimizes risk of uncontrolled surface discharge.
		Surface ponding capacity lowers subsurface storage requirements. Deep surface ponding raises safety concerns.
Surface Ponding	$\geq 6$ and $\leq 12$ inches	Surface ponding depth greater than 12 inches (for additional pollutant control or surface outlet structures or flow-control orifices) may be allowed at the discretion of the City Engineer if the following conditions are met: 1) surface ponding depth drawdown time is less than 24 hours; and 2) safety issues and fencing requirements are considered (typically ponding greater than 18" will require a fence and/or flatter side slopes) and 3) potential for elevated clogging risk is considered.

<i>BMP Component</i>	<i>Dimension</i>	<i>Intent/Rationale</i>
Ponding Area Side Slopes	3H:1V or shallower	Gentler side slopes are safer, less prone to erosion, able to establish vegetation more quickly and easier to maintain.
Mulch	≥ 3 inches	Mulch will suppress weeds and maintain moisture for plant growth. Aging mulch kills pathogens and weed seeds and allows the beneficial microbes to multiply.
Media Layer	≥ 18 inches	A deep media layer provides additional filtration and supports plants with deeper roots. Standard specifications shall be followed. For non-standard or proprietary designs, compliance with F.1 ensures that adequate treatment performance will be provided.
Underdrain Diameter	≥ 6 inches	Smaller diameter underdrains are prone to clogging.
Cleanout Diameter	≥ 6 inches	Properly spaced cleanouts will facilitate underdrain maintenance.

**Design Criteria and Considerations**

Bioretention with underdrain must meet the following design criteria. Deviations from the below criteria may be approved at the discretion of the City Engineer if it is determined to be appropriate:

<i>Design Criteria</i>	<i>Intent/Rationale</i>
<b>Surface Ponding</b>	
<input type="checkbox"/> Surface ponding is limited to a 24-hour drawdown time.	Surface ponding limited to 24 hours for plant health. Surface ponding drawdown time greater than 24-hours but less than 96 hours may be allowed at the discretion of the City Engineer if certified by a landscape architect or agronomist.
<b>Vegetation</b>	
<input type="checkbox"/> Plantings are suitable for the climate and expected ponding depth. A plant list to aid in selection can be found in Appendix E.26.	Plants suited to the climate and ponding depth are more likely to survive.
<input type="checkbox"/> An irrigation system with a connection to water supply should be provided as needed.	Seasonal irrigation might be needed to keep plants healthy.
<b>Mulch (Optional)</b>	
<input type="checkbox"/> A minimum of 3 inches of well-aged, shredded hardwood mulch that has been stockpiled or stored for at least 12 months is provided.	Mulch will suppress weeds and maintain moisture for plant growth. Aging mulch kills pathogens and weed seeds and allows the beneficial microbes to multiply.
<b>Media Layer</b>	
<input type="checkbox"/> Media maintains a minimum filtration rate of 5 in/hr over lifetime of facility. An initial filtration rate of 8 to 12 in/hr is recommended to allow for clogging over time; the initial filtration rate should not exceed 12 inches per hour.	A filtration rate of at least 5 inches per hour allows soil to drain between events. The initial rate should be higher than long term target rate to account for clogging over time. However an excessively high initial rate can have a negative impact on treatment performance, therefore an upper limit is needed.

<i>Design Criteria</i>	<i>Intent/Rationale</i>
<p>Media is a minimum 18 inches deep, meeting either of these two media specifications:</p> <p><input type="checkbox"/> Section F.3 Bioretention Soil Media (BSM) or specific jurisdictional guidance.</p> <p><input type="checkbox"/> Alternatively, for proprietary designs and custom media mixes not meeting the media specifications, the media meets the pollutant treatment performance criteria in Section F.1.</p>	<p>A deep media layer provides additional filtration and supports plants with deeper roots.</p> <p>Standard specifications shall be followed.</p> <p>For non-standard or proprietary designs, compliance with F.1 ensures that adequate treatment performance will be provided.</p>
<p><input type="checkbox"/> Media surface area is 3% of contributing area times adjusted runoff factor or greater. Unless demonstrated that the BMP surface area can be smaller than 3%.</p>	<p>Greater surface area to tributary area ratios: a) maximizes volume retention as required by the MS4 Permit and b) decrease loading rates per square foot and therefore increase longevity.</p> <p>Adjusted runoff factor is to account for site design BMPs implemented upstream of the BMP (such as rain barrels, impervious area dispersion, etc.). Refer to Appendix B.2 guidance.</p>
<p><input type="checkbox"/> Where receiving waters are impaired or have a TMDL for nutrients, the system is designed with nutrient sensitive media design (see fact sheet BF-2).</p>	<p>Potential for pollutant export is partly a function of media composition; media design must minimize potential for export of nutrients, particularly where receiving waters are impaired for nutrients.</p>
<i>Filter Course Layer</i>	
<p><input type="checkbox"/> A filter course is used to prevent migration of fines through layers of the facility. Filter fabric is not used.</p>	<p>Migration of media can cause clogging of the aggregate storage layer void spaces or subgrade. Filter fabric is more likely to clog.</p>
<p><input type="checkbox"/> Filter course is washed and free of fines.</p>	<p>Washing aggregate will help eliminate fines that could clog the facility and impede infiltration.</p>

<i>Design Criteria</i>	<i>Intent/Rationale</i>
<input type="checkbox"/> Filter course calculations assessing suitability for particle migration prevention have been completed.	Gradation relationship between layers can evaluate factors (e.g., bridging, permeability, and uniformity) to determine if particle sizing is appropriate or if an intermediate layer is needed.
<i>Aggregate Storage Layer</i>	
<input type="checkbox"/> Class 2 Permeable per Caltrans specification 68-1.025 is recommended for the storage layer. Washed, open-graded crushed rock may be used, however a 4-6 inch washed pea gravel filter course layer at the top of the crushed rock is required.	Washing aggregate will help eliminate fines that could clog the aggregate storage layer void spaces or subgrade.
<input type="checkbox"/> The depth of aggregate provided (12-inch typical) and storage layer configuration is adequate for providing conveyance for underdrain flows to the outlet structure.	Proper storage layer configuration and underdrain placement will minimize facility drawdown time.
<i>Inflow, Underdrain, and Outflow Structures</i>	
<input type="checkbox"/> Inflow, underdrains and outflow structures are accessible for inspection and maintenance.	Maintenance will prevent clogging and ensure proper operation of the flow control structures.
<input type="checkbox"/> Inflow velocities are limited to 3 ft/s or less or use energy dissipation methods. (e.g., riprap, level spreader) for concentrated inflows.	High inflow velocities can cause erosion, scour and/or channeling.
<input type="checkbox"/> Curb cut inlets are at least 12 inches wide, have a 4-6 inch reveal (drop) and an apron and energy dissipation as needed.	Inlets must not restrict flow and apron prevents blockage from vegetation as it grows in. Energy dissipation prevents erosion.
<input type="checkbox"/> Underdrain outlet elevation should be a minimum of 3 inches above the bottom elevation of the aggregate storage layer.	A minimal separation from subgrade or the liner lessens the risk of fines entering the underdrain and can improve hydraulic performance by allowing perforations to remain unblocked.
<input type="checkbox"/> Minimum underdrain diameter is 6 inches.	Smaller diameter underdrains are prone to clogging.
<input type="checkbox"/> Underdrains are made of slotted, PVC pipe conforming to ASTM D 3034 or equivalent or	Slotted underdrains provide greater intake capacity, clog resistant drainage,

<i>Design Criteria</i>	<i>Intent/Rationale</i>
corrugated, HDPE pipe conforming to AASHTO 252M or equivalent.	and reduced entrance velocity into the pipe, thereby reducing the chances of solids migration.
<input type="checkbox"/> An underdrain cleanout with a minimum 6-inch diameter and lockable cap is placed every 250 to 300 feet as required based on underdrain length.	Properly spaced cleanouts will facilitate underdrain maintenance.
<input type="checkbox"/> Overflow is safely conveyed to a downstream storm drain system or discharge point. Size overflow structure to pass 100-year peak flow for on-line infiltration basins and water quality peak flow for off-line basins.	Planning for overflow lessens the risk of property damage due to flooding.

#### **Conceptual Design and Sizing Approach for Storm Water Pollutant Control Only**

To design bioretention with underdrain for storm water pollutant control only (no flow control required), the following steps should be taken:

1. Verify that siting and design criteria have been met, including placement requirements, contributing tributary area, maximum side and finish grade slopes, and the recommended media surface area tributary ratio.
2. Calculate the DCV per Appendix B based on expected site design runoff for tributary areas.
3. Use the sizing worksheet presented in Appendix B.5 to size biofiltration BMPs.

#### **Conceptual Design and Sizing Approach when Storm Water Flow Control is Applicable**

Control of flow rates and/or durations will typically require significant surface ponding and/or aggregate storage volumes, and therefore the following steps should be taken prior to determination of storm water pollutant control design. Pre-development and allowable post-project flow rates and durations should be determined as discussed in Chapter 6 of the manual.

1. Verify that siting and design criteria have been met, including placement requirements, contributing tributary area, maximum side and finish grade slopes, and the recommended media surface area tributary ratio.
2. Iteratively determine the facility footprint area, surface ponding and/or aggregate storage layer depth required to provide detention storage to reduce flow rates and durations to allowable limits. Flow rates and durations can be controlled from detention storage by altering outlet structure orifice size(s) and/or water control levels. Multi-level orifices can be used within an

outlet structure to control the full range of flows.

3. If bioretention with underdrain cannot fully provide the flow rate and duration control required by this manual, an upstream or downstream structure with significant storage volume such as an underground vault can be used to provide remaining controls.
4. After bioretention with underdrain has been designed to meet flow control requirements, calculations must be completed to verify if storm water pollutant control requirements to treat the DCV have been met.

### **Maintenance Overview**

**Normal Expected Maintenance.** Biofiltration requires routine maintenance to: remove accumulated materials such as sediment, trash or debris; maintain vegetation health; maintain infiltration capacity of the media layer; replenish mulch; and maintain integrity of side slopes, inlets, energy dissipators, and outlets. A summary table of standard inspection and maintenance indicators is provided within this Fact Sheet.

**Non-Standard Maintenance or BMP Failure.** If any of the following scenarios are observed, the BMP is not performing as intended to protect downstream waterways from pollution and/or erosion. Corrective maintenance, increased inspection and maintenance, BMP replacement, or a different BMP type will be required.

- The BMP is not drained between storm events. Surface ponding longer than approximately 24 hours following a storm event may be detrimental to vegetation health, and surface ponding longer than approximately 96 hours following a storm event poses a risk of vector (mosquito) breeding. Poor drainage can result from clogging of the media layer, filter course, aggregate storage layer, underdrain, or outlet structure. The specific cause of the drainage issue must be determined and corrected.
- Sediment, trash, or debris accumulation greater than 25% of the surface ponding volume within one month. This means the load from the tributary drainage area is too high, reducing BMP function or clogging the BMP. This would require pretreatment measures within the tributary area draining to the BMP to intercept the materials. Pretreatment components, especially for sediment, will extend the life of components that are more expensive to replace such as media, filter course, and aggregate layers.
- Erosion due to concentrated storm water runoff flow that is not readily corrected by adding erosion control blankets, adding stone at flow entry points, or minor re-grading to restore proper drainage according to the original plan. If the issue is not corrected by restoring the BMP to the original plan and grade, the City Engineer shall be contacted prior to any additional repairs or reconstruction.

**Other Special Considerations.** Biofiltration is a vegetated structural BMP. Vegetated structural BMPs that are constructed in the vicinity of, or connected to, an existing jurisdictional water or wetland could inadvertently result in creation of expanded waters or wetlands. As such, vegetated

structural BMPs have the potential to come under the jurisdiction of the United States Army Corps of Engineers, SDRWQCB, California Department of Fish and Wildlife, or the United States Fish and Wildlife Service. This could result in the need for specific resource agency permits and costly mitigation to perform maintenance of the structural BMP. Along with proper placement of a structural BMP, routine maintenance is key to preventing this scenario.

**Sediment Loading.** Consider the effects of BMP design and tributary area land uses on the clogging potential of the BMP. Complete the sediment loading analysis included in Appendix E.27.



**Summary of Standard Inspection and Maintenance**

The property owner is responsible to ensure inspection, operation and maintenance of permanent BMPs on their property unless responsibility has been formally transferred to an agency, community facilities district, homeowners association, property owners association, or other special district.

Maintenance frequencies listed in this table are average/typical frequencies. Actual maintenance needs are site-specific, and maintenance may be required more frequently. Maintenance must be performed whenever needed, based on maintenance indicators presented in this table. The BMP owner is responsible for conducting regular inspections to see when maintenance is needed based on the maintenance indicators. During the first year of operation of a structural BMP, inspection is recommended at least once prior to August 31 and then monthly from September through May. Inspection during a storm event is also recommended. After the initial period of frequent inspections, the minimum inspection and maintenance frequency can be determined based on the results of the first year inspections.

Threshold/Indicator	Maintenance Action	Typical Maintenance Frequency
Accumulation of sediment, litter, or debris	Remove and properly dispose of accumulated materials, without damage to the vegetation or compaction of the media layer.	<ul style="list-style-type: none"> <li>• Inspect monthly. If the BMP is 25% full* or more in one month, increase inspection frequency to monthly plus after every 0.1-inch or larger storm event.</li> <li>• Remove any accumulated materials found at each inspection.</li> </ul>
Obstructed inlet or outlet structure	Clear blockage.	<ul style="list-style-type: none"> <li>• Inspect monthly and after every 0.5-inch or larger storm event.</li> <li>• Remove any accumulated materials found at each inspection.</li> </ul>
Damage to structural components such as weirs, inlet or outlet structures	Repair or replace as applicable	<ul style="list-style-type: none"> <li>• Inspect annually.</li> <li>• Maintain when needed.</li> </ul>
Poor vegetation establishment	Re-seed, re-plant, or re-establish vegetation per original plans.	<ul style="list-style-type: none"> <li>• Inspect monthly.</li> <li>• Maintain when needed.</li> </ul>

Threshold/Indicator	Maintenance Action	Typical Maintenance Frequency
Dead or diseased vegetation	Remove dead or diseased vegetation, re-seed, re-plant, or re-establish vegetation per original plans.	<ul style="list-style-type: none"> <li>• Inspect monthly.</li> <li>• Maintain when needed.</li> </ul>
Overgrown vegetation	Mow or trim as appropriate.	<ul style="list-style-type: none"> <li>• Inspect monthly.</li> <li>• Maintain when needed.</li> </ul>
2/3 of mulch has decomposed, or mulch has been removed	Remove decomposed fraction and top off with fresh mulch to a total depth of 3 inches.	<ul style="list-style-type: none"> <li>• Inspect monthly.</li> <li>• Replenish mulch annually, or more frequently when needed based on inspection.</li> </ul>
Erosion due to concentrated irrigation flow	Repair/re-seed/re-plant eroded areas and adjust the irrigation system.	<ul style="list-style-type: none"> <li>• Inspect monthly.</li> <li>• Maintain when needed.</li> </ul>
Erosion due to concentrated storm water runoff flow	Repair/re-seed/re-plant eroded areas, and make appropriate corrective measures such as adding erosion control blankets, adding stone at flow entry points, or minor re-grading to restore proper drainage according to the original plan. If the issue is not corrected by restoring the BMP to the original plan and grade, the City Engineer shall be contacted prior to any additional repairs or reconstruction.	<ul style="list-style-type: none"> <li>• Inspect after every 0.5-inch or larger storm event. If erosion due to storm water flow has been observed, increase inspection frequency to after every 0.1-inch or larger storm event.</li> <li>• Maintain when needed. If the issue is not corrected by restoring the BMP to the original plan and grade, the City Engineer shall be contacted prior to any additional repairs or reconstruction.</li> </ul>
Standing water in BMP for longer than 24 hours following a storm event Surface ponding longer than approximately 24 hours following a storm event may be detrimental to vegetation health	Make appropriate corrective measures such as adjusting irrigation system, removing obstructions of debris or invasive vegetation, clearing underdrains, or repairing/replacing clogged or compacted soils.	<ul style="list-style-type: none"> <li>• Inspect monthly and after every 0.5-inch or larger storm event. If standing water is observed, increase inspection frequency to after every 0.1-inch or larger storm event.</li> <li>• Maintain when needed.</li> </ul>

Threshold/Indicator	Maintenance Action	Typical Maintenance Frequency
<p>Presence of mosquitos/larvae</p> <p>For images of egg rafts, larva, pupa, and adult mosquitos, see <a href="http://www.mosquito.org/biology">http://www.mosquito.org/biology</a></p>	<p>If mosquitos/larvae are observed: first, immediately remove any standing water by dispersing to nearby landscaping; second, make corrective measures as applicable to restore BMP drainage to prevent standing water.</p> <p>If mosquitos persist following corrective measures to remove standing water, or if the BMP design does not meet the 96-hour drawdown criteria due to release rates controlled by an orifice installed on the underdrain, the City Engineer shall be contacted to determine a solution. A different BMP type, or a Vector Management Plan prepared with concurrence from the County of San Diego Department of Environmental Health, may be required.</p>	<ul style="list-style-type: none"> <li>• Inspect monthly and after every 0.5-inch or larger storm event. If mosquitos are observed, increase inspection frequency to after every 0.1-inch or larger storm event.</li> <li>• Maintain when needed.</li> </ul>
<p>Underdrain clogged</p>	<p>Clear blockage.</p>	<p>Inspect if standing water is observed for longer than 24-96 hours following a storm event.</p> <p>Maintain when needed.</p>

“25% full” is defined as ¼ of the depth from the design bottom elevation to the crest of the outflow structure (e.g., if the height to the outflow opening is 12 inches from the bottom elevation, then the materials must be removed when there is 3 inches of accumulation – this should be marked on the outflow structure).

## E.19 BF-2 Nutrient Sensitive Media Design

Some studies of biofiltration BMPs have observed export of nutrients, particularly inorganic nitrogen (nitrate and nitrite) and dissolved phosphorus. This has been observed to be a short-lived phenomenon in some studies or a long term issue in some studies. The composition of the soil media, including the chemistry of individual elements is believed to be an important factor in the potential for nutrient export. Organic amendments, often compost, have been identified as the most likely source of nutrient export. The quality and stability of organic amendments can vary widely.

The biofiltration media specifications contained in the County of San Diego Low Impact Development Handbook: Appendix G -Bioretention Soil Specification (June 2014, unless superseded by more recent edition) and the City of San Diego Low Impact Development Design Manual (page B-18) (July 2011, unless superseded by more recent edition) were developed with consideration of the potential for nutrient export. These specifications include criteria for individual component characteristics and quality in order to control the overall quality of the blended mixes. As of the publication of this manual, the June 2014 County of San Diego specifications provide more detail regarding mix design and quality control.

The City and County specifications noted above were developed for general purposes to meet permeability and treatment goals. In cases where the BMP discharges to receiving waters with nutrient impairments or nutrient TMDLs, the biofiltration media should be designed with the specific goal of minimizing the potential for export of nutrients from the media. Therefore, in addition to adhering to the City or County media specifications, the following guidelines should be followed:

### 1. Select plant palette to minimize plant nutrient needs

A landscape architect or agronomist should be consulted to select a plant palette that minimizes nutrient needs. Utilizing plants with low nutrient needs results in less need to enrich the biofiltration soil mix. If nutrient quantity is then tailored to plants with lower nutrient needs, these plants will generally have less competition from weeds, which typically need higher nutrient content. The following practices are recommended to minimize nutrient needs of the plant palette:

- **Utilize native, drought-tolerant plants and grasses where possible.** Native plants generally have a broader tolerance for nutrient content, and can be longer lived in leaner/lower nutrient soils.
- **Start plants from smaller starts or seed.** Younger plants are generally more tolerant of lower nutrient levels and tend to help develop soil structure as they grow. Given the lower cost of smaller plants, the project should be able to accept a plant mortality rate that is somewhat higher than starting from larger plants and providing high organic content.

### 2. Minimize excess nutrients in media mix

Once the low-nutrient plant palette is established (item 1), the landscape architect and/or agronomist

should be consulted to assist in the design of a biofiltration media to balance the interests of plant establishment, water retention capacity (irrigation demand), and the potential for nutrient export. The following guidelines should be followed:

- **The mix should not exceed the nutrient needs of plants.** In conventional landscape design, the nutrient needs of plants are often exceeded intentionally in order to provide a factor of safety for plant survival. This practice must be avoided in biofiltration media as excess nutrients will increase the chance of export. The mix designer should keep in mind that nutrients can be added later (through mulching, tilling of amendments into the surface), but it is not possible to remove nutrients, once added.
- **The actual nutrient content and organic content of the selected organic amendment source should be determined when specifying mix proportions.** Nutrient content (i.e., C:N ratio; plant extractable nutrients) and organic content (i.e, % organic material) are relatively inexpensive to measure via standard agronomic methods and can provide important information about mix design. If mix design relies on approximate assumption about nutrient/organic content and this is not confirmed with testing (or the results of prior representative testing), it is possible that the mix could contain much more nutrient than intended.
- **Nutrients are better retained in soils with higher cation exchange capacity.** Cation exchange capacity can be increased through selection of organic material with naturally high cation exchange capacity, such as peat or coconut coir pith, and/or selection of inorganic material with high cation exchange capacity such as some sands or engineered minerals (e.g., low P-index sands, zeolites, rhyolites, etc). Including higher cation exchange capacity materials would tend to reduce the net export of nutrients. Natural silty materials also provide cation exchange capacity; however potential impacts to permeability need to be considered.
- **Focus on soil structure as well as nutrient content.** Soil structure is loosely defined as the ability of the soil to conduct and store water and nutrients as well as the degree of aeration of the soil. Soil structure can be more important than nutrient content in plant survival and biologic health of the system. If a good soil structure can be created with very low amounts of organic amendment, plants survivability should still be provided. While soil structure generally develops with time, biofiltration media can be designed to promote earlier development of soil structure. Soil structure is enhanced by the use of amendments with high humus content (as found in well-aged organic material). In addition, soil structure can be enhanced through the use of organic material with a distribution of particle sizes (i.e., a more heterogeneous mix).
- **Consider alternatives to compost.** Compost, by nature, is a material that is continually evolving and decaying. It can be challenging to determine whether tests previously done on a given compost stock are still representative. It can also be challenging to determine how the properties of the compost will change once placed in the media bed. More stable materials such as aged coco coir pith, peat, biochar, shredded bark, and/or other amendments should be considered.

With these considerations, it is anticipated that less than 10 percent organic amendment by volume could be used, while still balancing plant survivability and water retention. If compost is used, designers should strongly consider utilizing less than 10 percent by volume.

### 3. Design with partial retention and/or internal water storage

An internal water storage zone, as described in Fact Sheet PR-1 is believed to improve retention of nutrients. For lined systems, an internal water storage zone worked by providing a zone that fluctuates between aerobic and anaerobic conditions, resulting in nitrification/denitrification. In soils that will allow infiltration, a partial retention design (PR-1) allows significant volume reduction and can also promote nitrification/denitrification.

Acknowledgment: This fact sheet has been adapted from the Orange County Technical Guidance Document (May 2011). It was originally developed based on input from: Deborah Deets, City of Los Angeles Bureau of Sanitation, Drew Ready, Center for Watershed Health, Rick Fisher, ASLA, City of Los Angeles Bureau of Engineering, Dr. Garn Wallace, Wallace Laboratories, Glen Dake, GDML, and Jason Schmidt, Tree People. The guidance provided herein does not reflect the individual opinions of any individual listed above and should not be cited or otherwise attributed to those listed.

#### ***Maintenance Overview***

Refer to maintenance information provided in the Biofiltration (BF-1) Fact Sheet. Adjust maintenance actions and reporting if required based on the specific media design.

## E.20 BF-3 Proprietary Biofiltration Systems

The purpose of this fact sheet is to help explain the potential role of proprietary BMPs in meeting biofiltration requirements, when full retention of the DCV is not feasible. The fact sheet does not describe design criteria like the other fact sheets in this appendix because this information varies by BMP product model.

### **Criteria for Use of a Proprietary BMP as a Biofiltration BMP**

A proprietary BMP may be acceptable as a “biofiltration BMP” under the following conditions:

- (1) The BMP meets the minimum design criteria listed in Appendix F, including the pollutant treatment performance standard in Appendix F.1;
- (2) The BMP is designed and maintained in a manner consistent with its performance certifications (See explanation in Appendix F.2); and
- (3) The BMP is acceptable at the discretion of the City Engineer. In determining the acceptability of a BMP, the City Engineer should consider, as applicable, (a) the data submitted; (b) representativeness of the data submitted; (c) consistency of the BMP performance claims with pollutant control objectives; certainty of the BMP performance claims; (d) for projects within the public right of way and/or public projects: maintenance requirements, cost of maintenance activities, relevant previous local experience with operation and maintenance of the BMP type, ability to continue to operate the system in event that the vending company is no longer operating as a business; and (e) other relevant factors. If a proposed BMP is not accepted by the City Engineer, a written explanation/reason will be provided to the applicant.

### **Guidance for Sizing a Proprietary BMP as a Biofiltration BMP**

Proprietary biofiltration BMPs must meet the same sizing guidance as non-proprietary BMPs. Sizing is typically based on capturing and treating 1.50 times the DCV not reliably retained. Guidance for sizing biofiltration BMPs to comply with requirements of this manual is provided in Appendix F.2.

### **Maintenance Overview**

Refer to manufacturer for maintenance information.

## E.21 FT-1 Vegetated Swales

**MS4 Permit Category**

Flow-thru Treatment Control

**Manual Category**

Flow-thru Treatment Control

**Applicable Performance Standard**

Pollutant Control

**Primary Benefits**

Treatment

Volume Reduction (Incidental)

Peak Flow Attenuation

*Location: Eastlake Business Center, Chula Vista, California; Photo Credit: Eric Mosolgo*

**Description**

Vegetated swales are shallow, open channels that are designed to remove storm water pollutants by physically straining/filtering runoff through vegetation in the channel. Swales can be used in place of traditional curbs and gutters and are well-suited for use in linear transportation corridors to provide both conveyance and treatment via filtration. An effectively designed vegetated swale achieves uniform sheet flow through densely vegetated areas. When soil conditions allow, infiltration and volume reduction are enhanced by adding a gravel drainage layer underneath the swale. Vegetated swales with a subsurface media layer can provide enhanced infiltration, water retention, and pollutant-removal capabilities. Pollutant removal effectiveness can also be maximized by increasing the hydraulic residence time of water in swale using weirs or check dams.

Typical vegetated swale components include:

- Inflow distribution mechanisms (e.g., flow spreader)
- Surface flow
- Vegetated surface layer
- Check dams (if required)
- Optional aggregate storage layer with underdrain(s)



E.21: FT-1 Vegetated Swales

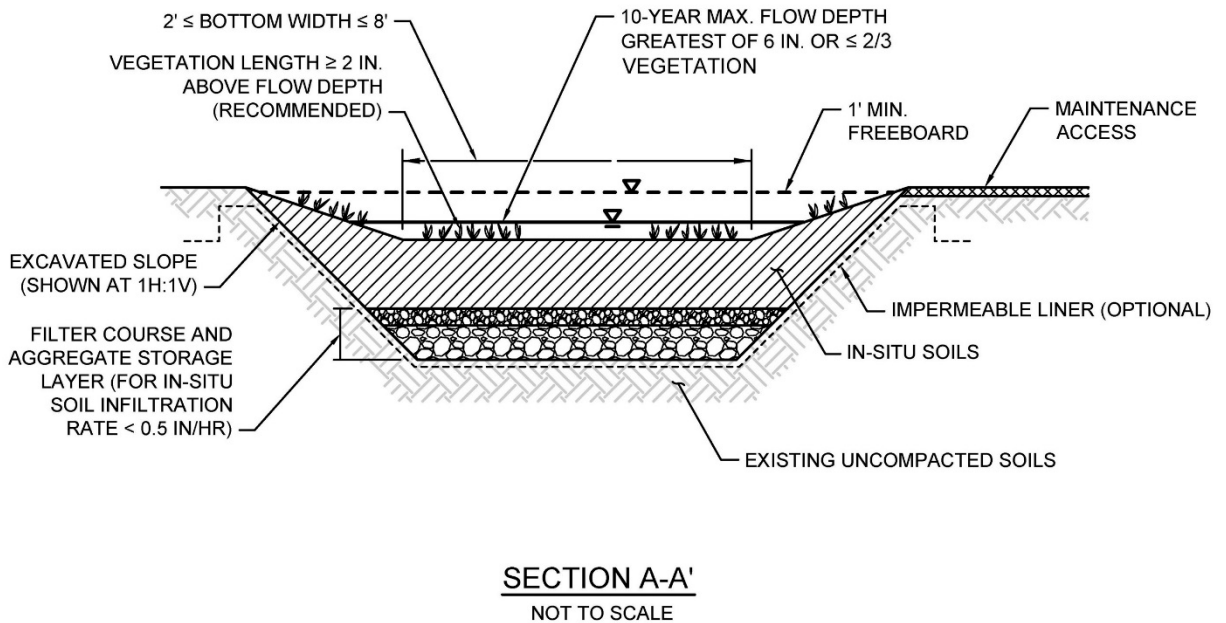
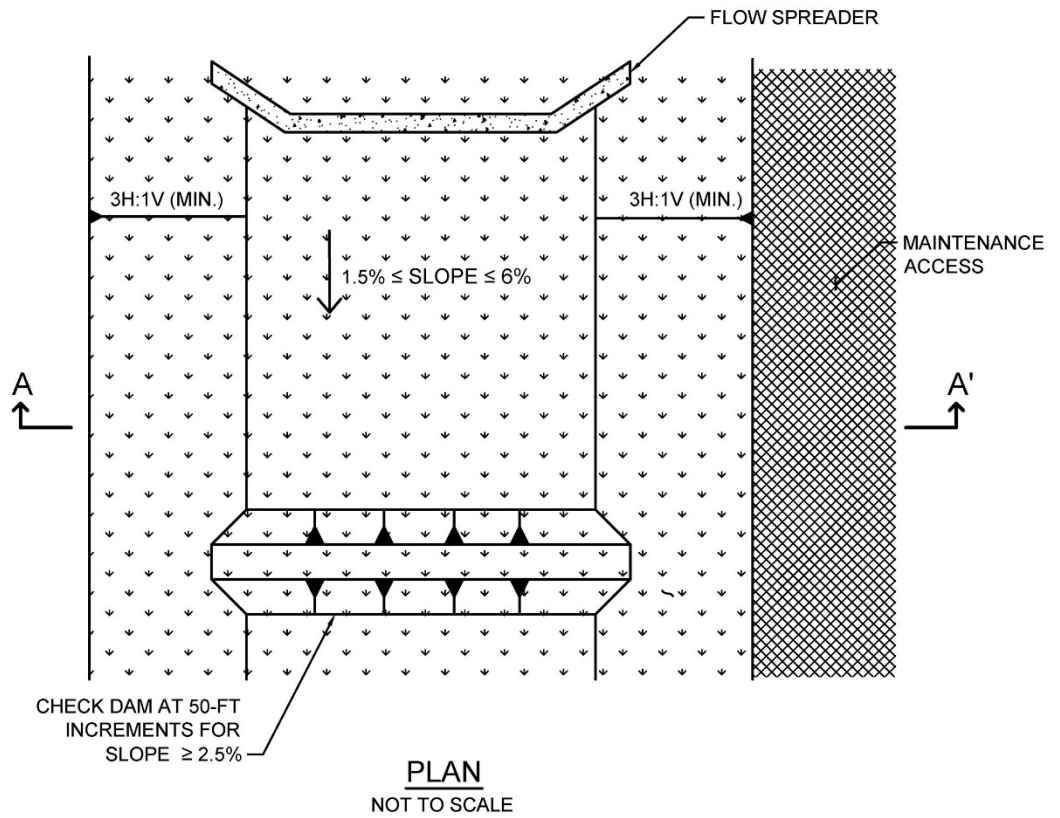

Typical plan and Section view of a Vegetated Swale BMP

**Design Adaptations for Project Goals**

**Site design BMP to reduce runoff volumes and storm peaks.** Swales without underdrains are an alternative to lined channels and pipes and can provide volume reduction through infiltration. Swales can also reduce the peak runoff discharge rate by increasing the time of concentration of the site and decreasing runoff volumes and velocities.

**Flow-thru treatment BMP for storm water pollutant control.** The system is lined or un-lined to provide incidental infiltration with an underdrain and designed to provide pollutant removal through settling and filtration in the channel vegetation (usually grasses). This configuration is considered to provide flow-thru treatment via horizontal surface flow through the swale. Sizing for flow-thru treatment control is based on the surface flow rate through the swale that meets water quality treatment performance objectives.

**Design Criteria and Considerations**

Vegetated swales must meet the following design criteria. Deviations from the below criteria may be approved at the discretion of the City Engineer if it is determined to be appropriate:

<i>Siting and Design</i>	<i>Intent/Rationale</i>
<input type="checkbox"/> Placement observes geotechnical recommendations regarding potential hazards (e.g., slope stability, landslides, and liquefaction zones) and setbacks (e.g., slopes, foundations, utilities).	Must not negatively impact existing site geotechnical concerns.
<input type="checkbox"/> An impermeable liner or other hydraulic restriction layer is included if site constraints indicate that infiltration or lateral flows should not be allowed.	Lining prevents storm water from impacting groundwater and/or sensitive environmental or geotechnical features. Incidental infiltration, when allowable, can aid in pollutant removal and groundwater recharge.
<input type="checkbox"/> Contributing tributary area $\leq 2$ acres.	Higher ratios increase the potential for clogging but may be acceptable for relatively clean tributary areas.
<input type="checkbox"/> Longitudinal slope is $\geq 1.5\%$ and $\leq 6\%$ .	Flatter swales facilitate increased water quality treatment while minimum slopes prevent ponding.

<i>Siting and Design</i>		<i>Intent/Rationale</i>
<input type="checkbox"/>	For site design goal, in-situ soil infiltration rate $\geq 0.5$ in/hr (if $< 0.5$ in/hr, an underdrain is required and design goal is for pollutant control only).	Well-drained soils provide volume reduction and treatment. An underdrain should only be provided when soil infiltration rates are low or per geotechnical or groundwater concerns.
<i>Surface Flow</i>		
<input type="checkbox"/>	Maximum flow depth is $\leq 6$ inches or $\leq \frac{2}{3}$ the vegetation length, whichever is greater. Ideally, flow depth will be $\geq 2$ inches below shortest plant species.	Flow depth must fall within the height range of the vegetation for effective water quality treatment via filtering.
	A minimum of 1 foot of freeboard is provided.	Freeboard minimizes risk of uncontrolled surface discharge.
<input type="checkbox"/>	Cross sectional shape is trapezoidal or parabolic with side slopes $\geq 3H:1V$ .	Gentler side slopes are safer, less prone to erosion, able to establish vegetation more quickly and easier to maintain.
<input type="checkbox"/>	Bottom width is $\geq 2$ feet and $\leq 8$ feet.	A minimum of 2 feet minimizes erosion. A maximum of 8 feet prevents channel braiding.
<input type="checkbox"/>	Minimum hydraulic residence time $\geq 10$ minutes.	Longer hydraulic residence time increases pollutant removal.
<input type="checkbox"/>	Swale is designed to safely convey the 10-yr storm event unless a flow splitter is included to allow only the water quality event.	Planning for larger storm events lessens the risk of property damage due to flooding.
<input type="checkbox"/>	Flow velocity is $\leq 1$ ft/s for water quality event. Flow velocity for 10-yr storm event is $\leq 3$ ft/s.	Lower flow velocities provide increased pollutant removal via filtration and minimize erosion.
<i>Vegetated Surface Layer (amendment with media is Optional)</i>		
<input type="checkbox"/>	Soil is amended with 2 inches of media mixed into the top 6 inches of in-situ soils, as needed, to promote plant growth (optional). For enhanced pollutant control, 2 feet of media can be used in place of in-situ soils. Media meets either of these two media specifications:	Amended soils aid in plant establishment and growth. Media replacement for in-situ soils can improve water quality treatment and site design volume reduction.

<i>Siting and Design</i>	<i>Intent/Rationale</i>
<p>City of San Diego Low Impact City of San Diego Storm Water Standards Appendix F, February 2016);</p> <p>Or County of San Diego Low Impact Development Handbook, June 2014: Appendix G -Bioretention Soil Specification.</p>	
<p><input type="checkbox"/> Vegetation is appropriately selected low-growing, erosion-resistant plant species that effectively bind the soil, thrive under site-specific climatic conditions and require little or no irrigation.</p>	<p>Plants suited to the climate and expected flow conditions are more likely to survive.</p>
<b><i>Check Dams</i></b>	
<p><input type="checkbox"/> Check dams are provided at 50-foot increments for slopes <math>\geq 2.5\%</math>.</p>	<p>Check dams prevent erosion and increase the hydraulic residence time by lowering flow velocities and providing ponding opportunities.</p>
<b><i>Filter Course Layer (For Underdrain Design)</i></b>	
<p><input type="checkbox"/> A filter course is used to prevent migration of fines through layers of the facility. Filter fabric is not used.</p>	<p>Migration of media can cause clogging of the aggregate storage layer void spaces or subgrade. Filter fabric is more likely to clog.</p>
<p><input type="checkbox"/> Filter course is washed and free of fines.</p>	<p>Washing aggregate will help eliminate fines that could clog the facility and impede infiltration.</p>
<p><input type="checkbox"/> Filter course calculations assessing suitability for particle migration prevention have been completed.</p>	<p>Gradation relationship between layers can evaluate factors (e.g., bridging, permeability, and uniformity) to determine if particle sizing is appropriate or if an intermediate layer is needed.</p>
<b><i>Aggregate Storage Layer (For Underdrain Design)</i></b>	
<p><input type="checkbox"/> The depth of aggregate provided (12-inch typical) and storage layer configuration is adequate for providing conveyance for underdrain flows to the outlet structure.</p>	<p>Proper storage layer configuration and underdrain placement will minimize facility drawdown time.</p>

<i>Siting and Design</i>	<i>Intent/Rationale</i>
<input type="checkbox"/> Aggregate used for the aggregate storage layer is washed and free of fines.	Washing aggregate will help eliminate fines that could clog aggregate storage layer void spaces or underdrain.
<b><i>Inflow and Underdrain Structures</i></b>	
<input type="checkbox"/> Inflow and underdrains are accessible for inspection and maintenance.	Maintenance will prevent clogging and ensure proper operation of the flow control structures.
<input type="checkbox"/> Underdrain outlet elevation should be a minimum of 3 inches above the bottom elevation of the aggregate storage layer.	A minimal separation from subgrade or the liner lessens the risk of fines entering the underdrain and can improve hydraulic performance by allowing perforations to remain unblocked.
<input type="checkbox"/> Minimum underdrain diameter is 6 inches.	Smaller diameter underdrains are prone to clogging.
<input type="checkbox"/> Underdrains are made of slotted, PVC pipe conforming to ASTM D 3034 or equivalent or corrugated, HDPE pipe conforming to AASHTO 252M or equivalent.	Slotted underdrains provide greater intake capacity, clog resistant drainage, and reduced entrance velocity into the pipe, thereby reducing the chances of solids migration.
<input type="checkbox"/> An underdrain cleanout with a minimum 6-inch diameter and lockable cap is placed every 250 to 300 feet as required based on underdrain length.	Properly spaced cleanouts will facilitate underdrain maintenance.

**Conceptual Design and Sizing Approach for Site Design**

1. Determine the areas where vegetated swales can be used in the site design to replace traditional curb and gutter facilities and provide volume reduction through infiltration.

**Conceptual Design and Sizing Approach for Storm Water Pollutant Control Only**

To design vegetated swales for storm water pollutant control only, the following steps should be taken:

1. Verify that siting and design criteria have been met, including bottom width and longitudinal and side slope requirements.
2. Calculate the design flow rate per Appendix B based on expected site design runoff for tributary areas.

3. Use the sizing worksheet to determine flow-thru treatment sizing of the vegetated swale and if flow velocity, flow depth, and hydraulic residence time meet required criteria. Swale configuration should be adjusted as necessary to meet design requirements.

### **Maintenance Overview**

**Normal Expected Maintenance.** Vegetated swales require routine maintenance to: remove accumulated materials such as sediment, trash, and debris; maintain vegetation health; and maintain integrity of side slopes, channel bottom, inlets, energy dissipaters, weirs or check dams, and outlets to ensure runoff will be conveyed as uniform flow throughout the swale (i.e., flow will spread uniformly across the width of the swale as it is conveyed from upstream to downstream).

**Non-Standard Maintenance or BMP Failure.** If any of the following scenarios are observed, the BMP is not performing as intended to protect downstream waterways from pollution and/or erosion. Corrective maintenance, increased inspection and maintenance, BMP replacement, or a different BMP type will be required.

- The BMP is not drained between storm events. Surface ponding longer than approximately 24 hours following a storm event may be detrimental to vegetation health, and surface ponding longer than approximately 96 hours following a storm event poses a risk of vector (mosquito) breeding. Poor drainage can result from deposited materials or overgrowth of vegetation within the swale blocking drainage conveyance or blocking an outlet structure, or localized erosion issues that cause channelization and prevent uniform flow throughout the swale. The specific cause of the drainage issue must be determined and corrected. If the issue is not corrected by restoring the BMP to the original plan and grade, the City Engineer shall be contacted prior to any additional repairs or reconstruction.
- Sediment, trash, or debris accumulation blocking drainage becomes a chronic issue observed at every inspection. This means the load from the tributary drainage area is too high, reducing BMP function or clogging the BMP. This would require pretreatment measures within the tributary area draining to the BMP to intercept the materials.
- Erosion due to concentrated storm water runoff flow that is not readily corrected by adding erosion control blankets, adding stone at flow entry points, or minor re-grading to restore proper drainage according to the original plan. If the issue is not corrected by restoring the BMP to the original plan and grade, the City Engineer shall be contacted prior to any additional repairs or reconstruction.

**Sediment Loading.** Consider the effects of BMP design and tributary area land uses on the clogging potential of the BMP. Complete the sediment loading analysis included in Appendix E.27.

**Summary of Standard Inspection and Maintenance**

The property owner is responsible to ensure inspection, operation and maintenance of permanent BMPs on their property unless responsibility has been formally transferred to an agency, community facilities district, homeowners association, property owners association, or other special district.

Maintenance frequencies listed in this table are average/typical frequencies. Actual maintenance needs are site-specific, and maintenance may be required more frequently. Maintenance must be performed whenever needed, based on maintenance indicators presented in this table. The BMP owner is responsible for conducting regular inspections to see when maintenance is needed based on the maintenance indicators. During the first year of operation of a structural BMP, inspection is recommended at least once prior to August 31 and then monthly from September through May. Inspection during a storm event is also recommended. After the initial period of frequent inspections, the minimum inspection and maintenance frequency can be determined based on the results of the first year inspections.

Threshold/Indicator	Maintenance Action	Typical Maintenance Frequency
Accumulation of sediment, litter, or debris	Remove and properly dispose of accumulated materials, without damage to vegetation.	<ul style="list-style-type: none"> <li>• Inspect monthly. If accumulated materials are observed blocking drainage, increase inspection frequency to monthly plus after every 0.1-inch or larger storm event.</li> <li>• Remove any accumulated materials found at each inspection.</li> </ul>
Obstructed inlet or outlet structure	Clear blockage.	<ul style="list-style-type: none"> <li>• Inspect monthly and after every 0.5-inch or larger storm event.</li> <li>• Remove any accumulated materials found at each inspection.</li> </ul>
Damage to structural components such as weirs, inlet or outlet structures	Repair or replace as applicable.	<ul style="list-style-type: none"> <li>• Inspect annually.</li> <li>• Maintain when needed.</li> </ul>

Threshold/Indicator	Maintenance Action	Typical Maintenance Frequency
Poor vegetation establishment	Re-seed, re-plant, or re-establish vegetation per original plans.	<ul style="list-style-type: none"> <li>• Inspect monthly.</li> <li>• Maintain when needed.</li> </ul>
Dead or diseased vegetation	Remove dead or diseased vegetation, re-seed, re-plant, or re-establish vegetation per original plans.	<ul style="list-style-type: none"> <li>• Inspect monthly.</li> <li>• Maintain when needed.</li> </ul>
Overgrown vegetation	Mow or trim as appropriate.	<ul style="list-style-type: none"> <li>• Inspect monthly.</li> <li>• Maintain when needed.</li> </ul>
Erosion due to concentrated irrigation flow	Repair/re-seed/re-plant eroded areas and adjust the irrigation system.	<ul style="list-style-type: none"> <li>• Inspect monthly.</li> <li>• Maintain when needed.</li> </ul>
Erosion due to concentrated storm water runoff flow	Repair/re-seed/re-plant eroded areas, and make appropriate corrective measures such as adding erosion control blankets, adding stone at flow entry points, or minor re-grading to restore proper drainage according to the original plan. If the issue is not corrected by restoring the BMP to the original plan and grade, the City Engineer shall be contacted prior to any additional repairs or reconstruction.	<ul style="list-style-type: none"> <li>• Inspect after every 0.5-inch or larger storm event. If erosion due to storm water flow has been observed, increase inspection frequency to after every 0.1-inch or larger storm event.</li> <li>• Maintain when needed. If the issue is not corrected by restoring the BMP to the original plan and grade, the City Engineer shall be contacted prior to any additional repairs or reconstruction.</li> </ul>



Threshold/Indicator	Maintenance Action	Typical Maintenance Frequency
<p>Standing water in BMP following a storm event</p>	<p>Make appropriate corrective measures such as adjusting irrigation system, removing obstructions of debris or invasive vegetation, loosening or replacing top soil to allow for better infiltration, or minor re-grading for proper drainage. If the issue is not corrected by restoring the BMP to the original plan and grade, the City Engineer shall be contacted prior to any additional repairs or reconstruction.</p>	<ul style="list-style-type: none"> <li>• Inspect monthly and after every 0.5-inch or larger storm event. If standing water is observed, increase inspection frequency to after every 0.1-inch or larger storm event.</li> <li>• Maintain when needed.</li> </ul>
<p>Presence of mosquitos/larvae</p> <p>For images of egg rafts, larva, pupa, and adult mosquitos, see <a href="http://www.mosquito.org/biology">http://www.mosquito.org/biology</a></p>	<p>If mosquitos/larvae are observed: first, immediately remove any standing water by dispersing to nearby landscaping; second, make corrective measures as applicable to restore BMP drainage to prevent standing water.</p> <p>If mosquitos persist following corrective measures to remove standing water, the City Engineer shall be contacted to determine a solution. A different BMP type, or a Vector Management Plan prepared with concurrence from the County of San Diego Department of Environmental Health, may be required.</p>	<ul style="list-style-type: none"> <li>• Inspect monthly and after every 0.5-inch or larger storm event. If mosquitos are observed, increase inspection frequency to after every 0.1-inch or larger storm event.</li> <li>• Maintain when needed.</li> </ul>

## E.22 FT-2 Media Filters

**MS4 Permit Category**

Flow-thru Treatment Control

**Manual Category**

Flow-thru Treatment Control

**Applicable Performance Standard**

Pollutant Control

Flow Control

**Primary Benefits**

Treatment

Peak Flow Attenuation (Optional)

*Photo Credit: Contech Stormwater Solutions***Description**

Media filters are manufactured devices that consist of a series of modular filters packed with engineered media that can be contained in a catch basin, manhole, or vault that provide treatment through filtration and sedimentation. The manhole or vault may be divided into multiple chambers where the first chamber acts as a presettling basin for removal of coarse sediment while the next chamber acts as the filter bay and houses the filter cartridges. A variety of media types are available from various manufacturers that can target pollutants of concern via primarily filtration, sorption, ion exchange, and precipitation. **Specific products must be selected to meet the flow-thru BMP selection requirements described in Appendix B.6.** Treatment effectiveness is contingent upon proper maintenance of filter units.

Typical media filter components include:

- Vault for flow storage and media housing
- Inlet and outlet
- Media filters

**Design Adaptations for Project Goals**

**Flow-thru treatment BMP for storm water pollutant control.** Water quality treatment is provided through filtration. This configuration is considered to provide flow-thru treatment, not biofiltration treatment. Storage provided within the vault restricted by an outlet is considered detention storage and is included in calculations for the flow-thru treatment volume.

**Integrated storm water flow control and pollutant control configuration.** Media filters can also be designed for flow rate and duration control via additional detention storage. The vault storage can be designed to accommodate higher volumes than the storm water pollutant control volume and can utilize multi-stage outlets to mitigate both the duration and rate of flows within a prescribed range.

**Design Criteria and Considerations**

Media filters must meet the following design criteria. Deviations from the below criteria may be approved at the discretion of the City Engineer if it is determined to be appropriate:

<i>Siting and Design</i>	<i>Intent/Rationale</i>
<input type="checkbox"/> Placement observes geotechnical recommendations regarding potential hazards (e.g., slope stability, landslides, and liquefaction zones) and setbacks (e.g., slopes, foundations, utilities).	Must not negatively impact existing site geotechnical concerns.
<input type="checkbox"/> Recommended for tributary areas with limited available surface area or where surface BMPs would restrict uses.	Maintenance needs may be more labor intensive for media filters than surface BMPs. Lack of surface visibility creates additional risk that maintenance needs may not be completed in a timely manner.
<input type="checkbox"/> Vault storage drawdown time $\leq 96$ hours.	Provides vector control.
<input type="checkbox"/> Vault storage drawdown time $\leq 36$ hours if the vault is used for equalization of flows for pollutant treatment.	Provides required capacity to treat back to back storms. Exception to the 36 hour drawdown criteria is allowed if additional vault storage is provided using the curves in Appendix B.4.2.
<i>Inflow and Outflow Structures</i>	
<input type="checkbox"/> Inflow and outflow structures are accessible by required equipment (e.g., vector truck) for inspection and maintenance.	Maintenance will prevent clogging and ensure proper operation of the flow control structures.

### ***Conceptual Design and Sizing Approach for Storm Water Pollutant Control Only***

To design a media filter for storm water pollutant control only (no flow control required), the following steps should be taken

1. Verify that the selected BMP complies with BMP selection requirements in Appendix B.6.
2. Verify that placement and tributary area requirements have been met.
3. Calculate the required DCV and/or flow rate per Appendix B.6.3 based on expected site design runoff for tributary areas.
4. Media filter can be designed either for DCV or flow rate. To estimate the drawdown time, divide the vault storage by the treatment rate of media filters.

### ***Conceptual Design and Sizing Approach when Storm Water Flow Control is Applicable***

Control of flow rates and/or durations will typically require significant vault storage volume, and therefore the following steps should be taken prior to determination of storm water pollutant control design. Pre-development and allowable post-project flow rates and durations should be determined as discussed in Chapter 6 of the manual.

1. Verify that placement and tributary area requirements have been met.
2. Iteratively determine the vault storage volume required to provide detention storage to reduce flow rates and durations to allowable limits. Flow rates and durations can be controlled from detention storage by altering outlet structure orifice size(s) and/or water control levels. Multi-level orifices can be used within an outlet structure to control the full range of flows to MS4.
3. If a media filter cannot fully provide the flow rate and duration control required by this manual, an upstream or downstream structure with appropriate storage volume such as an underground vault can be used to provide remaining controls.
4. After the media filter has been designed to meet flow control requirements, calculations must be completed to verify if storm water pollutant control requirements to treat the DCV have been met.
5. Verify that the vault drawdown time is 96 hours or less. To estimate the drawdown time:
  - a. Divide the vault volume by the filter surface area.
  - b. Divide the result (a) by the design filter rate.

### **Maintenance Overview**

**Normal Expected Maintenance.** Media filters require routine maintenance to: remove accumulated materials such as sediment, trash, and debris; replace filter cartridges; and maintain integrity of any internal components such as weirs and piping. A summary table of standard inspection and maintenance indicators is provided within this Fact Sheet.

**Non-Standard Maintenance or BMP Failure.** The normal expected maintenance described above ensures the BMP functionality. Lapses in the normal expected maintenance can lead to clogging of the BMP and potentially blocking the storm drain system. If clogging is observed, the BMP is not performing as intended to protect downstream waterways from pollution and/or erosion. In addition, clogged BMPs can lead to flooding, standing water and mosquito breeding habitat. Maintenance is critical to ensure the flood protection capacity of the storm drain system is not compromised. If proper routine maintenance is not performed, corrective maintenance and increased inspection and maintenance will be required. For persistent clogging or presence of mosquitos, contact the City Engineer to determine a permanent solution. For example, adding pretreatment measures within the tributary area draining to the BMP to intercept sediment, trash, and debris. Pretreatment components, especially for sediment, will extend the life of the filter media. For mosquitos, a Vector Management Plan, prepared with concurrence from the County of San Diego Department of Environmental Health, may be required.

**Other Special Considerations.** Media filters are proprietary systems that include proprietary media that must be replaced as part of normal expected maintenance. They are typically installed underground and may require entry into the underground vault to perform the maintenance. The BMP owner is responsible to hire a maintenance operator qualified to service the units. The maintenance operator must obtain the appropriate filter media and/or any parts that need to be replaced. If maintenance conditions require maintenance personnel to enter the underground structure, the maintenance personnel must be trained and certified in confined space entry. To find a qualified maintenance operator, the BMP owner shall contact the manufacturer of the proprietary BMP.

The design of media filters includes consideration of the specific pollutants expected from the area tributary to the media filter and the specific pollutants of concern for the downstream waterways. Therefore, it is expected that the filter media selected during design of the project will not be substituted. If a need arises to substitute a different filter configuration or filter media, the City Engineer shall be contacted prior to any changes.

**Sediment Loading.** Consider the effects of BMP design and tributary area land uses on the clogging potential of the BMP. Complete the sediment loading analysis included in Appendix E.27.

**Summary of Standard Inspection and Maintenance**

The property owner is responsible to ensure inspection, operation and maintenance of permanent BMPs on their property unless responsibility has been formally transferred to an agency, community facilities district, homeowners association, property owners association, or other special district.

Maintenance frequencies listed in this table are average/typical frequencies. Actual maintenance needs are site-specific, and maintenance may be required more frequently. Maintenance must be performed whenever needed, based on maintenance indicators presented in this table. The BMP owner is responsible for conducting regular inspections to see when maintenance is needed based on the maintenance indicators. During the first year of operation of a structural BMP, inspection is recommended at least once prior to August 31 and then monthly from September through May. Inspection during a storm event is also recommended. After the initial period of frequent inspections, the minimum inspection and maintenance frequency can be determined based on the results of the first year inspections.

Threshold/Indicator	Maintenance Action	Typical Maintenance Frequency
<p>Accumulation of sediment, litter, or debris.</p> <p>The threshold for removal of materials depends on the specific type of proprietary filter and configuration and shall be based on the manufacturer’s recommendation. In any case, materials must be removed if accumulation blocks flow through the BMP.</p>	<p>Remove and properly dispose of accumulated materials.</p>	<ul style="list-style-type: none"> <li>• Inspect monthly.</li> <li>• Remove materials annually (minimum), or more frequently when BMP reaches manufacturer’s threshold for removal of materials in less than one year, or if accumulation blocks outlet.</li> </ul>

Threshold/Indicator	Maintenance Action	Typical Maintenance Frequency
<p>Spent or clogged filter media.</p> <p>The threshold for changing media depends on the specific type of proprietary media and shall be based on the manufacturer’s recommendation. In any case, media must be replaced if flow cannot pass through the media or passes through at less than the design capacity.</p>	<p>Remove and properly dispose filter media, and replace with fresh media.</p>	<ul style="list-style-type: none"> <li>• Inspect condition of media annually or more frequently if recommended by manufacturer.</li> <li>• Inspect BMP drainage monthly and after every 0.5-inch or larger storm event. If standing water has been observed, increase inspection frequency to after every 0.1-inch or larger storm event.</li> <li>• Maintain when needed based on manufacturer’s threshold/indicator for the specific media, or if standing water in the BMP indicates flow cannot pass through the media.</li> </ul>
<p>Any other recommendations pursuant to the proprietary filter manufacturer’s maintenance guide.</p>	<p>Any other actions pursuant to the proprietary filter manufacturer’s maintenance guide.</p>	<ul style="list-style-type: none"> <li>• As recommended by the proprietary filter manufacturer’s maintenance guide</li> </ul>
<p>Obstructed inlet or outlet structure</p>	<p>Clear blockage.</p>	<ul style="list-style-type: none"> <li>• Inspect monthly and after every 0.5-inch or larger storm event.</li> <li>• Remove any accumulated materials found at each inspection.</li> </ul>

Threshold/Indicator	Maintenance Action	Typical Maintenance Frequency
<p>Presence of mosquitos/larvae</p> <p>For images of egg rafts, larva, pupa, and adult mosquitos, see <a href="http://www.mosquito.org/biology">http://www.mosquito.org/biology</a></p>	<p>If mosquitos/larvae are observed: first, immediately remove and properly dispose any standing water; second, remove any accumulated materials that obstruct flow through the BMP to restore BMP drainage to prevent standing water. Ensure access covers are tight fitting, with gaps or holes no greater than 1/16 inch, and/or install barriers such as inserts or screens that prevent mosquito access to the subsurface storage.</p> <p>If the BMP includes a permanent sump, contact the City Engineer to determine a permanent solution. A different BMP type, or a Vector Management Plan prepared with concurrence from the County of San Diego Department of Environmental Health, may be required.</p>	<ul style="list-style-type: none"> <li>• Inspect monthly and after every 0.5-inch or larger storm event. If mosquitos are observed, increase inspection frequency to after every 0.1-inch or larger storm event.</li> <li>• Maintain when needed.</li> </ul>
<p>Damage to structural components of the filtration system such as weirs, underdrains, inlet or outlet structures</p>	<p>Repair or replace as applicable.</p>	<ul style="list-style-type: none"> <li>• Inspect annually.</li> <li>• Maintain when needed.</li> </ul>



## E.23 FT-3 Sand Filters



*Photo Credit: City of San Diego LID Manual*

---

**MS4 Permit Category**

---

Flow-thru Treatment Control

---

**Manual Category**

---

Flow-thru Treatment Control

---

**Applicable Performance Standard**

---

Pollutant Control

Flow Control

---

**Primary Benefits**

---

Treatment

Volume Reduction (Incidental)

Peak Flow Attenuation (Optional)

---

**Description**

---

Sand filters operate by filtering storm water through a constructed sand bed with an underdrain system. Runoff enters the filter and spreads over the surface. Sand filter beds can be enclosed within concrete structures or within earthen containment. As flows increase, water backs up on the surface of the filter where it is held until it can percolate through the sand. The treatment pathway is downward (vertical) through the media to an underdrain system that is connected to the downstream storm drain system. As storm water passes through the sand, pollutants are trapped on the surface of the filter, in the small pore spaces between sand grains or are adsorbed to the sand surface. The high filtration rates of sand filters, which allow a large runoff volume to pass through the media in a short amount of time, can provide efficient treatment for storm water runoff.

Typical sand filter components include:

- Forebay for pretreatment/energy dissipation
- Surface ponding for captured flows
- Sand filter bed
- Aggregate storage layer with underdrain(s)
- Overflow structure

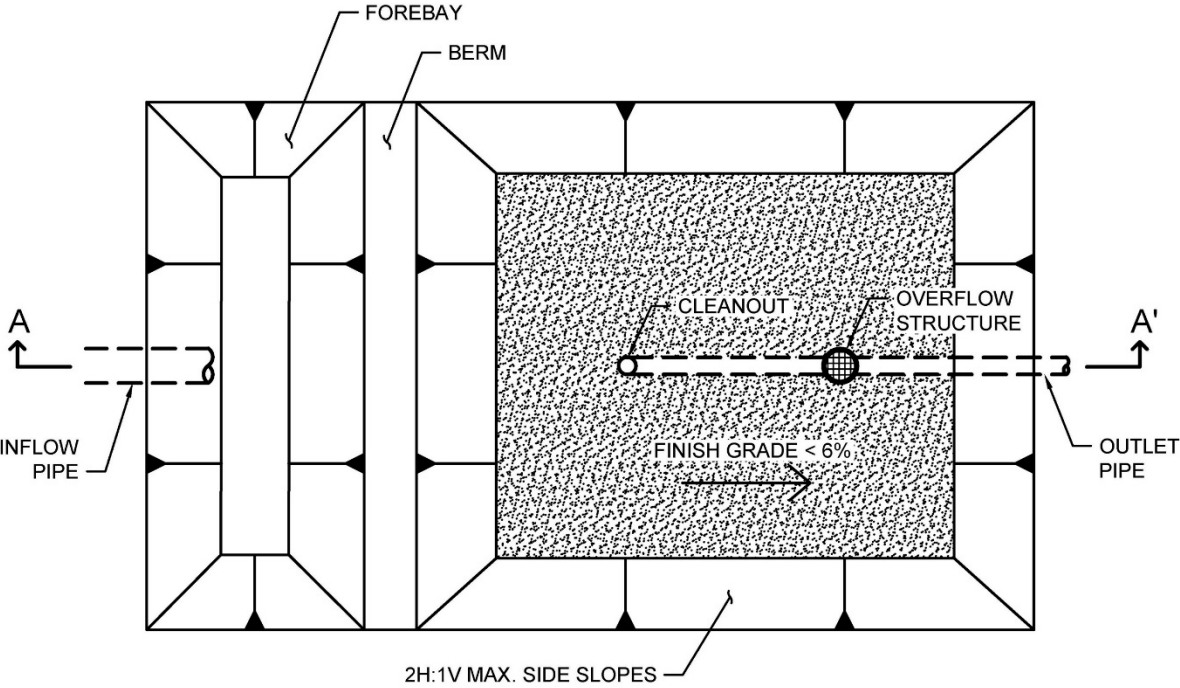

**PLAN**  
NOT TO SCALE

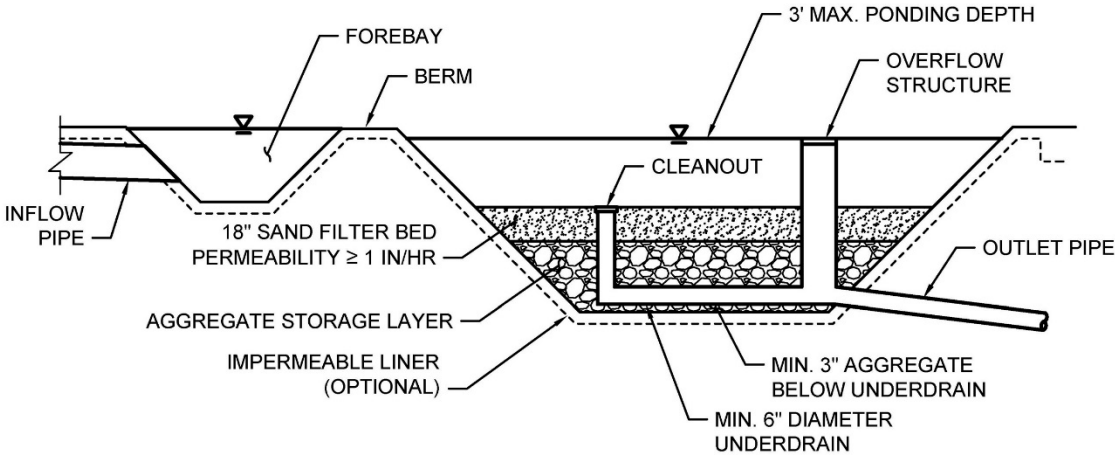

**SECTION A-A'**  
NOT TO SCALE

**Typical plan and Section view of a Sand Filter BMP**

**Design Adaptations for Project Goals**

**Flow-thru treatment BMP for storm water pollutant control.** The system is lined or un-lined to provide incidental infiltration, and an underdrain is provided at the bottom to carry away filtered runoff. This configuration is considered to provide flow-thru treatment via vertical flow through the sand filter bed. Storage provided above the underdrain within surface ponding, the sand filter bed, and aggregate storage is considered included in the flow-thru treatment volume. Saturated storage within the aggregate storage layer can be added to this design by including an upturned elbow installed at the downstream end of the underdrain or via an internal weir structure designed to maintain a specific water level elevation.

**Integrated storm water flow control and pollutant control configuration.** The system can be designed to provide flow rate and duration control by primarily providing increased surface ponding and/or having a deeper aggregate storage layer above the underdrain. This will allow for significant detention storage, which can be controlled via inclusion of an outlet structure at the downstream end of the underdrain.

**Design Criteria and Considerations**

Sand filters must meet the following design criteria. Deviations from the below criteria may be approved at the discretion of the City Engineer if it is determined to be appropriate:

<i>Siting and Design</i>	<i>Intent/Rationale</i>
<input type="checkbox"/> Placement observes geotechnical recommendations regarding potential hazards (e.g., slope stability, landslides, and liquefaction zones) and setbacks (e.g., slopes, foundations, utilities).	Must not negatively impact existing site geotechnical concerns.
<input type="checkbox"/> An impermeable liner or other hydraulic restriction layer is included if site constraints indicate that infiltration or lateral flows should not be allowed.	Lining prevents storm water from impacting groundwater and/or sensitive environmental or geotechnical features. Incidental infiltration, when allowable, can aid in pollutant removal and groundwater recharge.
<input type="checkbox"/> Contributing tributary area ( $\leq 5$ acres).	Bigger BMPs require additional design features for proper performance.  Contributing tributary area greater than 5 acres may be allowed at the discretion of the City Engineer if the following conditions are met: 1) incorporate design features (e.g. flow spreaders) to minimizing short circuiting of flows in the BMP and 2) incorporate

<i>Siting and Design</i>	<i>Intent/Rationale</i>
	additional design features requested by the City Engineer for proper performance of the regional BMP.
<input type="checkbox"/> Finish grade of facility is < 6%.	Flatter surfaces reduce erosion and channelization within the facility.
<input type="checkbox"/> Earthen side slopes are ≥ 3H:1V.	Gentler side slopes are safer, less prone to erosion, able to establish vegetation more quickly and easier to maintain.
<input type="checkbox"/> Surface ponding is limited to a 36-hour drawdown time.	Provides required capacity to treat back to back storms. Exception to the 36 hour drawdown criteria is allowed if additional surface storage is provided using the curves in Appendix B.4.2.
<input type="checkbox"/> Surface ponding is limited to a 96-hour drawdown time.	Prolonged surface ponding can create a vector hazard.
<input type="checkbox"/> Maximum ponding depth does not exceed 3 feet.	Surface ponding capacity lowers subsurface storage requirements and results in lower cost facilities. Deep surface ponding raises safety concerns.
<input type="checkbox"/> Sand filter bed consists of clean washed concrete or masonry sand (passing ¼ inch sieve) or sand similar to the ASTM C33 gradation.	Washing sand will help eliminate fines that could clog the void spaces of the aggregate storage layer.
<input type="checkbox"/> Sand filter bed permeability is at least 1 in/hr.	A high filtration rate through the media allows flows to quickly enter the aggregate storage layer, thereby minimizing bypass.
<input type="checkbox"/> Sand filter bed depth is at least 18 inches deep.	Different pollutants are removed in various zones of the media using several mechanisms. Some pollutants bound to sediment, such as metals, are typically removed within 18 inches of the media.
<input type="checkbox"/> Aggregate storage should be washed, bank-run gravel.	Washing aggregate will help eliminate fines that could clog the aggregate storage layer void spaces or subgrade.

<i>Siting and Design</i>	<i>Intent/Rationale</i>
<input type="checkbox"/> The depth of aggregate provided (12-inch typical) and storage layer configuration is adequate for providing conveyance for underdrain flows to the outlet structure.	Proper storage layer configuration and underdrain placement will minimize facility drawdown time.
<input type="checkbox"/> Inflow, underdrains and outflow structures are accessible for inspection and maintenance.	Maintenance will prevent clogging and ensure proper operation of the flow control structures.
<input type="checkbox"/> Inflow must be non-erosive sheet flow ( $\leq 3$ ft/s) unless an energy-dissipation device, flow diversion/splitter or forebay is installed.	Concentrated flow and/or excessive volumes can cause erosion in a sand filter and can be detrimental to the treatment capacity of the system.
<input type="checkbox"/> Underdrain outlet elevation should be a minimum of 3 inches above the bottom elevation of the aggregate storage layer.	A minimal separation from subgrade or the liner lessens the risk of fines entering the underdrain and can improve hydraulic performance by allowing perforations to remain unblocked.
<input type="checkbox"/> Minimum underdrain diameter is 6 inches.	Smaller diameter underdrains are prone to clogging.
<input type="checkbox"/> Underdrains should be made of slotted, PVC pipe conforming to ASTM D 3034 or equivalent or corrugated, HDPE pipe conforming to AASHTO 252M or equivalent.	Slotted underdrains provide greater intake capacity, clog resistant drainage, and reduced entrance velocity into the pipe, thereby reducing the chances of solids migration.
<input type="checkbox"/> Overflow is safely conveyed to a downstream storm drain system or discharge point.	Planning for overflow lessens the risk of property damage due to flooding.

### **Conceptual Design and Sizing Approach for Storm Water Pollutant Control Only**

To design a sand filter for storm water pollutant control only (no flow control required), the following steps should be taken:

1. Verify that siting and design criteria have been met, including placement requirements, contributing tributary area, and maximum finish grade slope.
2. Calculate the required DCV and/or flow rate per Appendix B.6.3 based on expected site design runoff for tributary areas.

3. Sand filter can be designed either for DCV or flow rate. To estimate the drawdown time, divide the average ponding depth by the permeability of the filter sand.

#### **Conceptual Design and Sizing Approach when Storm Water Flow Control is Applicable**

Control of flow rates and/or durations will typically require significant surface ponding and/or aggregate storage volumes, and therefore the following steps should be taken prior to determination of storm water pollutant control design. Pre-development and allowable post-project flow rates and durations should be determined as discussed in Chapter 6 of the Manual.

1. Verify that siting and design criteria have been met, including placement requirements, contributing tributary area, and maximum finish grade slope.
2. Iteratively determine the facility footprint area, surface ponding and/or aggregate storage layer depth required to provide detention storage to reduce flow rates and durations to allowable limits. Flow rates and durations can be controlled from detention storage by altering outlet structure orifice size(s) and/or water control levels. Multi-level orifices can be used within an outlet structure to control the full range of flows.
3. If a sand filter cannot fully provide the flow rate and duration control required by the MS4 permit, an upstream or downstream structure with appropriate storage volume such as an underground vault can be used to provide remaining controls.
4. After the sand filter has been designed to meet flow control requirements, calculations must be completed to verify if storm water pollutant control requirements to treat the DCV have been met.

#### **Maintenance Overview**

**Normal Expected Maintenance.** Sand filters require routine maintenance to: remove accumulated materials such as sediment, trash, and debris from the forebay; and clear the underdrain(s). To ensure runoff is passed through the sand bed, sand at the top of the sand bed (approximately 2 inches, or more if necessary) must be removed and replaced to restore flow when the drain time exceeds 24-96 hours. A summary table of standard inspection and maintenance indicators is provided within this Fact Sheet.

**Non-Standard Maintenance or BMP Failure.** The normal expected maintenance described above ensures the BMP functionality. Lapses in the normal expected maintenance can lead to clogging of the BMP and runoff bypassing the filter. If clogging is observed, the BMP is not performing as intended to protect downstream waterways from pollution and/or erosion. In addition, clogged BMPs can lead to flooding, standing water and mosquito breeding habitat. Corrective maintenance and increased inspection and maintenance will be required. For persistent clogging or presence of mosquitos, contact the City Engineer to determine a permanent solution. For example, adding pretreatment measures within the tributary area draining to the BMP to intercept sediment, trash, and debris. Pretreatment components, especially for sediment, will extend the life of the sand bed. For

mosquitos, a Vector Management Plan, prepared with concurrence from the County of San Diego Department of Environmental Health, may be required.

**Sediment Loading.** Consider the effects of BMP design and tributary area land uses on the clogging potential of the BMP. Complete the sediment loading analysis included in Appendix E.27.

**Summary of Standard Inspection and Maintenance**

The property owner is responsible to ensure inspection, operation and maintenance of permanent BMPs on their property unless responsibility has been formally transferred to an agency, community facilities district, homeowners association, property owners association, or other special district.

Maintenance frequencies listed in this table are average/typical frequencies. Actual maintenance needs are site-specific, and maintenance may be required more frequently. Maintenance must be performed whenever needed, based on maintenance indicators presented in this table. The BMP owner is responsible for conducting regular inspections to see when maintenance is needed based on the maintenance indicators. During the first year of operation of a structural BMP, inspection is recommended at least once prior to August 31 and then monthly from September through May. Inspection during a storm event is also recommended. After the initial period of frequent inspections, the minimum inspection and maintenance frequency can be determined based on the results of the first year inspections.

Threshold/Indicator	Maintenance Action	Typical Maintenance Frequency
Accumulation of sediment, litter, or debris in forebay and/or filter bed	Remove and properly dispose of accumulated materials.	<ul style="list-style-type: none"> <li>• Inspect monthly. If the forebay is 25% full* or more in one month, increase inspection frequency to monthly plus after every 0.1-inch or larger storm event.</li> <li>• Remove any accumulated materials found within the filter bed at each inspection.</li> <li>• When the BMP includes a forebay, materials must be removed from the forebay when the forebay is 25% full*, or if accumulation within the forebay blocks flow to the filter bed.</li> </ul>



Threshold/Indicator	Maintenance Action	Typical Maintenance Frequency
Standing water in BMP for longer than 24-96 hours following a storm event	Make appropriate corrective measures to restore drainage such as removing obstructions of debris from the forebay, clearing underdrains or repairing/replacing clogged sand bed.	<ul style="list-style-type: none"> <li>• Inspect monthly and after every 0.5-inch or larger storm event. If standing water is observed, increase inspection frequency to after every 0.1-inch or larger storm event.</li> <li>• Maintain when needed.</li> </ul>
Clogged sand bed  This is indicated when the drain time of the surface of the sand bed exceeds 24-96 hours.	Remove and properly dispose sand from the top of the sand bed (approximately 2 inches of sand, or as much as needed to restore flow). Restore sand depth to the design depth.	<ul style="list-style-type: none"> <li>• Inspect monthly and after every 0.5-inch or larger storm event. If standing water is observed, increase inspection frequency to after every 0.1-inch or larger storm event.</li> <li>• Maintain when needed.</li> </ul>
Obstructed inlet or outlet structure	Clear blockage.	<ul style="list-style-type: none"> <li>• Inspect monthly and after every 0.5-inch or larger storm event.</li> <li>• Remove any accumulated materials found at each inspection.</li> </ul>

Threshold/Indicator	Maintenance Action	Typical Maintenance Frequency
<p>Presence of mosquitos/larvae</p> <p>For images of egg rafts, larva, pupa, and adult mosquitos, see <a href="http://www.mosquito.org/biology">http://www.mosquito.org/biology</a></p>	<p>If mosquitos/larvae are observed: first, immediately remove and properly dispose any standing water by dispersing to nearby landscaping; second, make corrective measures as applicable to restore BMP drainage to prevent standing water.</p> <p>If mosquitos persist following corrective measures to remove standing water, the City Engineer shall be contacted to determine a solution. A different BMP type, or a Vector Management Plan prepared with concurrence from the County of San Diego Department of Environmental Health, may be required.</p>	<ul style="list-style-type: none"> <li>• Inspect monthly and after every 0.5-inch or larger storm event. If mosquitos are observed, increase inspection frequency to after every 0.1-inch or larger storm event.</li> <li>• Maintain when needed</li> </ul>
<p>Damage to structural components of the BMP such as weirs, underdrains, inlet or outlet structures</p>	<p>Repair or replace as applicable.</p>	<ul style="list-style-type: none"> <li>• Inspect annually.</li> <li>• Maintain when needed.</li> </ul>

## E.24 FT-4 Dry Extended Detention Basin



---

**MS4 Permit Category**

---

Flow-thru Treatment Control

---

**Manual Category**

---

Flow-thru Treatment Control

---

**Applicable Performance Standard**

---

Pollutant Control

Flow Control

---

**Primary Benefits**

---

Treatment

Volume Reduction (Incidental)

Peak Flow Attenuation

*Location: Rolling Hills Ranch, Chula Vista, California; Photo Credit: Eric Mosolgo*

---

**Description**

---

Dry extended detention basins are basins that have been designed to detain storm water for an extended period to allow sedimentation and typically drain completely between storm events. A portion of the dissolved pollutant load may also be removed by filtration, uptake by vegetation, and/or through infiltration. The slopes, bottom, and forebay of dry extended detention basins are typically vegetated. Considerable storm water volume reduction can occur in dry extended detention basins when they are located in permeable soils and are not lined with an impermeable barrier. Dry extended detention basins are generally appropriate for developments of ten acres or larger, and have the potential for multiple uses including parks, playing fields, tennis courts, open space, and overflow parking lots. They can also be used to provide flow control by modifying the outlet control structure and providing additional detention storage.

Typical dry extended detention basins components include:

- Forebay for pretreatment
- Surface ponding for captured flows
- Vegetation selected based on basin use, climate, and ponding depth
- Low flow channel, outlet, and overflow device
- Impermeable liner or uncompacted native soils at the bottom of the facility

## E.24: FT-4 Dry Extended Detention Basin

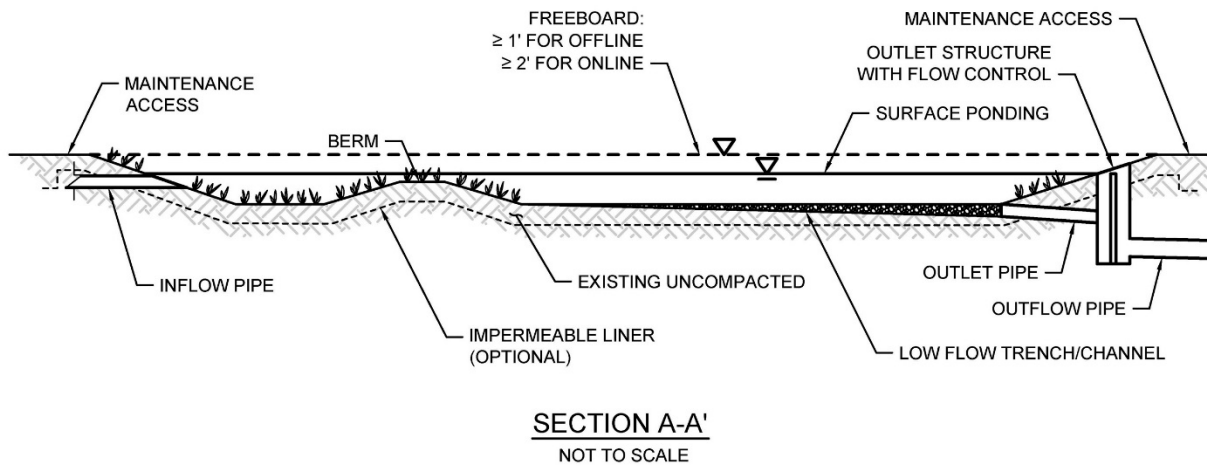
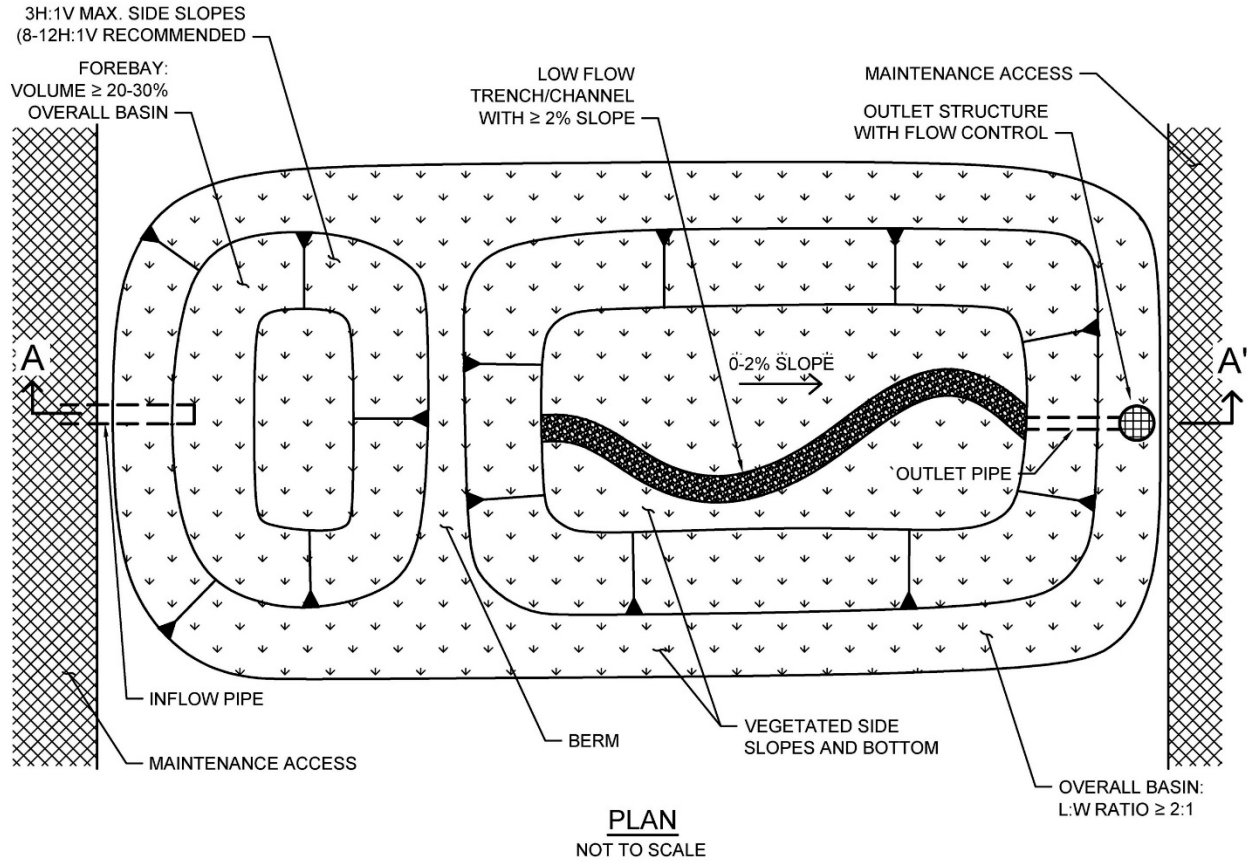

Typical plan and Section view of a Dry Extended Detention Basin BMP

**Design Adaptations for Project Goals**

**Flow-thru treatment BMP for storm water pollutant control.** The system is lined or un-lined to provide incidental infiltration and designed to detain storm water to allow particulates and associated pollutants to settle out. This configuration is considered to provide flow-thru treatment, not biofiltration treatment. Storage provided as surface ponding above a restricted outlet invert is considered detention storage and is included in calculations for the flow-thru treatment volume.

**Integrated storm water flow control and pollutant control configuration.** Dry extended detention basins can also be designed for flow control. The surface ponding can be designed to accommodate higher volumes than the storm water pollutant control volume and can utilize multi-stage outlets to mitigate both the duration and rate of flows within a prescribed range.

**Design Criteria and Considerations**

Dry extended detention basins must meet the following design criteria. Deviations from the below criteria may be approved at the discretion of the City Engineer if it is determined to be appropriate:

<i>Siting and Design</i>	<i>Intent/Rationale</i>
<input type="checkbox"/> Placement observes geotechnical recommendations regarding potential hazards (e.g., slope stability, landslides, and liquefaction zones) and setbacks (e.g., slopes, foundations, utilities).	Must not negatively impact existing site geotechnical concerns.
<input type="checkbox"/> An impermeable liner or other hydraulic restriction layer is included if site constraints indicate that infiltration or lateral flows should not be allowed.	Lining prevents storm water from impacting groundwater and/or sensitive environmental or geotechnical features. Incidental infiltration, when allowable, can aid in pollutant removal and groundwater recharge.
<input type="checkbox"/> Contributing tributary area is large (typically $\geq 10$ acres).	Dry extended detention basins require significant space and are more cost-effective for treating larger drainage areas.
<input type="checkbox"/> Longitudinal basin bottom slope is 0 - 2%.	Flatter slopes promote ponding and settling of particles.
<input type="checkbox"/> Basin length to width ratio is $\geq 2:1$ (L:W).	A larger length to width ratio provides a longer flow path to promote settling.
<input type="checkbox"/> Forebay is included that encompasses 20 - 30% of the basin volume.	A forebay to trap sediment can decrease frequency of required maintenance.

<i>Siting and Design</i>	<i>Intent/Rationale</i>
<input type="checkbox"/> Side slopes are $\geq 3H:1V$ .	Gentler side slopes are safer, less prone to erosion, able to establish vegetation more quickly and easier to maintain.
<input type="checkbox"/> Surface ponding drawdown time is between 24 and 96 hours.	Minimum drawdown time of 24 hours allows for adequate settling time and maximizes pollutant removal. Maximum drawdown time of 96 hours provides vector control.
<input type="checkbox"/> Minimum freeboard provided is $\geq 1$ foot for offline facilities and $\geq 2$ feet for online facilities.	Freeboard provides room for head over overflow structures and minimizes risk of uncontrolled surface discharge.
<input type="checkbox"/> Inflow and outflow structures are accessible by required equipment (e.g., vector truck) for inspection and maintenance.	Maintenance will prevent clogging and ensure proper operation of the flow control structures.
<input type="checkbox"/> A low flow channel or trench with a $\geq 2\%$ slope is provided. A gravel infiltration trench is provided where infiltration is allowable.	Aids in draining or infiltrating dry weather flows.
<input type="checkbox"/> Overflow is safely conveyed to a downstream storm drain system or discharge point. Size overflow structure to pass 100-year peak flow.	Planning for overflow lessens the risk of property damage due to flooding.
<input type="checkbox"/> The maximum rate at which runoff is discharged is set below the erosive threshold for the site.	Extended low flows can have erosive effects.

**Conceptual Design and Sizing Approach for Storm Water Pollutant Control Only**

To design dry extended detention basins for storm water pollutant control only (no flow control required), the following steps should be taken:

1. Verify that siting and criteria have been met, including placement requirements, contributing tributary area, forebay volume, and maximum slopes for basin sides and bottom.
2. Calculate the DCV per Appendix B based on expected site design runoff for tributary areas.
3. Use the sizing worksheet to determine flow-thru treatment sizing of the surface ponding of the dry extended detention basin, which includes calculations for a maximum 96-hour drawdown time.

### **Conceptual Design and Sizing Approach when Storm Water Flow Control is Applicable**

Control of flow rates and/or durations will typically require significant surface ponding volume, and therefore the following steps should be taken prior to determination of storm water pollutant control design. Pre-development and allowable post-project flow rates and durations should be determined as discussed in Chapter 6 of the manual.

1. Verify that siting and criteria have been met, including placement requirements, tributary area, and maximum slopes for basin sides and bottom.
2. Iteratively determine the surface ponding required to provide detention storage to reduce flow rates and durations to allowable limits. Flow rates and durations can be controlled from detention storage by altering outlet structure orifice size(s) and/or water control levels. Multi-level orifices can be used within an outlet structure to control the full range of flows.
3. If a dry extended detention basin cannot fully provide the flow rate and duration control required by this manual, an upstream or downstream structure with appropriate storage volume such as an additional basin or underground vault can be used to provide remaining controls.
4. After the dry extended detention basin has been designed to meet flow control requirements, calculations must be completed to verify if storm water pollutant control requirements to treat the DCV have been met.

### **Maintenance Overview**

**Normal Expected Maintenance.** Dry extended detention basins require routine maintenance to: remove accumulated materials such as sediment, trash or debris; maintain vegetation health; and maintain integrity of side slopes, inlets, energy dissipators, and outlets. A summary table of standard inspection and maintenance indicators is provided within this Fact Sheet.

**Non-Standard Maintenance or BMP Failure.** If any of the following scenarios are observed, the BMP is not performing as intended to protect downstream waterways from pollution and/or erosion. Corrective maintenance, increased inspection and maintenance, BMP replacement, or a different BMP type will be required.

- The BMP is not drained between storm events. Surface ponding longer than approximately 24 hours following a storm event may be detrimental to vegetation health, and surface or underground ponding longer than approximately 96 hours following a storm event poses a risk of vector (mosquito) breeding. Poor drainage can result from clogging of underlying native soils and/or the outlet structure. The specific cause of the drainage issue must be determined and corrected. If it is determined that the drainage of the basin relies on infiltration and the underlying native soils have been compacted or do not have the infiltration capacity expected, the City Engineer shall be contacted prior to any additional repairs or reconstruction.
- Sediment, trash, or debris accumulation greater than 25% of the surface ponding volume

## E.24: FT-4 Dry Extended Detention Basin

within one month. This means the load from the tributary drainage area is too high, reducing BMP function or clogging the BMP. This would require pretreatment measures within the tributary area draining to the BMP to intercept the materials.

- Erosion due to concentrated storm water runoff flow that is not readily corrected by adding erosion control blankets, adding stone at flow entry points, or minor re-grading to restore proper drainage according to the original plan. If the issue is not corrected by restoring the BMP to the original plan and grade, the City Engineer shall be contacted prior to any additional repairs or reconstruction.

**Other Special Considerations.** Some above-ground dry extended detention basins are vegetated structural BMPs. Vegetated structural BMPs that are constructed in the vicinity of, or connected to, an existing jurisdictional water or wetland could inadvertently result in creation of expanded waters or wetlands. As such, vegetated structural BMPs have the potential to come under the jurisdiction of the United States Army Corps of Engineers, SDRWQCB, California Department of Fish and Wildlife, or the United States Fish and Wildlife Service. This could result in the need for specific resource agency permits and costly mitigation to perform maintenance of the structural BMP. Along with proper placement of a structural BMP, routine maintenance is key to preventing this scenario.

Underground dry extended detention basins are typically designed to be cleaned from above-ground using a vactor. If maintenance conditions require maintenance personnel to enter the underground structure, the maintenance personnel must be trained and certified in confined space entry.

**Sediment Loading.** Consider the effects of BMP design and tributary area land uses on the clogging potential of the BMP. Complete the sediment loading analysis included in Appendix E.27.



**Summary of Standard Inspection and Maintenance**

The property owner is responsible to ensure inspection, operation and maintenance of permanent BMPs on their property unless responsibility has been formally transferred to an agency, community facilities district, homeowners association, property owners association, or other special district.

Maintenance frequencies listed in this table are average/typical frequencies. Actual maintenance needs are site-specific, and maintenance may be required more frequently. Maintenance must be performed whenever needed, based on maintenance indicators presented in this table. The BMP owner is responsible for conducting regular inspections to see when maintenance is needed based on the maintenance indicators. During the first year of operation of a structural BMP, inspection is recommended at least once prior to August 31 and then monthly from September through May. Inspection during a storm event is also recommended. After the initial period of frequent inspections, the minimum inspection and maintenance frequency can be determined based on the results of the first year inspections.

Threshold/Indicator	Maintenance Action	Typical Maintenance Frequency
Accumulation of sediment, litter, or debris in forebay and/or basin	Remove and properly dispose of accumulated materials, (without damage to vegetation when applicable).	<ul style="list-style-type: none"> <li>• Inspect monthly. If the forebay is 25% full* or more in one month, increase inspection frequency to monthly plus after every 0.1-inch or larger storm event.</li> <li>• Remove any accumulated materials found within the basin area at each inspection.</li> <li>• When the BMP includes a forebay, materials must be removed from the forebay when the forebay is 25% full*, or if accumulation within the forebay blocks flow to the basin.</li> </ul>
Obstructed inlet or outlet structure	Clear blockage.	<ul style="list-style-type: none"> <li>• Inspect monthly and after every 0.5-inch or larger storm event.</li> <li>• Remove any accumulated materials found at each inspection.</li> </ul>

E.24: FT-4 Dry Extended Detention Basin

Threshold/Indicator	Maintenance Action	Typical Maintenance Frequency
Poor vegetation establishment (when the BMP includes vegetated surface by design)	Re-seed, re-plant, or re-establish vegetation per original plans.	<ul style="list-style-type: none"> <li>• Inspect monthly.</li> <li>• Maintain when needed.</li> </ul>
Dead or diseased vegetation (when the BMP includes vegetated surface by design)	Remove dead or diseased vegetation, re-seed, re-plant, or re-establish vegetation per original plans.	<ul style="list-style-type: none"> <li>• Inspect monthly.</li> <li>• Maintain when needed.</li> </ul>
Overgrown vegetation (when the BMP includes vegetated surface by design)	Mow or trim as appropriate.	<ul style="list-style-type: none"> <li>• Inspect monthly.</li> <li>• Maintain when needed.</li> </ul>
Erosion due to concentrated irrigation flow	Repair/re-seed/re-plant eroded areas and adjust the irrigation system.	<ul style="list-style-type: none"> <li>• Inspect monthly.</li> <li>• Maintain when needed.</li> </ul>
Erosion due to concentrated storm water runoff flow	Repair/re-seed/re-plant eroded areas, and make appropriate corrective measures such as adding erosion control blankets, adding stone at flow entry points, or minor re-grading to restore proper drainage according to the original plan. If the issue is not corrected by restoring the BMP to the original plan and grade, the City Engineer shall be contacted prior to any additional repairs or reconstruction.	<ul style="list-style-type: none"> <li>• Inspect after every 0.5-inch or larger storm event. If erosion due to storm water flow has been observed, increase inspection frequency to after every 0.1-inch or larger storm event.</li> <li>• Maintain when needed. If the issue is not corrected by restoring the BMP to the original plan and grade, the City Engineer shall be contacted prior to any additional repairs or reconstruction.</li> </ul>

E.24: FT-4 Dry Extended Detention Basin

Threshold/Indicator	Maintenance Action	Typical Maintenance Frequency
<p>Standing water in above-ground BMP for longer than 24-96 hours following a storm event</p>	<p>Make appropriate corrective measures such as adjusting irrigation system, removing obstructions of debris or invasive vegetation, or removing/replacing clogged or compacted surface treatments and/or scarifying or tilling native soils. Always remove deposited sediments before scarification, and use a hand-guided rotary tiller. If it is determined that the drainage of the basin relies on infiltration and the underlying native soils have been compacted or do not have the infiltration capacity expected, the City Engineer shall be contacted prior to any additional repairs or reconstruction.</p>	<ul style="list-style-type: none"> <li>• Inspect monthly and after every 0.5-inch or larger storm event. If standing water is observed, increase inspection frequency to after every 0.1-inch or larger storm event.</li> <li>• Maintain when needed.</li> </ul>
<p>Standing water in underground BMP for longer than 24-96 hours following a storm event</p>	<p>Make appropriate corrective measures such as removing obstructions at the outlet, clearing underdrains, or flushing fine sediment from aggregate layer when applicable. If it is determined that the drainage of the basin relies on infiltration and the underlying native soils have been compacted or do not have the infiltration capacity expected, the City Engineer shall be contacted prior to any additional repairs or reconstruction.</p>	<ul style="list-style-type: none"> <li>• Inspect monthly and after every 0.5-inch or larger storm event. If standing water is observed, increase inspection frequency to after every 0.1-inch or larger storm event.</li> <li>• Maintain when needed.</li> </ul>

E.24: FT-4 Dry Extended Detention Basin

Threshold/Indicator	Maintenance Action	Typical Maintenance Frequency
<p>Presence of mosquitos/larvae</p> <p>For images of egg rafts, larva, pupa, and adult mosquitos, see <a href="http://www.mosquito.org/biology">http://www.mosquito.org/biology</a></p>	<p>If mosquitos/larvae are observed: first, immediately remove and properly dispose any standing water; second, make corrective measures as applicable to restore BMP drainage to prevent standing water. For underground detention basins, ensure access covers are tight fitting, with gaps or holes no greater than 1/16 inch, and/or install barriers such as inserts or screens that prevent mosquito access to the subsurface storage.</p> <p>If mosquitos persist following corrective measures to remove standing water, or if the BMP design does not meet the 96-hour drawdown criteria due to release rates controlled by an orifice installed on the underdrain, the City Engineer shall be contacted to determine a solution. A different BMP type, or a Vector Management Plan prepared with concurrence from the County of San Diego Department of Environmental Health, may be required.</p>	<ul style="list-style-type: none"> <li>• Inspect monthly and after every 0.5-inch or larger storm event. If mosquitos are observed, increase inspection frequency to after every 0.1-inch or larger storm event.</li> <li>• Maintain when needed</li> </ul>
<p>Damage to structural components such as weirs, inlet or outlet structures</p>	<p>Repair or replace as applicable.</p>	<ul style="list-style-type: none"> <li>• Inspect annually.</li> <li>• Maintain when needed.</li> </ul>

“25% full” is defined as ¼ of the depth from the design bottom elevation to the crest of the outflow structure (e.g., if the height to the outflow opening is 12 inches from the bottom elevation, then the materials must be removed when there is 3 inches of accumulation – this should be marked on the outflow structure).

## E.25 FT-5 Proprietary Flow-Thru Treatment Control BMPs

The purpose of this fact sheet is to help explain the potential role of proprietary BMPs in meeting flow thru treatment control BMP requirements. The fact sheet does not describe design criteria like the other fact sheets in this appendix because this information varies by BMP product model.

### ***Criteria for Use of a Proprietary BMP as a Flow-Thru Treatment Control BMP***

A proprietary BMP may be acceptable as a “flow-thru treatment control BMP” under the following conditions:

- (1) The BMP is selected and sized consistent with the method and criteria described in Appendix B.6;
- (2) The BMP is designed and maintained in a manner consistent with its performance certifications (See explanation in Appendix B.6); and
- (3) The BMP is acceptable at the discretion of the City Engineer. In determining the acceptability of a BMP, the City Engineer should consider, as applicable, (a) the data submitted; (b) representativeness of the data submitted; (c) consistency of the BMP performance claims with pollutant control objectives; certainty of the BMP performance claims; (d) for projects within the public right of way and/or public projects: maintenance requirements, cost of maintenance activities, relevant previous local experience with operation and maintenance of the BMP type, ability to continue to operate the system in event that the vending company is no longer operating as a business; and (e) other relevant factors. If a proposed BMP is not accepted by the City Engineer, a written explanation/reason will be provided to the applicant.

### ***Guidance for Sizing Proprietary BMPs***

Proprietary flow-thru BMPs must meet the same sizing guidance as other flow-thru treatment control BMPs. Guidance for sizing flow-thru BMPs to comply with requirements of this manual is provided in Appendix B.6.

### ***Maintenance Overview***

Refer to manufacturer for maintenance information.

E.26 PL Plant List

Plant Name		Irrigation Requirements		Preferred Location in Basin		Applicable Bioretention Sections (Un-Lined Facilities)				Applicability to No Infiltration/Lined Facilities?	
Latin Name	Common Name	Temporary Irrigation during Plant Establishment Period	Permanent Irrigation (Drip / Spray) <sup>(1)</sup>	Basin Bottom	Basin Side Slopes	Pollutant Control-Only Bioretention in Hydrologic Soil Group A or B Soils	Pollutant Control-Only Bioretention in Hydrologic Soil Group C or D soils	Pollutant Control Plus Hydromod Flow Control Bioretention in Hydrologic Soil Group A or B Soils	Pollutant Control Plus Hydromod Flow Control Bioretention in Hydrologic Soil Group C or D Soils	NO Applicable to Un-lined Facilities Only (Bioretention/Partial Retention Only)	YES Can Use in Lined or Un-Lined Facility (Flow-Through Planter OR Biofiltration)
<b>TREES<sup>(2)</sup></b>											
Alnus rhombifolia	White Alder	X		X	X	X	X	X	X	X	
Platanus racemosa	California Sycamore	X		X	X	X	X	X	X	X	
Salix lasiolepis	Arroyo Willow	X			X	X	X	X	X	X	
Salix lucida	Lance-Leaf Willow	X			X	X	X	X	X	X	
Sambucus mexicana	Blue Elderberry	X			X	X	X	X	X	X	
<b>SHRUBS / GROUNDCOVER</b>											
Achillea millefolium	Yarrow	X			X	X	X				X
Agrostis palens	Thingrass	X			X	X	X	X	X		X
Anemopsis californica	Yerba Manza	X			X	X	X	X	X		X
Baccharis douglasii	Marsh Baccahris	X	X	X		X	X	X	X		X
Carex praegracillis	California Field Sedge	X	X	X		X	X	X	X		X
Carex spissa	San Diego Sedge	X	X	X		X	X	X	X		X
Carex subfusca	Rusty Sedge	X	X	X	X	X	X	X	X		X
Distichlis spicata	Salt Grass	X	X	X		X	X	X	X		X
Eleocharis macrostachya	Pale Spike Rush	X	X	X		X	X	X	X		X
Festuca rubra	Red Fescue	X	X	X	X	X	X				X
Festuca californica	California Fescue	X	X		X	X	X				X
Iva hayesiana	Hayes Iva	X			X	X	X				X
Juncus Mexicana	Mexican Rush	X	X	X	X	X	X	X	X		X
Jucus patens	California Gray Rush	X	X	X	X	X	X	X	X		X
Leymus condensatus	Canyon Prince Wild Rye	X	X	X	X	X	X	X	X		X
Mahonia nevinii	Nevin's Barberry	X			X	X	X	X	X		X
Muhlenburgia rigens	Deergrass	X	X	X	X	X	X	X	X		X
Mimulus cardinalis	Scarlet Monkeyflower	X		X	X	X	X				X
Ribes speciosum	Fushia Flowering Goose	X			X	X	X				X
Rosa californica	California Wild Rose	X	X		X	X	X				X
Scirpus cenusus	Low Bullrush	X	X	X		X	X	X	X		X
Sisyrinchium bellum	Blue-eyed Grass	X			X	X	X				X

1. All plants will benefit from some supplemental irrigation during hot dry summer months, particularly those on basin side slopes and further inland.
2. All trees should be planted a min. of 10' away from any drain pipes or structures.

## E.27 SL Sediment Loading

The methodology presented in this fact sheet was developed to assist users in estimating BMP maintenance frequency based on the accumulation of sediment in BMPs over time. Complete Worksheet E.27-1 for each proposed Biofiltration with Partial Retention or Biofiltration BMP whose media area is less than 3% of the contributing area times the adjusted runoff factor. These BMPs shall have a minimum maintenance frequency of 10-years unless otherwise approved by the City Engineer. This worksheet can also be used to:

- Estimate maintenance frequency for BMPs with non-standard dimensions and components (i.e. not specified or outside of recommended ranges presented in BMP-specific fact sheets),
- Estimate maintenance frequency for BMPs with a high risk of clogging (either due to tributary area landuse or design BMP loading rates), and
- Design BMPs with a longer, or shorter, expected useful life based on project/owner specific maintenance preferences.

### ***Detailed Clogging Methodology***

---

#### **1. Estimate the sediment load discharging to the BMP.**

The first step in determining the maintenance period for a BMP is to quantify the sediment loading to the BMP. Sediment loading is a function of the land uses in the tributary area draining to the BMP, the volume of runoff routed through the BMP, and the effectiveness of the BMP itself and any pretreatment mechanisms in removing incoming sediment.

Calculate the following:

- Average TSS in tributary area runoff:

Determine the amount of sediment in water draining to the BMP based on the types of upstream land uses. Certain land uses and covers are expected to generate more sediment in storm water runoff than others. Data for TSS concentrations using event mean concentrations (EMCs) for a range of land uses are summarized in the table below. Determine an area weighted EMC for the BMP tributary area if it contains multiple land uses.

Land Use	TSS EMC <sup>20</sup> , mg/L
Single Family Residential	123
Commercial	128
Industrial	125
Education (Municipal)	132
Transportation <sup>21</sup>	78
Multi-family Residential	40
Roof Runoff <sup>22</sup>	14
Low Traffic Areas <sup>23</sup>	50
Open Space <sup>2</sup>	216
Steep Hillslopes (i.e. greater than 25% slopes; natural/landscaped) <sup>24</sup>	797

- Average TSS in BMP influent:

Determine the sediment concentration in storm water draining through the BMP by reducing the average TSS calculated through the area weighted method by the efficiency of any upstream pretreatment devices. Calculate the BMP influent concentration using the following formula:

$$TSS_{\text{influent}} = TSS_{\text{avg}} \times (1 - \text{Pretreatment Removal Efficiency})$$

Where:

Pretreatment Removal Efficiency = 0 if no pretreatment;

Pretreatment Removal Efficiency = 0.25 when pretreatment is included;

Pretreatment Removal Efficiency = 0.5 if good pretreatment is included. Performance of pretreatment is consistent with Washington TAPE “Pre-treatment” BMP performance criteria (>50% TSS removal; refer to Appendix B.6); and

Pretreatment Removal Efficiency = 0.8 if excellent pretreatment is included. Performance of pretreatment consistent with Washington TAPE “Basic Treatment” BMP performance criteria (>80% TSS removal; refer to Appendix B.6).

<sup>20</sup> EMCs are from (Structural BMP Prioritization and Analysis Tool) SBPAT datasets for San Luis Rey and San Diego River Watersheds – Arithmetic Estimates of the Lognormal Summary Statistics for San Diego, unless otherwise noted.

<sup>21</sup> EMCs are based on Los Angeles region default SBPAT datasets due to lack of available San Diego data.

<sup>22</sup> Value represents the average first flush concentration for roof runoff (Charters et al., 2015).

<sup>23</sup> Davis and McCuen (2005)

<sup>24</sup> 95% probability from the EMC dataset using the lognormal distribution.



- Annual sediment discharging to the BMP:

Determine the annual sediment load discharging to the BMP using the results of the previous calculations and the following equations.

Average Annual Runoff Volume (cu. ft./yr) = Average annual precipitation x adjusted runoff factor determined in accordance with Appendix B x drainage area

Annual Sediment discharging to the BMP (lb/year) = Annual Runoff Volume x 62.4 x TSS<sub>influent</sub> / 10<sup>6</sup>

**2. Determine available sediment storage in the BMP.**

In the previous step the annual sediment load is calculated in lb/year. This result can be compared against the available sediment storage in the BMP.

For filtration BMPs:

For media type filtration BMPs with a given footprint (e.g. biofiltration BMPs) the load to clog can be estimated using the table below.

BMP Configuration <sup>25</sup>	Load to Clog, L <sub>c</sub> , lb/sq. ft.
Baseline: Approximately 50 percent vegetative cover; typical fine sand and compost blend	2
Baseline + increase vegetative cover to at least 75 percent	3
Baseline + include coarser sand to increase initial permeability to 20 to 30 in/hr; control flowrate with outlet control	3
Baseline + increase vegetative cover and include more permeable media with outlet control, per above	4

Then available sediment storage can be estimated using the following equation:

$$\text{Available Sediment Storage (lb)} = \text{Load to Clog (lb/sq. ft.)} \times \text{BMP Filtration Area (sq. ft.)}$$

<sup>25</sup> References:

Charters, F.J., Cochrane, T.A., and O’Sullivan, A.D., (2015). Particle Size Distribution Variance in Untreated Urban Runoff and its implication on treatment selection. *Water Research*, 85 (2015), pg. 337-345.

Davis, A.P. and McCuen, R.H., (2005). *Stormwater Management for Smart Growth*. Springer Science & Business Media, pg. 155.

Maniquiz-Redillas, M.C., Geronimo, F.K.F, and Kim, L-H. Investigation on the Effectiveness of Pretreatment in Stormwater Management Technologies. *Journal of Environmental Sciences*, 26 (2014), pg. 1824-1830.

Pitt, R. and Clark, S.E., (2010). *Evaluation of Biofiltration Media for Engineered Natural Treatment Systems*. Geosyntec Consultants and The Boeing Company.

### 3. Estimate frequency of maintenance.

Using the results of Step 1 and Step 2, estimate the frequency of maintenance by dividing the available storage by the annual load.

$$\text{Maintenance Frequency (years)} = \text{Available sediment storage} / \text{Annual Load}$$

The resulting maintenance frequency is the estimated number of years until a BMP clogs and requires rehabilitative (major) maintenance and/or replacement. The result of this equation should not be used to replace good engineering judgment or indications of actual BMP maintenance requirements. Applicants should note that more frequent regular maintenance is still required and follow the recommendations included in the specific BMP factsheets and maintenance fact sheets.

In special cases, it may be appropriate and beneficial to account for extreme event or non-storm water sediment loads to a BMP. This may be the case if visual observations indicate that a large quantity of sediment has been deposited into a BMP during a single event or if there is a reasonably quantifiable amount of sediment has been deposited by other means. This can help the owner/operator of the BMP update their maintenance schedule appropriately. To determine the sediment load from a single event, the Modified Universal Soil Loss Equation (MUSLE) can be applied. In some cases, visual observations of sediment accumulation, when compared to a regularly recorded benchmark such as a sediment or stage gauge, can be used to identify and quantify the effect of sediment loading.

Worksheet E.27-1.: Sediment Loading Maintenance Frequency

Maintenance Frequency: Sediment Loading		Worksheet E.27-1	
1	Area draining to the BMP		sq. ft.
2	Adjusted Runoff Factor for drainage area (Refer to Appendix B.1 and B.2)		
<b>Step 1: Sediment Load Discharging to the BMP</b>			
Land Use	Fraction of Total DCV	TSS EMC (mg/L)	Product
Single Family Residential		123	
Commercial		128	
Industrial		125	
Education (Municipal)		132	
Transportation		78	
Multi-family Residential		40	
Roof Runoff		14	
Low Traffic Areas		50	
Open Space		216	
Steep Hillslopes (i.e. greater than 25% slopes; natural/landscaped)		797	
Other, specify:			
Other, specify:			
3	Volume Weighted EMC (sum of all products)		mg/L
4	Adjustment for pretreatment measures  Where: Line 4 = 0 if no pretreatment; Line 4 = 0.25 when pretreatment is included; Line 4 = 0.5 if the pretreatment has an active Washington State TAPE approval rating for “pre-treatment.”; Line 4 = 0.8 if the pretreatment has an active Washington State TAPE approval rating for “basic treatment.”		
5	Average TSS in BMP Influent [Line 3 x (1-Line 4)]		mg/L
6	Average Annual Precipitation [Provide documentation of the data source in the discussion box; SanGIS has a GIS layer for average annual precipitation]		inches

Maintenance Frequency: Sediment Loading		Worksheet E.27-1	
7	Calculate the Average Annual Runoff (Line 6/12) x Line 1 x Line 2		cu-ft/yr
8	Calculate the Average Annual TSS Load (Line 7 x 62.4 x Line 5)/10 <sup>6</sup>		lb/yr
<b>Step 2: Available Sediment Storage</b>			
9	BMP Filtration Area		sq. ft.
10	Load to Clog (default value when using Appendix E fact sheets is 2.0)		lb/sq. ft.
11	Dead Storage in the BMP for sediment accumulation		cu-ft
12	Available Sediment Storage For filtration BMPs = Line 9 x Line 10 For Settling BMPs = Line 11 x 62.4		lb
<b>Step 3: Frequency of Maintenance</b>			
13	Calculate the Frequency of Maintenance [ Line 12/ Line 8]		years
Discussion:			

Appendix

F

ESCONDIDO STORM WATER DESIGN MANUAL

# Biofiltration Standard and Checklist

# Appendix F Biofiltration Standard and Checklist

## Introduction

The MS4 Permit and this manual define a specific category of storm water pollutant treatment BMPs called “biofiltration BMPs.” The MS4 Permit (Section E.3.c.1) states:

**Biofiltration BMPs must be designed to have an appropriate hydraulic loading rate to maximize storm water retention and pollutant removal, as well as to prevent erosion, scour, and channeling within the BMP, and must be sized to:**

- a) **Treat 1.5 times the DCV not reliably retained onsite, OR**
- b) **Treat the DCV not reliably retained onsite with a flow-thru design that has a total volume, including pore spaces and pre-filter detention volume, sized to hold at least 0.75 times the portion of the DCV not reliably retained onsite.**

A project applicant must be able to affirmatively demonstrate that a given BMP is designed and sized in a manner consistent with this definition to be considered as a “biofiltration BMP” as part of a compliant storm water management plan. Retention is defined in the MS4 Permit as evapotranspiration, infiltration, and harvest and use of storm water vs. discharge to a surface water system.

## Contents and Intended Uses

This appendix contains a checklist of the key underlying criteria that must be met for a BMP to be considered a biofiltration BMP. The purpose of this checklist is to facilitate consistent review and approval of biofiltration BMPs that meet the “biofiltration standard” defined by the MS4 Permit.

This checklist includes specific design criteria that are essential to defining a system as a biofiltration BMP; however it does not present a complete design basis. This checklist was used to develop BMP Fact Sheets for PR-1 biofiltration with partial retention and BF-1 biofiltration, which do present a complete design basis. Therefore, biofiltration BMPs that substantially meet all aspects of the Fact sheets PR-1 or BF-1 should be able to complete this checklist without additional documentation beyond what would already be required for a project submittal.

## Appendix F: Biofiltration Standard and Checklist

Other biofiltration BMP designs<sup>26</sup> (including both non-proprietary and proprietary designs) may also meet the underlying MS4 Permit requirements to be considered biofiltration BMPs. These BMPs may be classified as biofiltration BMPs if they (1) meet the minimum design criteria listed in this appendix, including the pollutant treatment performance standard in Appendix F.1, (2) are designed and maintained in a manner consistent with their performance certifications (See explanation in Appendix F.2), if applicable, and (3) are acceptable at the discretion of the City Engineer. The applicant may be required to provide additional studies and/or required to meet additional design criteria beyond the scope of this document in order to demonstrate that these criteria are met.

### Organization

The checklist in this appendix is organized into the seven (7) main objectives associated with biofiltration BMP design. It describes the associated minimum criteria that must be met in order to qualify a biofiltration BMP as meeting the biofiltration standard. The seven main objectives are listed below. Specific design criteria and associated manual references associated with each of these objectives is provided in the checklist in the following section.

1. Biofiltration BMPs shall be allowed only as described in the BMP selection process in this manual (i.e., retention feasibility hierarchy).
2. Biofiltration BMPs must be sized using acceptable sizing methods described in this manual.
3. Biofiltration BMPs must be sited and designed to achieve maximum feasible infiltration and evapotranspiration.
4. Biofiltration BMPs must be designed with a hydraulic loading rate to maximize pollutant retention, preserve pollutant control/sequestration processes, and minimize potential for pollutant washout.
5. Biofiltration BMPs must be designed to promote appropriate biological activity to support and maintain treatment processes.
6. Biofiltration BMPs must be designed to prevent erosion, scour, and channeling within the BMP.

---

<sup>26</sup> Defined as biofiltration designs that do not conform to the specific design criteria described in Fact Sheets PR-1 or BF-1. This category includes proprietary BMPs that are sold by a vendor as well as non-proprietary BMPs that are designed and constructed of primarily of more elementary construction materials.

7. Biofiltration BMP must include operations and maintenance design features and planning considerations to provide for continued effectiveness of pollutant and flow control functions.

## Biofiltration Criteria Checklist

The applicant shall provide documentation of compliance with each criterion in this checklist as part of the project submittal. The right column of this checklist identifies the submittal information that is recommended to document compliance with each criterion. Biofiltration BMPs that substantially meet all aspects of Fact Sheets PR-1 or BF-1 should still use this checklist; however additional documentation (beyond what is already required for project submittal) should not be required.

---

**1. Biofiltration BMPs shall be allowed to be used only as described in the BMP selection process based on a documented feasibility analysis.**

Intent: This manual defines a specific prioritization of pollutant treatment BMPs, where BMPs that retain water (retained includes evapotranspired, infiltrated, and/or harvested and used) must be used before considering BMPs that have a biofiltered discharge to the MS4 or surface waters. Use of a biofiltration BMP in a manner in conflict with this prioritization (i.e., without a feasibility analysis justifying its use) is not permitted, regardless of the adequacy of the sizing and design of the system.

- 
- |                          |   |   |
|--------------------------|---|---|
| <input type="checkbox"/> | The project applicant has demonstrated that it is not technically feasible to retain the full DCV onsite. | Document feasibility analysis and findings in SWQMP per Appendix C. |
|--------------------------|---|---|

---

**2. Biofiltration BMPs must be sized using acceptable sizing methods.**

Intent: The MS4 Permit and this manual defines specific sizing methods that must be used to size biofiltration BMPs. Sizing of biofiltration BMPs is a fundamental factor in the amount of storm water that can be treated and also influences volume and pollutant retention processes.

- 
- |                          |  |   |
|--------------------------|--|---|
| <input type="checkbox"/> | The project applicant has demonstrated that biofiltration BMPs are sized to meet one of the biofiltration sizing options available (Appendix B). | Submit sizing worksheets (Appendix B.5) or other equivalent documentation with the SWQMP. |
|--------------------------|--|---|

---

**3. Biofiltration BMPs must be sited and designed to achieve maximum feasible infiltration and evapotranspiration.**

Intent: Various decisions about BMP placement and design influence how much water is retained via infiltration and evapotranspiration. The MS4 Permit requires that biofiltration BMPs achieve maximum feasible retention (evapotranspiration and infiltration) of storm water volume.

---



## Appendix F: Biofiltration Standard and Checklist

<input type="checkbox"/>	The biofiltration BMP is sited to allow for maximum infiltration of runoff volume based on the feasibility factors considered in site planning efforts. It is also designed to maximize evapotranspiration through the use of amended media and plants.	Document site planning and feasibility analyses in SWQMP per Section 5.4..
<input type="checkbox"/>	The biofiltration BMP meets the annual retention target specified in Appendix B.	Included documentation that the annual retention target is met.
<p><b>4. Biofiltration BMPs must be designed with a hydraulic loading rate to maximize pollutant retention, preserve pollutant control processes, and minimize potential for pollutant washout.</b></p> <p>Intent: Various decisions about biofiltration BMP design influence the degree to which pollutants are retained. The MS4 Permit requires that biofiltration BMPs achieve maximum feasible retention of storm water pollutants.</p>		
<input type="checkbox"/>	Media selected for the biofiltration BMP meets minimum quality and material specifications, including the maximum allowable design filtration rate and minimum thickness of media.	Provide documentation that media meets the specifications.
<b>OR</b>		
<input type="checkbox"/>	Alternatively, for proprietary designs and custom media mixes not meeting the media specifications, field scale testing data are provided to demonstrate that proposed media meets the pollutant treatment performance criteria in Section F.1 below.	Provide documentation of performance information as described in Section F.1.
<input type="checkbox"/>	To the extent practicable, filtration rates are outlet controlled (e.g., via an underdrain and orifice/weir) instead of controlled by the infiltration rate of the media.	Include outlet control in designs or provide documentation of why outlet control is not practicable.
<input type="checkbox"/>	The water surface drains to at least 12 inches below the media surface within 24 hours from the end of storm event flow to preserve plant health and promote healthy soil structure.	<p>Include calculations to demonstrate that drawdown rate is adequate.</p> <p>Surface ponding drawdown time greater than 24-hours but less than 96 hours may be allowed at the discretion of the City Engineer if certified by a landscape architect or agronomist.</p>

## Appendix F: Biofiltration Standard and Checklist

<input type="checkbox"/>	If nutrients are a pollutant of concern, design of the biofiltration BMP follows nutrient-sensitive design criteria.	Follow specifications for nutrient sensitive design in Fact Sheet BF-2. Or provide alternative documentation that nutrient treatment is addressed and potential for nutrient release is minimized.
<input type="checkbox"/>	Media gradation calculations or geotextile selection calculations demonstrate that migration of media between layers will be prevented and permeability will be preserved.	Follow specification for choking layer or geotextile in Fact Sheet PR-1 or BF-1. Or include calculations to demonstrate that choking layer is appropriately specified.
<p><b>5. Biofiltration BMPs must be designed to promote appropriate biological activity to support and maintain treatment processes.</b></p> <p>Intent: Biological processes are an important element of biofiltration performance and longevity.</p>		
<input type="checkbox"/>	Plants have been selected to be tolerant of project climate, design ponding depths and the treatment media composition.	Provide documentation justifying plant selection. Refer to the plant list in Appendix E.26.
<input type="checkbox"/>	Plants have been selected to minimize irrigation requirements.	Provide documentation describing irrigation requirements for establishment and long term operation.
<input type="checkbox"/>	Plant location and growth will not impede expected long-term media filtration rates and will enhance long term infiltration rates to the extent possible.	Provide documentation justifying plant selection. Refer to the plant list in Appendix E.26.
<p><b>6. Biofiltration BMPs must be designed with a hydraulic loading rate to prevent erosion, scour, and channeling within the BMP.</b></p> <p>Intent: Erosion, scour, and/or channeling can disrupt treatment processes and reduce biofiltration effectiveness.</p>		
<input type="checkbox"/>	Scour protection has been provided for both sheet flow and pipe inflows to the BMP, where needed.	Provide documentation of scour protection as described in Fact Sheets PR-1 or BF-1 or approved equivalent.
<input type="checkbox"/>	Where scour protection has not been provided, flows into and within the BMP are kept to non-erosive velocities.	Provide documentation of design checks for erosive velocities as described in Fact Sheets PR-1 or BF-1 or approved equivalent.

## Appendix F: Biofiltration Standard and Checklist

- |                          |   |   |
|--------------------------|---|---|
| <input type="checkbox"/> | For proprietary BMPs, the BMP is used in a manner consistent with manufacturer guidelines and conditions of its third-party certification <sup>27</sup> (i.e., maximum tributary area, maximum inflow velocities, etc., as applicable). | Provide copy of manufacturer recommendations and conditions of third-party certification. |
|--------------------------|---|---|

### 7. Biofiltration BMP must include operations and maintenance design features and planning considerations for continued effectiveness of pollutant and flow control functions.

Intent: Biofiltration BMPs require regular maintenance in order provide ongoing function as intended. Additionally, it is not possible to foresee and avoid potential issues as part of design; therefore plans must be in place to correct issues if they arise.

- |                          |  |  |
|--------------------------|--|--|
| <input type="checkbox"/> | The biofiltration BMP O&M plan describes specific inspection activities, regular/periodic maintenance activities and specific corrective actions relating to scour, erosion, channeling, media clogging, vegetation health, and inflow and outflow structures. | Include O&M plan with project submittal as described in Chapter 7.   |
| <input type="checkbox"/> | Adequate site area and features have been provided for BMP inspection and maintenance access.  | Illustrate maintenance access routes, setbacks, maintenance features as needed on project water quality plans. |
| <input type="checkbox"/> | For proprietary biofiltration BMPs, the BMP maintenance plan is consistent with manufacturer guidelines and conditions of its third-party certification (i.e., maintenance activities, frequencies).   | Provide copy of manufacturer recommendations and conditions of third-party certification.                      |

---

<sup>27</sup> Certifications or verifications issued by the Washington Technology Acceptance Protocol-Ecology program and the New Jersey Corporation for Advanced Technology programs are typically accompanied by a set of guidelines regarding appropriate design and maintenance conditions that would be consistent with the certification/verification

### F.1 Pollutant Treatment Performance Standard

Standard biofiltration BMPs that are designed following the criteria in Fact Sheets PR-1 and BF-1 are presumed to meet the pollutant treatment performance standard associated with biofiltration BMPs. This presumption is based on the MS4 Permit Fact Sheet which cites analyses of standard biofiltration BMPs conducted in the Ventura County Technical Guidance Manual (July 2011).

For BMPs that do not meet the biofiltration media specification and/or the range of acceptable media filtration rates described in Fact Sheet, PR-1 and BF-1, additional documentation must be provided to demonstrate that adequate pollutant treatment performance is provided to be considered a biofiltration BMP. Project applicants have three options for documenting compliance:

- 1) Project applicants may provide documentation to substantiate that the minor modifications to the design is expected to provide equal or better pollutant removal performance for the project pollutants of concern than would be provided by a biofiltration design that complies with the criteria in Fact Sheets PR-1 and BF-1. Minor modifications are design elements that deviate only slightly from standard design criteria and are expected to either not impact performance or to improve performance compared to standard biofiltration designs. The reviewing agency has the discretion to accept or reject this documentation and/or request additional documentation to substantiate equivalent or better performance to BF-1 or PR-1, as applicable. Examples of minor deviations include:
  - Different particle size distribution of aggregate, with documentation that system filtration rate will meet specifications.
  - Alternative source of organic components, with documentation of material suitability and stability from appropriate testing agency.
  - Specialized amendments to provide additional treatment mechanisms, and which have negligible potential to upset other treatment mechanisms or otherwise deteriorate performances.
- 2) For proprietary BMPs, project applicants may provide evidence that the BMP has been certified for use as part of the Washington State Technology Assessment Protocol-Ecology certification program and meets each of the following requirements:
  - a. The applicant must demonstrate (using the checklist in this Appendix) that the BMP meets all other conditions to be considered as a biofiltration BMP. For example, a cartridge media filter or hydrodynamic separator would not meet biofiltration BMP design criteria regardless of Technology Acceptance Protocol-Ecology certification

## Appendix F: Biofiltration Standard and Checklist

because they do not support effective biological processes.

- b. The applicant must select BMPs that have an active Technology Acceptance Protocol-Ecology certification, with General Use Level Designation for the appropriate project pollutants of concern as identified in Table F.1-1. The list of certified technologies is updated as new technologies are approved (link below). Technologies with Pilot Use Level Designation and Conditional Use Level Designations are not acceptable. Refer to: <http://www.ecy.wa.gov/programs/wq/stormwater/newtech/technologies.html>.
  - c. The applicant must demonstrate that BMP is being used in a manner consistent with all conditions of the Technology Acceptance Protocol-Ecology certification while meeting the flow rate or volume design criteria that is required for biofiltration BMPs under this manual. Conditions of Technology Acceptance Protocol-Ecology certification are available by clicking on the technology name at the website listed in bullet b. Additional discussion about sizing of proprietary biofiltration BMPs to comply with applicable sizing standards is provided below in Section F.2.
  - d. ~~For~~ For projects within the public right of way and/or public projects: the product must be acceptable to the City Engineer with respect to maintainability and long term operation of the product. In determining the acceptability of a product the City Engineer should consider, as applicable, maintenance requirements, cost of maintenance activities, relevant previous local experience with operation and maintenance of the BMP type, ability to continue to operate the system in event that the vending company is no longer operating as a business, and other relevant factors. If a proposed BMP is not accepted by the City Engineer, a written explanation/reason will be provided to the applicant.
- 3) For BMPs that do not fall into options 1 or 2 above, the City Engineer may allow the applicant to submit alternative third-party documentation that the pollutant treatment performance of the system is consistent with the performance levels associated with the necessary Technology Acceptance Protocol-Ecology certifications. Table F.1-1 describes the required levels of certification and Table F.1-2 describes the pollutant treatment performance levels associated with each level of certification. Acceptance of this approach is at the sole discretion of the City Engineer. If a proposed BMP is not accepted by the City Engineer, a written explanation/reason will be provided to the applicant. If Technology Acceptance Protocol-Ecology certifications are not available, preference shall be given to:
- a. Verified third-party, field-scale testing performance under the Technology Acceptance Reciprocity Partnership Tier II Protocol. This protocol is no longer operated, however this is considered to be a valid protocol and historic verifications are considered to be representative provided that product models being proposed are consistent with those

## Appendix F: Biofiltration Standard and Checklist

that were tested. Technology Acceptance Reciprocity Partnership verifications were conducted under New Jersey Corporation for Advance Testing and are archived at the website linked below. Note that Technology Acceptance Reciprocity Partnership verifications must be matched to pollutant treatment standards in Table F.1-2 then matched to an equivalent Technology Acceptance Protocol-Ecology certification in Table F.1-1.

- b. Verified third-party, field-scale testing performance under the New Jersey Corporation for Advance Testing protocol. Note that New Jersey Corporation for Advance Testing verifications must be matched to pollutant treatment standards in Table F.1-2 then matched to an equivalent Technology Acceptance Protocol-Ecology certification in Table F.1-1.

A list of field-scale verified technologies under Technology Acceptance Reciprocity Partnership Tier II and New Jersey Corporation for Advance Testing can be accessed at: <http://www.njcat.org/verification-process/technology-verification-database.html> (refer to field verified technologies only).

## Appendix F: Biofiltration Standard and Checklist

**Table F.1-1: Required Technology Acceptance Protocol-Ecology Certifications for Pollutants of Concern for Biofiltration Performance Standard**

Project Pollutant of Concern	Required Technology Acceptance Protocol-Ecology Certification for Biofiltration Performance Standard
Trash	Basic Treatment OR Phosphorus Treatment OR Enhanced Treatment
Sediments	Basic Treatment OR Phosphorus Treatment OR Enhanced Treatment
Oil and Grease	Basic Treatment OR Phosphorus Treatment OR Enhanced Treatment
Nutrients	Phosphorus Treatment <sup>1</sup>
Metals	Enhanced Treatment
Pesticides	Basic Treatment (including filtration) <sup>2</sup> OR Phosphorus Treatment OR Enhanced Treatment
Organics	Basic Treatment (including filtration) <sup>2</sup> OR Phosphorus Treatment OR Enhanced Treatment
Bacteria and Viruses	Basic Treatment (including bacteria removal processes) <sup>3</sup> OR Phosphorus Treatment OR Enhanced Treatment

1 – There is no Technology Acceptance Protocol-Ecology equivalent for nitrogen compounds; however systems that are designed to retain phosphorus (as well as meet basic treatment designation), generally also provide treatment of nitrogen compounds. Where nitrogen is a pollutant of concern, relative performance of available certified systems for nitrogen removal should be considered in BMP selection.

2 – Pesticides, organics, and oxygen demanding substances are typically addressed by particle filtration consistent with the level of treatment required to achieve Basic treatment certification; if a system with Basic treatment certification does not provide filtration, it is not acceptable for pesticides, organics or oxygen demanding substances.

3 – There is no Technology Acceptance Protocol-Ecology equivalent for pathogens (viruses and bacteria), and testing data are limited because of typical sample hold times. Systems with Technology Acceptance Protocol-Ecology Basic Treatment must include one or more significant bacteria removal process such as media filtration, physical sorption, predation, reduced redox conditions, and/or solar inactivation. Where design options are available to enhance pathogen removal (i.e., pathogen-specific media mix offered by vendor), this design variation should be used.

**Appendix F: Biofiltration Standard and Checklist**

**Table F.1-2: Performance Standards for Technology Acceptance Protocol-Ecology Certification**

<b>Performance Goal</b>	<b>Influent Range</b>	<b>Criteria</b>
<b>Basic Treatment</b>	20 – 100 mg/L TSS	Effluent goal $\leq$ 20 mg/L TSS
	100 – 200 mg/L TSS	$\geq$ 80% TSS removal
	>200 mg/L TSS	> 80% TSS removal
<b>Enhanced (Dissolved Metals) Treatment</b>	Dissolved copper 0.005 – 0.02 mg/L	Must meet basic treatment goal and better than basic treatment currently defined as >30% dissolved copper removal
	Dissolved zinc 0.02 – 0.3 mg/L	Must meet basic treatment goal and better than basic treatment currently defined as >60% dissolved zinc removal
<b>Phosphorous Treatment</b>	Total phosphorous 0.1 – 0.5 mg/L	Must meet basic treatment goal and exhibit $\geq$ 50% total phosphorous removal
<b>Oil Treatment</b>	Total petroleum hydrocarbon > 10 mg/L	No ongoing or recurring visible sheen in effluent Daily average effluent Total petroleum hydrocarbon concentration < 10 mg/L Maximum effluent Total petroleum hydrocarbon concentration for a 15 mg/L for a discrete (grab) sample
<b>Pretreatment</b>	50 – 100 mg/L TSS	$\leq$ 50 mg/L TSS
	$\geq$ 200 mg/L TSS	$\geq$ 50% TSS removal



## F.2 Guidance on Sizing and Design of Non-Standard Biofiltration BMPs

This section explains the general process for design and sizing of non-standard biofiltration BMPs. This section assumes that the BMPs have been selected based on the criteria in Section F.1.

### F.2.1 Guidance on Design per Conditions of Certification/Verification

The biofiltration standard and checklist in this appendix requires that “the BMP is used in a manner consistent with manufacturer guidelines and conditions of its third-party certification.” Practically, what this means is that the BMP is used in the same way in which it was tested and certified. For example, it is not acceptable for a BMP of a given size to be certified/verified with a 100 gallon per minute treatment rate and be applied at a 150 gallon per minute treatment rate in a design.

Certifications or verifications issued by the Washington Technology Acceptance Protocol-Ecology program and the Technology Acceptance Reciprocity Partnership or New Jersey Corporation for Advance Testing programs are typically accompanied by a set of guidelines regarding appropriate design and maintenance conditions that would be consistent with the certification/verification. It is common for these approvals to specify the specific model of BMP, design capacity for given unit sizes, type of media that is the basis for approval, and/or other parameter. The applicant must demonstrate conclusively that the proposed application of the BMP is consistent with these criteria.

For alternate non-proprietary systems that do not have a Technology Acceptance Protocol-Ecology / Technology Acceptance Reciprocity Partnership / New Jersey Corporation for Advance Testing certification (but which still must provide quantitative data per Appendix F.1), it must be demonstrated that the configuration and design proposed for the project is reasonably consistent with the configuration and design under which the BMP was tested to demonstrate compliance with Appendix F.1.

### F.2.2 Sizing of Flow-Based Biofiltration BMP

**This sizing method is only available when the BMP meets the pollutant treatment performance standard in Appendix F.1.**

Proprietary biofiltration BMPs are typically designed as a flow-based BMPs (i.e., a constant treatment capacity with negligible storage volume). Proprietary biofiltration is only acceptable if the sizing criteria in this Appendix and the retention performance standard identified in Appendix B.5 are satisfied. The applicable sizing method for biofiltration is reduced to: Treat 1.5 times the DCV.

The following steps should be followed to demonstrate that the system is sized to treat 1.5 times the DCV.

1. Calculate the flow rate required to meet the pollutant treatment performance standard without

## Appendix F: Biofiltration Standard and Checklist

scaling for the 1.5 factor. Options include either:

- Calculate the runoff flow rate from a 0.2 inch per hour uniform intensity precipitation event (See methodology Appendix B.6.3), or
  - Conduct a continuous simulation analysis to compute the size required to capture and treat 80 percent of average annual runoff; for small catchments, 5-minute precipitation data should be used to account for short time of concentration. Nearest rain gauge with 5-minute precipitation data is allowed for this analysis.
2. Multiply the flow rate from Step 1 by 1.5 to compute the design flow rate for the biofiltration system.
  3. Based on the conditions of certification/verification (discussed above), establish the design capacity, as a flow rate, of a given sized unit.
  4. Demonstrates that an appropriate unit size and number of units is provided to provide a flow rate that meets the required flow rate from Step 2.
  5. Provide supplemental retention BMPs that will meet the volume retention performance standard in Appendix B.

## F.3 Bioretention Soil Media (BSM)

The Green Book formatted specification provided below was developed following a survey and analysis of regional BSM material providers. Section numbering in this Appendix follows the Green Book format. Bioretention Soil Media used in Bioretention, Biofiltration with Partial Retention, and Biofiltration BMPs shall meet the requirements of this specification.

### **SECTION 803 - BIORETENTION SOIL MEDIA COMPOSITION, TESTING, AND INSTALLATION**

#### **803-1 GENERAL.**

Bioretention Soil Media (BSM) is intended to filter storm water and support plant growth while minimizing the leaching of potential pollutants. This specification includes requirements that apply to BSM used in stormwater treatment BMPs, including bioretention and biofiltration.

#### **803-2 BLENDED BSM CRITERIA AND TESTING REQUIREMENTS**

**803-2.1 General.** Blended BSM shall consist of 60% to 80% by volume sand, up to 20% by volume topsoil, and up to 20% by volume compost. Sand, Topsoil, and Compost used in BSM shall conform to requirements listed in Sections 803-3, 803-4, and 803-5, respectively. For bioretention/biofiltration with outlet-controlled designs, it is likely that topsoil will need to be omitted or reduced to achieve permeability targets.

Alternative mix components and proportions may be utilized, provided that the whole blended mix conforms to whole BSM criteria, detailed in Section 803-2.3 through 803-2.5. Alternative mix designs may include alternative proportions and/or alternative organic amendments. Alternative mixes are subject to approval by the reviewing jurisdiction. Alternative mixes that use an alternative organic component (rather than compost) may be necessary when BMPs are installed in areas with nitrogen or phosphorus impaired receiving waters in order to meet more stringent BSM quality requirements as detailed in Section 803-2.5.

**803-2.2 Testing and Submittals.** At least 30 days prior to ordering materials, the Contractor shall submit the following to the local jurisdiction reviewer (upon request): source/supplier of BSM, location of source/supplier, a physical sample of the BSM, whole BSM test results from a third party independent laboratory, test results for individual component materials as required, and description of proposed methods and schedule for mixing, delivery, and placement of BSM. The test results shall be no older than 120 days and shall accurately represent the materials and feed stocks that are currently available from the supplier.

Test results shall demonstrate conformance to agronomic suitability and hydraulic suitability criteria

## Appendix F: Biofiltration Standard and Checklist

listed in Sections 803-2.3 and 803-2.4, respectively. BSM for use in BMPs in areas with water quality impairments in receiving waters shall also comply with applicable Chemical Suitability criteria in Section 803-2.5. No delivery, placement, or planting of BSM shall begin until test results confirm the suitability of the BSM. The Contractor shall submit a written request for approval which shall be accompanied by written analysis results from a written report of a testing agency. The testing agency must be registered by the State for agronomic soil evaluation laboratory test fees shall be paid for by the Contractor.

**803-2.3 Agronomic Suitability.** The BSM shall conform to the requirements herein to support plant growth. BSM which requires amending to comply with the below specifications shall be uniformly blended and tested in its blended state prior to testing and delivery.

- a) pH range shall be between 6.0-8.5
- b) Salinity shall be between 0.5 and 3.0 millimho/cm (as measure by electrical conductivity)
- c) Sodium absorption ratio (SAR) shall be less than 5.0
- d) Chloride shall be less than 800 ppm
- e) Cation exchange capacity shall be greater than 10 meq/100 g
- f) Organic matter shall be between 2 and 5%
- g) Carbon:Nitrogen ratio shall be between 12 and 40 (15 to 40 preferred)

Textural class fraction shall adhere to limits in Table 803-2.1, as determined by ASTM Method D422 or an approved alternative method:

**TABLE 803-2.3**

Textural Class (ASTM D422)	Size Range	Mass Fraction (percent)
Gravel	Larger than 2 mm	0 to 25 of total sample
Clay	Smaller than 0.005 mm	0 to 5 of non-gravel fraction

Test results shall show the following information:

- a) Date of testing
- b) Project name, contractor name, and source of materials and supplier name

## Appendix F: Biofiltration Standard and Checklist

- c) Copies of all testing reports including, at a minimum, analytical results sufficient to confirm compliance with all requirements listed in this section.

**803-2.4 Hydraulic Suitability.** BSM shall meet the have appropriate hydraulic properties for filtering stormwater. The BSM shall conform to the requirements herein to support plant growth. BSM which requires amending, shall be uniformly blended and tested in its blended state prior to testing and delivery.

**803-2.4.1 Testing.** The saturated hydraulic conductivity of the whole BSM shall be measured according to the method detailed in the measurement of hydraulic conductivity (USDA Handbook 60, method 34b), commonly available as part of standard agronomic soil evaluation, or ASTM D24234 Permeability of Granular Soils (at approximately 85% relative compaction Standard Proctor, ASTM D698). BSM shall conform to hydraulic criteria associated with the BMP design configuration that best applies to the facility where the BSM will be installed (Section 803-2.4.2 or 803-2.4.3).

**803-2.4.2 Systems with Unrestricted Underdrain System (i.e., media control).** For systems with underdrains that are not restricted, the BSM shall meet the minimum and maximum measured hydraulic conductivity found in Table 803-2.4 to ensure adequate flow rate through the BMP and longevity of the system but reduce excessive velocities through the media. In all cases, an upturned elbow system on the underdrain, measuring 9 to 12 inches above the invert of the underdrain, should be used to control velocities in the underdrain pipe and reduce potential for solid migration through the system.

**803-2.4.3 Systems with Restricted Underdrain System (i.e., outlet control).** For systems in which the flow rate of water through the media is controlled via an outlet control device (e.g., orifice or valve) affixed to the outlet of the underdrain system, the hydraulic conductivity of the media should meet the requirements in Table 803-2.4 and the outlet control device should control the flow rate to between 5 and 12 inches per hour. This configuration reduces the sensitivity of system performance to the hydraulic conductivity, compaction, and clogging of the material, reduces the likelihood of preferential flow through media, and allows more precise design and control of system flow rates. For these reasons, outlet control should be considered the preferred design option over unrestricted underdrain systems.

**803-2.4.4 Systems without Underdrains.** For systems without underdrains, the BSM shall have a hydraulic conductivity of at least 5 inches per hour, or at least 2 times higher than the design infiltration rate of the underlying soil, whichever is greater.

**Table 803-2.4.**

Underdrain System	Hydraulic Conductivity Requirements	
	Minimum (in/hr)	Maximum (in/hr)

## Appendix F: Biofiltration Standard and Checklist

Unrestricted (media control)	8	24
Restricted (outlet control) Preferred Design Option.	20	80

### 803-2.5 Chemical Suitability for Areas Draining to Impaired Receiving Waters.

**803-2.5.1 General.** The chemical suitability criteria listed in this section do not apply to systems without underdrains, unless groundwater is impaired or susceptible to nutrient contamination. Limits for a given parameter only apply if that parameter is associated with a water quality impairment, priority water quality condition, and/or TMDL in the receiving water. Limits may be waived at the discretion of the reviewing jurisdiction if it is determined by the jurisdiction that it is unreasonable to meet the specification using locally-available materials (available within 100 miles).

**803-2.5.2 Testing.** Potential for pollutant leaching shall be assessed using either the Saturated Media Extract Method (aka, Saturation Extract) that is commonly performed by agronomic laboratories or the Synthetic Precipitation Leaching Procedure (SPLP) (EPA SW-846, Method 1312). If the saturation extract method is used, samples may be rinsed with up to five pore volumes before collecting extract for analysis.

**803-2.5.3 BSM Limits in Areas Draining to Impaired Receiving Waters.** The limits in this section are in terms of the concentration of a parameter in water that has been contacted with the BSM.

**Table 803-2.5.3**

Applicable Pollutant(s)	Saturation Extract or SPLP Criteria
Phosphorus*	< 1 mg/L
Zinc	< 1 mg/L
Copper	< 0.04 mg/L
Lead	< 0.025 mg/L
Arsenic	< 0.02 mg/L
Cadmium	< 0.01 mg/L
Mercury	< 0.01 mg/L
Selenium	< 0.01 mg/L

**803-2.5.4 Alternative BSM for Reduced Phosphorus Leaching.** In areas with impaired receiving waters, including areas draining to Lake San Marcos and Lake Hodges, alternative BSM should be

## Appendix F: Biofiltration Standard and Checklist

considered, especially if receiving waters are phosphorus impaired. BSM with 20% compost may result in phosphorus leaching and soluble phosphorus test results in excess of the 1 mg/L limit presented in Table 803-2.5.3. Alternative organic amendments, such as coco coir pith and/or composted wood products, in place of compost should be considered in these areas. Sand and soil components with higher levels of iron and aluminum should also be considered to limit the solubility of phosphorus.

**803-5.5.5. Nitrogen Impaired Receiving Waters (including Lake San Marcos).** In areas with a downstream water quality impairment or TMDL for nitrogen, a combination of BSM composition and BMP design shall be used to reduce the potential for nitrate leaching from BMPs.

- BSM: The C:N ratio of BSM shall be between 15 and 40 to reduce the potential for nitrate leaching.
- BMP design: BMPs shall be designed to either enhance infiltration into underlying soils or with internal water storage to promote reduction of nitrogen:
  - If a BMP is installed with a liner, the BMP must include an internal saturated zone, consisting of at least an 18-inch thick layer of gravel, to enhance denitrification.
  - If a BMP does not include a liner, it must be installed with a retention zone below the underdrain discharge elevation, consisting of at least an 18-inch thick layer of gravel, to enhance infiltration into underlying soils.

### 803-3 SAND FOR BSM.

**803-3.1 General.** Sand used in BSM should preferably be washed prior to delivery. If sand is not washed it must still meet sieve analysis requirements in Table 1.

**803-3.2 Gradation Limits.** A sieve analysis shall be performed in accordance with California Test 202, ASTM D 422, or approved equivalent method to demonstrate compliance with the gradation limits shown in Table 803-3.2. Fines passing the No. 200 sieve shall be non-plastic.

TABLE 803-3.2

Sieve Size (ASTM D422)	Percentage Passing Sieve (by weight)	
	Minimum	Maximum
3/8 inch	100	100
#4	90	100
#8	70	100
#16	40	95
#30	15	70
#40	5	55
#100	0	15
#200	0	5

**803-4 TOPSOIL FOR BSM.**

**803-4.1 General.** Topsoil shall be free of hazardous materials and shall be consistent with a common definition of topsoil. Decomposed granite and derivatives of decomposed granite are not considered to be topsoil for the purpose of this specification.

**803-4.2 Textural Class.** Topsoil shall be classified as a sandy loam or a loamy sand according to the US Department of Agriculture soil classification system. In addition, a textural class analysis shall be performed in accordance with ASTM D422, or an approved alternative method to demonstrate compliance with the gradation limits in Table 803-4.2.

Table 803-4.2

Textural Class (ASTM D422)	Size Range	Mass Fraction (percent)
Gravel	Larger than 2 mm	0 to 25 of total sample
Clay	Smaller than 0.005 mm	0 to 15 of non-gravel fraction

**803-5 COMPOST FOR BSM.**

**803-5.1 General.** Compost shall be produced at a facility inspected and regulated by the local enforcement agency for CalRecycle. Compost should also preferably be certified by the U.S. Composting Council’s Seal of Testing Assurance Program (USCC STA) or an approved equivalent program. Compost shall not be produced from biosolids feedstock.



## Appendix F: Biofiltration Standard and Checklist

**803-5.1.1 Gradation Limits.** A sieve analysis shall be performed in accordance with ASTM D 422, or approved equivalent method to demonstrate compliance with the gradation limits show in Table 803-5.1.1.

**Table 803-5.1.1**

Sieve Size (ASTM D422)	Percent Passing Sieve (by weight)
1/2"	97 to 100
2 mm	40 to 90

**803-5.1.2 Material Content.** Organic Material Content shall be 35% to 100% by dry weight and moisture shall be 25% to 60% wet weight basis. Physical contaminants (manmade inert materials) shall not exceed 1% by dry weight.

**803-5.2 Compost Testing.** Compost shall meet the following requirements as demonstrated through standard agronomic testing methods:

- a) **Carbon to nitrogen (C:N) ratio.** C:N shall be between 15:1 and 40:1, preferably above 20:1 to reduce the potential for nitrogen leaching/washout.
- b) **pH.** pH shall be between 6.0 and 8.5.
- c) **Soluble Salt Concentration.** Soluble Salt Concentration shall be less than 10 dS/m. (Method TMECC 4.10-A, USDA and U.S. Composting Council).
- d) **Stability.** Carbon Dioxide evolution rate shall be less than 3.0 mg CO<sub>2</sub>-C per g compost organic matter (OM) per day or less than 6 mg CO<sub>2</sub>-C per g compost carbon per day, whichever unit is reported. (Method TMECC 5.08-B, USDA and U.S. Composting Council). Alternatively a Solvita rating of 5.5 or higher is acceptable.

**803-5.2.1 Pathogens and Pollutant Limits.** Select pathogens shall pass US EPA Class A standard, 40 CFR Section 503.32(a). Trace Metals shall pass US EPA Class A standard, 40 CFR Section 503.13, Table 1 for Ceiling Concentrations.

## 803-6 DELIVERY, STORAGE, HANDLING, AND PAYMENT

**803-6.1 General.** BSM shall be thoroughly mixed prior to delivery using mechanical mixing methods such as a drum mixer. The Contractor shall protect soils and mixes from absorbing excess water and from erosion at all times.

## Appendix F: Biofiltration Standard and Checklist

**803-6.1.1 Delivery.** The Contractor shall not deliver or place soils in wet or muddy conditions.

**803-6.1.2 Storage.** The Contractor shall not store materials unprotected during large rainfall events (>0.25 inches). If water is introduced into the material while it is stockpiled, the Contractor shall allow the material to drain to the acceptance of the reviewing jurisdiction before placement.

**803-6.1.3 Handling and Placement.** BSM shall be lightly compacted and placed in loose lifts approximately 12 inches (300 mm) to ensure reasonable settlement without excessive compaction. Compaction within the BSM area should not exceed 75 to 85% standard proctor within the BSM. Machinery shall not be used in the bioretention facility to place the BSM. A conveyor or spray system shall be used for media placement in large facilities. Low ground pressure equipment may be authorized for large facilities at the discretion of the reviewing jurisdiction. Placement methods and BSM quantities shall account for approximately 10% loss of volume due to settling. Planting methods and timing shall account for settling of media without exposing plant root systems.

**803-6.1.4 Hydraulic Suitability.** The reviewing jurisdiction may request up to three double ring infiltrometer tests (ASTM D3385) or approved alternative tests to confirm that the placed material meets applicable hydraulic suitability criteria. In the event that the infiltration rate of placed material does not meet applicable criteria, the reviewing jurisdiction may require replacement and/or de-compaction of materials.

### 803-6.2 Quality Control and Acceptance

**803-6.2.1 General.** Close adherence to the material quality controls herein are necessary in order to support healthy vegetation, minimize pollutant leaching, and assure sufficient permeability to infiltrate/filter runoff during the life of the facility. Amendments may be included to adjust agronomic properties. Acceptance of the material will be based on test results certified to be representative. Test results shall be conducted no more than 120 days prior to delivery of the blended BSM to the project site. For projects installing more than 100 cubic yards of BSM, batch-specific tests of the blended mix shall be provided to the reviewing jurisdiction for every 100 cubic yards of BSM along with a site plan showing the placement locations of each BSM batch within the facility.

**803-6.5 Measurement and Payment.** Quantities of mixed BSM will be measured as shown in the Bid. The volumetric quantity of mixed BSM to be paid for shall be the volume of BSM placed within the limits of the dimensions shown on the Plans.

## 803-7 AGGREGATE MATERIALS FOR BIORETENTION AND BIOFILTRATION DRAINAGE LAYERS

## Appendix F: Biofiltration Standard and Checklist

**803-7.1 General.** This section provides material specifications for drainage layers below BSM in bioretention BMPs. This consists of a two-layer filter course placed below the BSM and above an open-graded aggregate stone reservoir.

### 803-7.2 Rock and Sand Materials for Drainage Layers

**803-7.2.1 General.** All sand and stone products used in BSM drainage layers shall be clean and thoroughly washed.

**803-7.2.2 Filter Course.** Graded aggregate choker material is installed as a filter course to separate BSM from the drainage rock reservoir layer. The purpose of this layer is to limit migration of sand or other fines from the BSM. The filter course consists of two layers of choking material increasing in particle size. The top layer (closest to the BSM) of the filter course shall be constructed of thoroughly washed ASTM C33 Choker Sand as detailed in Table 200-1.5.5. The bottom layer of the filter course shall be constructed of thoroughly washed ASTM No. 8 aggregate material conforming to gradation limits contained in Table 200-1.2.1.

**803-7.2.3 Open-Graded Aggregate Stone.** Open-graded aggregate material is installed below filter course layers to provide additional storm water storage capacity and contain the underdrain pipe(s). This layer shall be constructed of thoroughly washed AASHTO No. 57 open graded aggregate material conforming to gradation limits contained in Table 200-1.2.1.

### 803-7.3 Layer Thicknesses and Construction.

**803-7.3.1 General.** Aggregate shall be deposited on underlying layers at a uniform quantity per linear foot (meter), which quantity will provide the required compacted thickness within the tolerances specified herein without resorting to spotting, picking up, or otherwise shifting the aggregate material.

**803-7.3.2 Filter Course Layers.** Each of the two filter course layers (top layer of ASTM C33 Choker Sand and bottom layer of ASTM No. 8) shall be installed to a thickness of 3 inches (75 mm). Both layers shall be spread in single layers. Marker stakes should be used to ensure uniform lift thickness.

**803-7.3.3 Aggregate Drainage and Storage Layer.** The thickness of the aggregate drainage and storage layer (AASHTO No. 57) will depend on site specific design and shall be detailed in contract documents.

**803-7.3.4 Spreading.** Drainage layers shall be as delivered as uniform mixtures and each layer shall be spread in one operation. Segregation within each aggregate layer shall be avoided and the layers shall be free from pockets of coarse or fine material.

**803-7.3.5 Compacting.** Filter course material and aggregate storage material shall be lightly compacted to approximately 80% standard proctor without the use of vibratory compaction.

## Appendix F: Biofiltration Standard and Checklist

**803-7.4 Measurement and Payment.** Quantities of graded aggregate choker material and open-graded aggregate storage material will be measured as shown in the Bid. The volumetric quantities of graded aggregate choker stone material and open-graded storage material shall be those placed within the limits of the dimensions shown on the Plans. The weight of material to be paid for will be determined by deducting (from the weight of material delivered to the Work) the weight of water in the material (at the time of weighing) in excess of 1% more than the optimum moisture content. No payment will be made for the weight of water deducted as provided in this subsection.

### 803-8 SUMMARY

Summary of BSM specification requirements for the City of San Diego and County of San Diego included in Table 803-8.

**Table 803-8**

Component	Requirement
BSM Material Composition	Sand: 60-80% by volume Topsoil: 0-20% by volume Compost: 20% by volume
Alternative Blends Acceptable?	Yes, but they must meet performance-based specifications.
Sand Type	Washed sand conforming to particle size distribution
Topsoil Type	Sandy loam or loamy sand with clay < 15% and gravel < 25%
Compost Type	From a CalRecycle permitted facility. Biosolids derived materials are not acceptable
BSM Permeability	8-24 inches/hour for BMPs without outlet control; 15-80 inches/hour for BMPs with outlet control; testing is required to demonstrate.
Agronomic Suitability Requirements	Limits for salts and potential toxins. C:N ration between 12 and 40.
Water Quality Related Limits?	Requirements related to specific pollutants when water quality of receiving waters is impaired for those pollutants.

Appendix

G

ESCONDIDO STORM WATER DESIGN MANUAL

# Guidance for Continuous Simulation and Hydromodification Management Sizing Factors

# Appendix G Guidance for Continuous Simulation and Hydromodification Management Sizing Factors

## G.1 Guidance for Continuous Simulation Hydrologic Modeling for Hydromodification Management Studies in San Diego County Region 9

### G.1.1 Introduction

Continuous simulation hydrologic modeling is used to demonstrate compliance with the performance standards for hydromodification management in San Diego. There are several available hydrologic models that can perform continuous simulation analyses. Each has different methods and parameters for determining the amount of rainfall that becomes runoff, and for representing the hydraulic operations of certain structural BMPs such as biofiltration with partial retention or biofiltration. This Appendix is intended to:

- Identify acceptable models for continuous simulation hydrologic analyses for hydromodification management;
- Provide guidance for selecting climatology input to the models;
- Provide standards for rainfall loss parameters to be used in the models;
- Provide standards for defining physical characteristics of LID components; and
- Provide guidance for demonstrating compliance with performance standards for hydromodification management.

This Appendix is not a user's manual for any of the acceptable models, nor a comprehensive manual for preparing a hydrologic model. This Appendix provides guidance for selecting model input parameters for the specific purpose of hydromodification management studies. The model preparer must be familiar with the user's manual for the selected software to determine how the parameters are entered to the model.

### G.1.2 Software for Continuous Simulation Hydrologic Modeling

The following software models may be used for hydromodification management studies in San Diego:

## Appendix G: Guidance for Continuous Simulation and Hydromodification Management Sizing Factors

- HSPF – Hydrologic Simulation Program-FORTRAN, distributed by USEPA, public domain.
- SDHM – San Diego Hydrology Model, distributed by Clear Creek Solutions, Inc. This is an HSPF-based model with a proprietary interface that has been customized for use in San Diego for hydromodification management studies.
- SWMM – Storm Water Management Model, distributed by USEPA, public domain.

Third-party and proprietary software, such as XPSWMM or PCSWMM, may be used for hydromodification management studies in San Diego, provided that:

- Input and output data from the software can interface with public domain software such as SWMM. In other words, input files from the third party software should have sufficient functionality to allow export to public domain software for independent validation.
- The software's hydromodification control processes are substantiated.

### G.1.3 Climatology Parameters

#### G.1.3.1 Rainfall

In all software applications for preparation of hydromodification management studies in San Diego, rainfall data must be selected from approved data sets that have been prepared for this purpose. As part of the development of the March 2011 Final HMP, long-term hourly rainfall records were prepared for public use. The rainfall record files are provided on the Project Clean Water website. The rainfall station map is provided in the March 2011 Final HMP and is included in this Appendix as Figure G.1-1.

# Appendix G: Guidance for Continuous Simulation and Hydromodification Management Sizing Factors

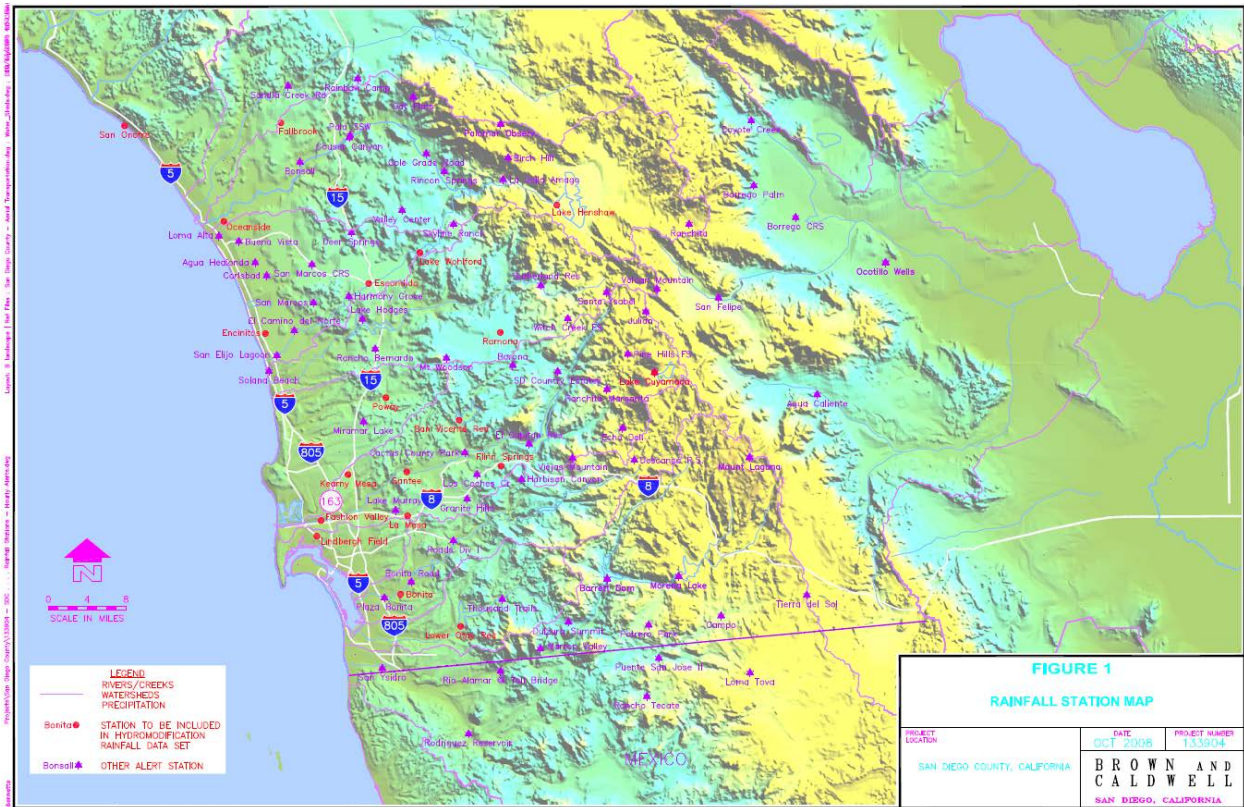

**Figure G.1-1: Rainfall Station Map**

Project applicants preparing continuous simulation models shall select the most appropriate rainfall data set from the rainfall record files provided on the Project Clean Water website. For a given project location, the following factors should be considered in the selection of the appropriate rainfall data set:

- In most cases, the rainfall data set in closest proximity to the project site will be the appropriate choice (refer to the rainfall station map).
- In some cases, the rainfall data set in closest proximity to the project site may not be the most applicable data set. Such a scenario could involve a data set with an elevation significantly different from the project site. In addition to a simple elevation comparison, the project proponent may also consult with the San Diego County’s average annual precipitation isopluvial map, which is provided in the San Diego County Hydrology Manual (2003). Review of this map could provide an initial estimate as to whether the project site is in a similar rainfall zone as compared to the rainfall stations. Generally, precipitation totals in San Diego County increase with increasing elevation.
- Where possible, rainfall data sets should be chosen so that the data set and the project location are both located in the same topographic zone (coastal, foothill, mountain) and major



## Appendix G: Guidance for Continuous Simulation and Hydromodification Management Sizing Factors

watershed unit (Upper San Luis Rey, Lower San Luis Rey, Upper San Diego River, Lower San Diego River, etc.).

For SDHM users, the approved rainfall data sets are pre-loaded into the software package. SDHM users may select the appropriate rainfall gauge within the SDHM program. HSPF or SWMM users shall download the appropriate rainfall record from the Project Clean Water website and load it into the software program.

Both the pre-development and post-project model simulation period shall encompass the entire rainfall record provided in the approved rainfall data set. Scaling the rainfall data is not permitted.

### G.1.3.2 Potential Evapotranspiration

Project applicants preparing continuous simulation models shall select a data set from the sources described below to represent potential evapotranspiration.

For HSPF users, this parameter may be entered as an hourly time series. The hourly time series that was used to develop the BMP Sizing Calculator parameters is provided on the project clean water website and may be used for hydromodification management studies in San Diego. For SDHM users, the hourly evaporation data set is pre-loaded into the program. HSPF users may download the evaporation record from the Project Clean Water website and load it into the software program.

For HSPF or SWMM users, this parameter may be entered as monthly values in inches per month or inches per day. Monthly values may be obtained from the California Irrigation Management Information System "Reference Evapotranspiration Zones" brochure and map (herein "CIMIS ETo Zone Map"), prepared by California Department of Water Resources, dated January 2012. The CIMIS ETo Zone Map is available from [www.cimis.gov](http://www.cimis.gov), and is provided in this Appendix as Figure G.1-2. Determine the appropriate reference evapotranspiration zone for the project from the CIMIS ETo Zone Map. The monthly average reference evapotranspiration values are provided below in Table G.1-1.

Appendix G: Guidance for Continuous Simulation and Hydromodification Management Sizing Factors

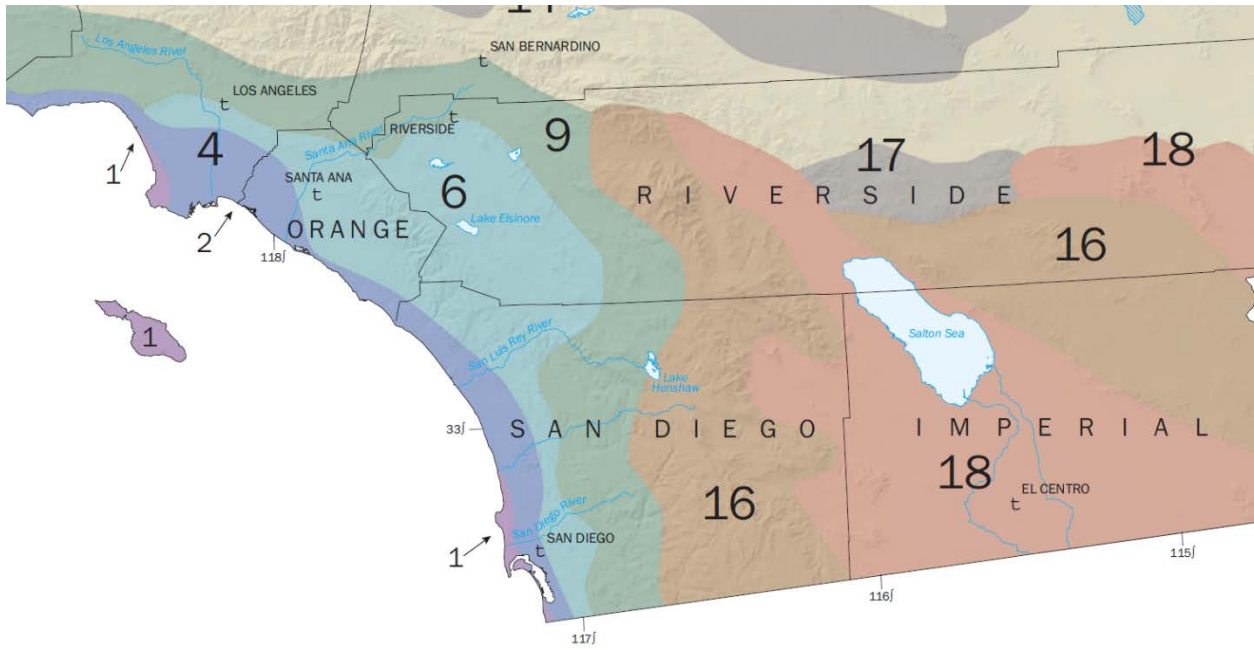

Figure G.1-2: California Irrigation Management Information System "Reference Evapotranspiration Zones"

**Appendix G: Guidance for Continuous Simulation and Hydromodification Management Sizing Factors**

**Table G.1-1: Monthly Average Reference Evapotranspiration by ETo Zone  
(inches/month and inches/day) for use in SWMM Models for Hydromodification Management Studies in San Diego County  
CIMIS Zones 1, 4, 6, 9, and 16 (See CIMIS ETo Zone Map)**

	January	February	March	April	May	June	July	August	September	October	November	December
Zone	in/month	in/month	in/month	in/month	in/month	in/month	in/month	in/month	in/month	in/month	in/month	in/month
1	0.93	1.4	2.48	3.3	4.03	4.5	4.65	4.03	3.3	2.48	1.2	0.62
4	1.86	2.24	3.41	4.5	5.27	5.7	5.89	5.58	4.5	3.41	2.4	1.86
6	1.86	2.24	3.41	4.8	5.58	6.3	6.51	6.2	4.8	3.72	2.4	1.86
9	2.17	2.8	4.03	5.1	5.89	6.6	7.44	6.82	5.7	4.03	2.7	1.86
16	1.55	2.52	4.03	5.7	7.75	8.7	9.3	8.37	6.3	4.34	2.4	1.55
	January	February	March	April	May	June	July	August	September	October	November	December
Days	31	28	31	30	31	30	31	31	30	31	30	31
Zone	in/day	in/day	in/day	in/day	in/day	in/day	in/day	in/day	in/day	in/day	in/day	in/day
1	0.030	0.050	0.080	0.110	0.130	0.150	0.150	0.130	0.110	0.080	0.040	0.020
4	0.060	0.080	0.110	0.150	0.170	0.190	0.190	0.180	0.150	0.110	0.080	0.060
6	0.060	0.080	0.110	0.160	0.180	0.210	0.210	0.200	0.160	0.120	0.080	0.060
9	0.070	0.100	0.130	0.170	0.190	0.220	0.240	0.220	0.190	0.130	0.090	0.060
16	0.050	0.090	0.130	0.190	0.250	0.290	0.300	0.270	0.210	0.140	0.080	0.050

#### G.1.4 Land Characteristics and Loss Parameters

In all software applications for preparation of hydromodification management studies in San Diego, rainfall loss parameters must be consistent with this Appendix unless the preparer can provide documentation to substantiate use of other parameters, subject to local jurisdiction approval. HSPF and SWMM use different processes and different sets of parameters. SDHM is based on HSPF, therefore parameters for SDHM and HSPF are presented together in Section G.1.4.1. Parameters that have been pre-loaded into SDHM may be used for other HSPF hydromodification management studies outside of SDHM. Parameters for SWMM are presented separately in Section G.1.4.2.

##### **G.1.4.1 Rainfall Loss Parameters for HSPF and SDHM**

Rainfall losses in HSPF are characterized by PERLND/PWATER parameters and IMPLND parameters, which describe processes occurring when rainfall lands on pervious lands and impervious lands, respectively. "BASINS Technical Notice 6, Estimating Hydrology and Hydraulic Parameters for HSPF," prepared by the USEPA, dated July 2000, provides details regarding these parameters and summary tables of possible ranges of these parameters. Table G.1-2, excerpted from the above-mentioned document, presents the ranges of these parameters.

For HSPF studies for hydromodification management in San Diego, PERLND/PWATER parameters and IMPLND parameters shall fall within the "possible" range provided in EPA Technical Note 6. To select specific parameters, HSPF users may use the parameters established for development of the San Diego BMP Sizing Calculator, and/or the parameters that have been established for SDHM. Parameters for the San Diego BMP Sizing Calculator and SDHM are based on research conducted specifically for HSPF modeling in San Diego.

Documentation of parameters selected for the San Diego BMP Sizing Calculator is presented in the document titled, San Diego BMP Sizing Calculator Methodology, prepared by Brown and Caldwell, dated January 2012 (herein "BMP Sizing Calculator Methodology"). The PERLND/PWATER parameters selected for development of the San Diego BMP Sizing Calculator represent a single composite pervious land cover that is representative of most pre-development conditions for sites that would commonly be managed by the BMP Sizing Calculator. The parameters shown below in Table G.1-3 are excerpted from the BMP Sizing Calculator Methodology.

## Appendix G: Guidance for Continuous Simulation and Hydromodification Management Sizing Factors

**Table G.1-2: HSPF PERLND/PWATER and IMPLND Parameters from EPA Technical Note 6**

Name	Definition	Units	Range of Values				Function of ...	Comment
			Typical		Possible			
			Min	Max	Min	Max		
<b>PWAT – PARM2</b>								
FOREST	Fraction forest cover	none	0.0	0.50	0.0	0.95	Forest cover	Only impact when SNOW is active
LZSN	Lower Zone Nominal Soil Moisture Storage	inches	3.0	8.0	2.0	15.0	Soils, climate	<b>Calibration</b>
INFILT	Index to Infiltration Capacity	in/hr	0.01	0.25	0.001	0.50	Soils, land use	<b>Calibration</b> , divides surface and subsurface flow
LSUR	Length of overland flow	feet	200	500	100	700	Topography	Estimate from high resolution topo maps or GIS
SLSUR	Slope of overland flow plane	ft/ft	0.01	0.15	0.001	0.30	Topography	Estimate from high resolution topo maps or GIS
KVARY	Variable groundwater recession	1/inches	0.0	3.0	0.0	5.0	Baseflow recession variation	Used when recession rate varies with GW levels
AGWRC	Base groundwater recession	none	0.92	0.99	0.85	0.999	Baseflow recession	<b>Calibration</b>
<b>PWAT – PARM3</b>								
PETMAX	Temp below which ET is reduced	deg. F	35.0	45.0	32.0	48.0	Climate, vegetation	Reduces ET near freezing, when SNOW is active
PETMIN	Temp below which ET is set to zero	deg. F	30.0	35.0	30.0	40.0	Climate, vegetation	Reduces ET near freezing, when SNOW is active
INFEXP	Exponent in infiltration equation	none	2.0	2.0	1.0	3.0	Soils variability	Usually default to 2.0
INFILD	Ratio of max/mean infiltration capacities	none	2.0	2.0	1.0	3.0	Soils variability	Usually default to 2.0
DEEPPFR	Fraction of GW inflow to deep recharge	none	0.0	0.20	0.0	0.50	Geology, GW recharge	Accounts for subsurface losses
BASETP	Fraction of remaining ET from baseflow	none	0.0	0.05	0.0	0.20	Riparian vegetation	Direct ET from riparian vegetation
AGWETP	Fraction of remaining ET from active GW	none	0.0	0.05	0.0	0.20	Marsh/wetlands extent	Direct ET from shallow GW
<b>PWAT – PARM4</b>								
CEPSC	Interception storage capacity	inches	0.03	0.20	0.01	0.40	Vegetation type/density, land use	Monthly values usually used
UZSN	Upper zone nominal soil moisture storage	inches	0.10	1.0	0.05	2.0	Surface soil conditions, land use	Accounts for near surface retention
NSUR	Manning's n (roughness) for overland flow	none	0.15	0.35	0.05	0.50	Surface conditions, residue, etc.	Monthly values often used for croplands
INTFW	Interflow inflow parameter	none	1.0	3.0	1.0	10.0	Soils, topography, land use	<b>Calibration</b> , based on hydrograph separation
IRC	Interflow recession parameter	none	0.5	0.70	0.30	0.85	Soils, topography, land use	Often start with a value of 0.7, and then adjust
LZETP	Lower zone ET parameter	none	0.2	0.70	0.1	0.9	Vegetation type/density, root depth	<b>Calibration</b>
<b>IWAT – PARM2</b>								
LSUR	Length of overland flow	feet	50	150	50	250	Topography, drainage system	Estimate from maps, GIS, or field survey
SLSUR	Slope of overland flow plane	ft/ft	0.01	0.05	0.001	0.15	Topography, drainage	Estimate from maps, GIS, or field survey
NSUR	Manning's n (roughness) for overland flow	none	0.03	0.10	0.01	0.15	Impervious surface conditions	Typical range is 0.05 to 0.10 for roads/parking lots
RETSC	Retention storage capacity	inches	0.03	0.10	0.01	0.30	Impervious surface conditions	Typical range is 0.03 to 0.10 for roads/parking lots
<b>IWAT – PARM3 (PETMAX and PETMIN, same values as shown for PWAT – PARM3)</b>								

## Appendix G: Guidance for Continuous Simulation and Hydromodification Management Sizing Factors

This page was left intentionally blank.

**Appendix G: Guidance for Continuous Simulation and Hydromodification Management Sizing Factors**

**Table G.1-3: HSPF PERLND/PWATER Parameters from BMP Sizing Calculator Methodology**

	Slope	Hydrologic Soil Group A			Hydrologic Soil Group B			Hydrologic Soil Group C			Hydrologic Soil Group D		
		5%	10%	15%	5%	10%	15%	5%	10%	15%	5%	10%	15%
PWAT_PAR M2	Units												
FOREST	None	0	0	0	0	0	0	0	0	0	0	0	0
LZSN	inches	5.2	4.8	4.5	5.0	4.7	4.4	4.8	4.5	4.2	4.8	4.5	4.2
INFILT	in/hr	0.090	0.070	0.045	0.070	0.055	0.040	0.050	0.040	0.032	0.040	0.030	0.020
LSUR	Feet	200	200	200	200	200	200	200	200	200	200	200	200
SLSUR	ft/ft	0.05	0.1	0.15	0.05	0.1	0.15	0.05	0.1	0.15	0.05	0.1	0.15
KVARY	1/inches	3	3	3	3	3	3	3	3	3	3	3	3
AGWRC	None	0.92	0.92	0.92	0.92	0.92	0.92	0.92	0.92	0.92	0.92	0.92	0.92
PWAT_PAR M3													
PETMAX (F)	F	35	35	35	35	35	35	35	35	35	35	35	35
PETMIN (F)	F	30	30	30	30	30	30	30	30	30	30	30	30
INFEXP	None	2	2	2	2	2	2	2	2	2	2	2	2
INFILD	None	2	2	2	2	2	2	2	2	2	2	2	2
DEEPR	None	0.4	0.4	0.4	0.4	0.4	0.4	0.4	0.4	0.4	0.4	0.4	0.4
BASETP	None	0.05	0.05	0.05	0.05	0.05	0.05	0.05	0.05	0.05	0.05	0.05	0.05
AGEWTP	None	0.05	0.05	0.05	0.05	0.05	0.05	0.05	0.05	0.05	0.05	0.05	0.05
PWAT_PAR M4													
CEPSC	inches	0.08	0.08	0.08	0.08	0.08	0.08	0.08	0.08	0.08	0.08	0.08	0.08
UZSN	inches	0.6	0.6	0.6	0.6	0.6	0.6	0.6	0.6	0.6	0.6	0.6	0.6
NSUR	None	0.2	0.2	0.2	0.2	0.2	0.2	0.2	0.2	0.2	0.2	0.2	0.2
INTFW	None	1.5	1.5	1.5	1.5	1.5	1.5	1.5	1.5	1.5	1.5	1.5	1.5
IRC	None	0.7	0.7	0.7	0.7	0.7	0.7	0.7	0.7	0.7	0.7	0.7	0.7
LZETP	None	0.5	0.5	0.5	0.5	0.5	0.5	0.5	0.5	0.5	0.5	0.5	0.5

## **Appendix G: Guidance for Continuous Simulation and Hydromodification Management Sizing Factors**

Parameters within SDHM are documented in "San Diego Hydrology Model User Manual," prepared by Clear Creek Solutions, Inc. (as of the development of the Manual, the current version of the SDHM User Manual is dated January 2012). Parameters established for SDHM represent "grass" (non-turf grasslands), "dirt," "gravel," and "urban" cover. The documented PERLND and IMPLND parameters for the various land covers and soil types have been pre-loaded into SDHM. SDHM users shall use the parameters that have been pre-loaded into the program without modification unless the preparer can provide documentation to substantiate use of other parameters.

### **G.1.4.2 Rainfall Loss Parameters for SWMM**

In SWMM, rainfall loss parameters (parameters that describe processes occurring when rainfall lands on pervious lands and impervious lands) are entered in the "subcatchment" module. In addition to specifying parameters, the SWMM user must also select an infiltration model.

The SWMM Manual provides details regarding the subcatchment parameters and summary tables of possible ranges of these parameters. For SWMM studies for hydromodification management in San Diego, subcatchment parameters shall fall within the range provided in the SWMM Manual. Some of the parameters depend on the selection of the infiltration model. For consistency across the San Diego region, SWMM users shall use the Green-Ampt infiltration model for hydromodification management studies. Table G.1-4 presents SWMM subcatchment parameters for use in hydromodification management studies in the San Diego region.



**Appendix G: Guidance for Continuous Simulation and Hydromodification Management Sizing Factors**

**Table G.1-4: Subcatchment Parameters for SWMM Studies for Hydromodification Management in San Diego**

SWMM Parameter Name	Unit	Range	Use in San Diego
Name X-Coordinate Y-Coordinate Description Tag Rain Gage Outlet	N/A	N/A – project-specific	Project-specific
Area	acres (ac)	Project-specific	Project-specific
Width	feet (ft)	Project-specific	Project-specific
% Slope	percent (%)	Project-specific	Project-specific
% Imperv	percent (%)	Project-specific	Project-specific
N-imperv	--	0.011 – 0.024 presented in Table A.6 of SWMM Manual	default use 0.012 for smooth concrete, otherwise provide documentation of other surface consistent with Table A.6 of SWMM Manual
N-Perv	--	0.05 – 0.80 presented in Table A.6 of SWMM Manual	default use 0.15 for short prairie grass, otherwise provide documentation of other surface consistent with Table A.6 of SWMM Manual
Dstore-Imperv	inches	0.05 – 0.10 inches presented in Table A.5 of SWMM Manual	0.05
Dstore-Perv	inches	0.10 – 0.30 inches presented in Table A.5 of SWMM Manual	0.10
%ZeroImperv	percent (%)	0% – 100%	25%
Subarea routing	--	OUTLET IMPERVIOUS PERVIOUS	Project-specific, typically OUTLET
Percent Routed	%	0% – 100%	Project-specific, typically 100%

**Appendix G: Guidance for Continuous Simulation and Hydromodification Management Sizing Factors**

SWMM Parameter Name	Unit	Range	Use in San Diego
Infiltration	Method	HORTON GREEN_AMPT CURVE_NUMBER	GREEN_AMPT
Suction Head (Green-Ampt)	Inches	1.93 – 12.60 presented in Table A.2 of SWMM Manual	Hydrologic Soil Group A: 1.5 Hydrologic Soil Group B: 3.0 Hydrologic Soil Group C: 6.0 Hydrologic Soil Group D: 9.0
Conductivity (Green-Ampt)	Inches per hour	0.01 – 4.74 presented in Table A.2 of SWMM Manual by soil texture class 0.00 – $\geq 0.45$ presented in Table A.3 of SWMM Manual by hydrologic soil group	Hydrologic Soil Group A: 0.3 Hydrologic Soil Group B: 0.2 Hydrologic Soil Group C: 0.1 Hydrologic Soil Group D: 0.025  Note: reduce conductivity by 25% in the post-project condition when native soils will be compacted. Conductivity may also be reduced by 25% in the pre-development condition model for redevelopment areas that are currently concrete or asphalt but must be modeled according to their underlying soil characteristics. For fill soils in post-project condition, see Section G.1.4.3.
Initial Deficit (Green-Ampt)		The difference between soil porosity and initial moisture content. Based on the values provided in Table A.2 of SWMM Manual, the range for completely dry soil would be 0.097 to 0.375	Hydrologic Soil Group A: 0.33 Hydrologic Soil Group B: 0.32 Hydrologic Soil Group C: 0.31 Hydrologic Soil Group D: 0.30  Note: in long-term continuous simulation, this value is not important as the soil will reach equilibrium after a few storm events regardless of the initial moisture content specified.
Groundwater	yes/no	yes/no	NO

**Appendix G: Guidance for Continuous Simulation and Hydromodification Management Sizing Factors**

SWMM Parameter Name	Unit	Range	Use in San Diego
LID Controls			Project Specific
Snow Pack Land Uses Initial Buildup Curb Length			Not applicable to hydromodification management studies

A schematic of the basic SWMM setup for hydromodification management studies is shown below, with the LID module is shown as a feature within the hydrology computational block. Surface water hydrology is distinguished from groundwater, however the groundwater module is not typically used in hydromodification management studies.

The rainfall and climatology input time series data are used to generate surface runoff which in turn is hydraulically routed through the collection system and storage/treatment facilities. The figure includes the following terms in the water balance equation:

- P = Precipitation
- E/T = Evaporation / Transpiration
- I/S = Infiltration / Seepage
- Q = Runoff

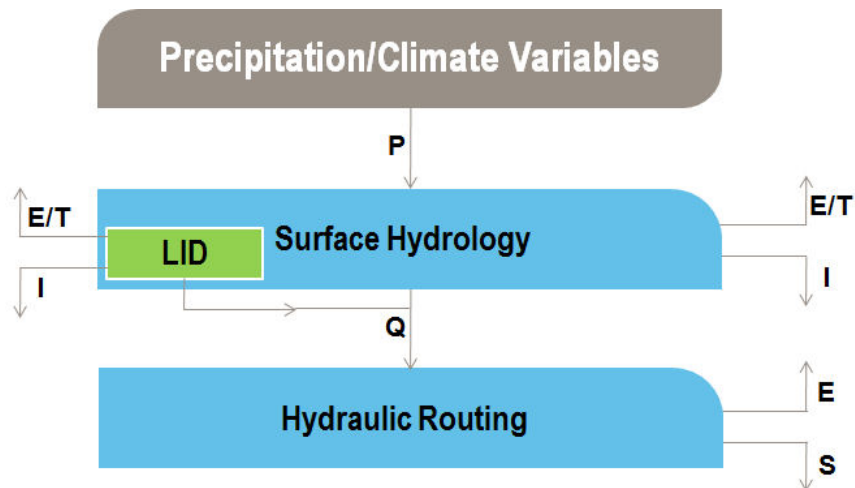

Evapotranspiration was previously addressed above; the remainder of this section discusses the other

## Appendix G: Guidance for Continuous Simulation and Hydromodification Management Sizing Factors

hydrologic losses and parameters.

### Soil and Infiltration Parameters

Of the infiltration options available in SWMM, the Green-Ampt equation can best handle variable water content conditions in the shallow soil layers beneath the ground surface, which is critical for long-term continuous simulation of surface water hydrology. The Green-Ampt parameters suggested in Table G.1-4 are referenced according to hydrologic soil group. Green-Ampt parameters can also be determined by relating infiltration parameters to soil texture properties, as identified by in-situ geotechnical analysis results or published County soil survey information. Infiltration parameters include:

- Capillary Tension (Suction Head): a measure of how tightly water is held within the soil pore space;
- Saturated Hydraulic Conductivity: a measure of how quickly the water can be drained vertically; and
- Initial Moisture Deficit: a measure of the initial soilwater deficit, also known as porosity (i.e., the volumetric fraction of water within the soil pore space under initially dry conditions).

Note that when SWMM is used without the Groundwater module, there is no distinction between the upper and lower zone soil moisture storage as in HSPF/SDHM. The LID module does however distinguish several layers/zones within each facility, and these are described below.

### Overland Flow Parameters

Overland flow parameters describe the slope and length characteristics of shallow surface runoff. These are determined by identifying representative overland flow paths for each subcatchment using available digital topographic data for pre-development conditions and the proposed grading plan for post-project conditions. Overland flow path lengths and slopes are measured directly from the available information. Generally, overland flow paths should be less than 1,000 feet in length, otherwise channelized flow is likely present and should be modeled hydraulically. Overland flow path widths are determined based on the subcatchment area divided by the corresponding flow path length for each subcatchment.

Although Surface Storage is not depicted in SWMM schematic, it is a component of the water balance equation and includes excess runoff that is held in both hydrologic depression storage and hydraulic storage units.

## LID Module

There are two approaches for representing LID facilities in SWMM:

- **Modeling Approach No. 1:** Place LID controls within the appropriate subcatchment and then adjust parameters accordingly to reflect untreated areas within the parent subcatchment; and
- **Modeling Approach No. 2:** Create a new subcatchment for each LID control, allowing “run-on” from the treated portion of the parent subcatchment.

Modeling Approach No.1 schematic is presented below. As described above, a portion of the impervious subarea from a given subcatchment can be routed onto the pervious area for infiltration (see arrow denoting subarea routing fraction). When the LID module of SWMM is used, the portion of the impervious area that is captured and treated by an LID facility is specified (see arrow denoting LID area fraction). The remaining impervious area, if any, is routed directly to the outlet.

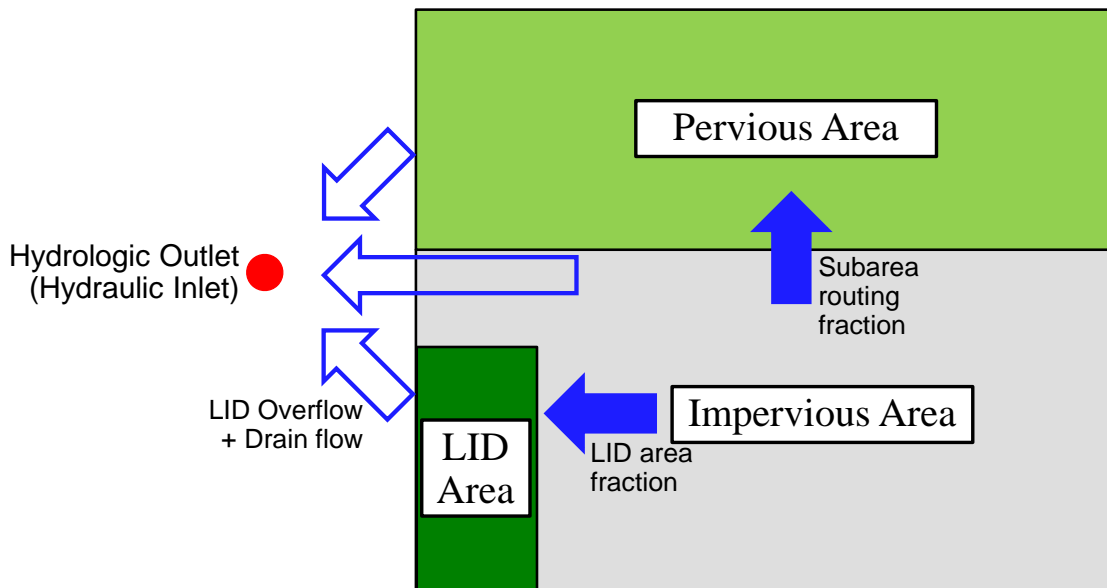

### Modeling Approach No. 1 (LID within Parent Subcatchment)

The first approach is the easiest of the two for representing LID facilities in SWMM, as it allows a mix of controls to be placed within an existing subcatchment and each facility can capture and treat a different portion of the runoff generated from the parent subcatchment (i.e., outside of the LID footprint). A drawback of this approach is that it will not appropriately represent LID facilities in series (i.e., where the outflow from one LID control becomes the inflow to another LID control). No adjustments to the parent subcatchment hydrology parameters are needed if the cumulative LID area

## Appendix G: Guidance for Continuous Simulation and Hydromodification Management Sizing Factors

is small in comparison to the subcatchment area. However when the cumulative LID area is significant (e.g., greater than 10% of the subcatchment), at a minimum, the imperviousness and overland flow width values will need to be adjusted to compensate for the parent subcatchment area that was replaced with the cumulative LID footprint area.

Modeling Approach No.2 schematic is presented below. In this approach the LID facility is assigned to a new subcatchment and runoff from upstream subcatchments can be directed to this new subcatchment (i.e., “run-on”). In this way, LID controls can be modeled in series. Adjustments to the imperviousness and overland flow width values in the parent subcatchment will need to be made. For typical development or redevelopment sites that are evaluated in hydromodification management studies, LID capture areas often comprise a large portion of the parent subcatchments, and therefore this is the preferred approach.

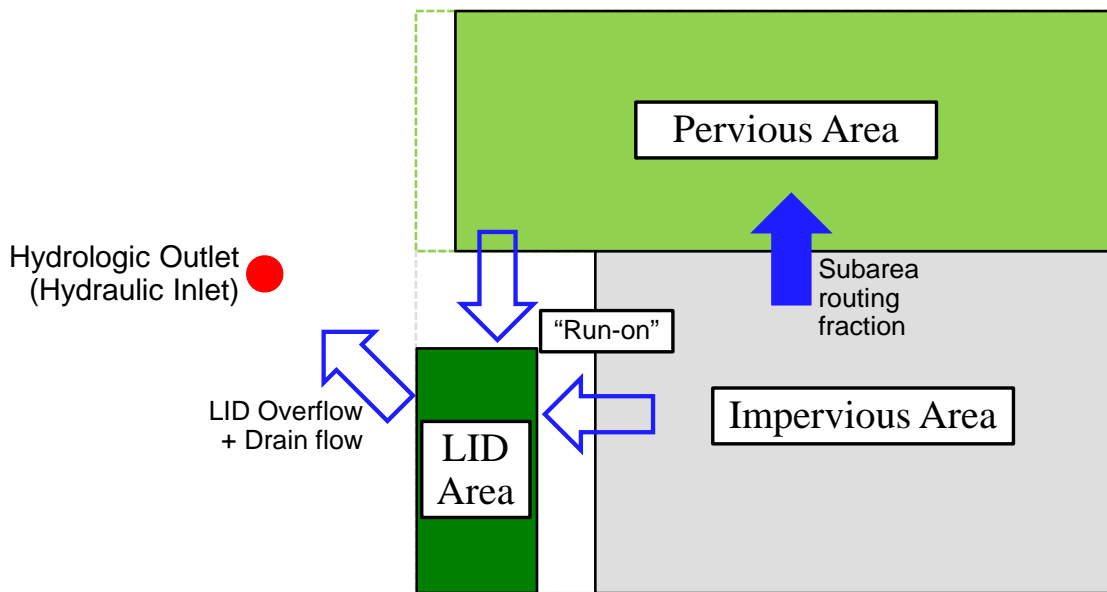

**Modeling Approach No. 2 (LID in New Subcatchment)**

More details on the use and application of LID controls are provided in the SWMM Manual and program help file. Suggested parameter values for use with hydromodification management studies in San Diego are provided in Appendix G.1.5.

### **G.1.4.3 Pervious Area Rainfall Loss Parameters in Post-Project Condition (HSPF, SDHM, and SWMM)**

The following guidance applies to HSPF, SDHM, and SWMM. When modeling pervious areas in the post-project condition, fill soils shall be modeled as hydrologic soil group Type D soils, or the project applicant may provide an actual expected infiltration rate for the fill soil based on testing (must be

## Appendix G: Guidance for Continuous Simulation and Hydromodification Management Sizing Factors

approved by the City Engineer for use in the model). Where landscaped areas on fill soils will be re-tilled and/or amended in the post-project condition, the landscaped areas may be modeled as Type C soils. Areas to be re-tilled and/or amended in the post-project condition must be shown on the project plans. For undisturbed pervious areas (i.e., native soils, no fill), use the actual hydrologic soil group, the same as in the pre-development condition.

### G.1.5 Modeling Structural BMPs (Ponds and Lid Features)

There are many ways to model structural BMPs. There are standard modules for several pond or LID elements included in SDHM and SWMM. Users may also set up project-specific stage-storage-discharge relationships representing structural BMPs. Regardless of the modeling method, certain characteristics of the structural BMP, including infiltration of water from the bottom of the structural BMP into native soils, porosity of bioretention soils and/or gravel sublayers, and other program-specific parameters must be consistent with those presented below, unless the preparer can provide documentation to substantiate use of other parameters, subject to local jurisdiction approval. The geometry of structural BMPs is project-specific and shall match the project plans.

#### G.1.5.1 Infiltration into Native Soils Below Structural BMPs

Infiltration into native soils below structural BMPs may be modeled as a constant outflow rate equal to the project site-specific design infiltration rate (Worksheet D.5-1) multiplied by the area of the infiltrating surface (and converted to cubic feet per second). This infiltration rate is not the same as an infiltration parameter used in the calculation of rainfall losses, such as the HSPF INFILT parameter or the Green-Ampt conductivity parameter in the SWMM subcatchment module. It must be site-specific and must be determined based on the methods presented in Appendix D of this manual.

For preliminary analysis when site-specific geotechnical investigation has not been completed, project applicants proposing infiltration into native soils as part of the structural BMP design shall prepare a sensitivity analysis to determine a potential range for the structural BMP size based on a range of potential infiltration rates. As shown in Appendices C and D of this manual, many factors influence the ability to infiltrate storm water. Therefore even when soils types A and B are present, which are generally expected to infiltrate storm water, the possibility that a very low infiltration rate could be determined at design level must be considered. The range of potential infiltration rates for preliminary analysis is shown below in Table G.1-5.

**Appendix G: Guidance for Continuous Simulation and Hydromodification Management Sizing Factors**

**Table G.1-5: Range of Potential Infiltration Rates to be Studied for Sensitivity Analysis when Native Infiltration is Proposed but Site-Specific Geotechnical Investigation has not been Completed**

Hydrologic Soil Group at Location of Proposed Structural BMP	Low Infiltration Rate for Preliminary Study (inches/hour)	High Infiltration Rate for Preliminary Study (inches/hour)
A	0.02	2.4
B	0.02	0.52
C	0	0.08
D	0	0.02

The infiltration rates shown above are for preliminary investigation only. Final design of a structural BMP must be based on the project site-specific design infiltration rate (Worksheet D.5-1).

**G.1.5.2 Structural BMPs That Do Not Include Sub-Layers (Ponds)**

To model a pond, basin, or other depressed area that does not include processing runoff through sublayers of amended soil and/or gravel, create a stage storage discharge relationship for the pond, and supply the information to the model according to the program requirements. For HSPF users, the stage-storage-discharge relationship is provided in FTABLES. SDHM users may use the TRAPEZOIDAL POND element for a trapezoidal pond or IRREGULAR POND element to request the program to create the stage-storage-discharge relationship, use the SSD TABLE element to supply a user-created stage-storage-discharge relationship, or use other available modules such as TANK or VAULT. For SWMM users, the stage-storage relationship is supplied in the storage unit module, and the stage-discharge relationship may be represented by various other modules such as the orifice, weir, or outlet modules. Stage-storage and stage-discharge curves for structural BMPs must be fully documented in the project-specific HMP report and must be consistent with the structural BMP(s) shown on project plans.

For user-created stage-discharge relationships, refer to local drainage manual criteria for equations representing hydraulic behavior of outlet structures. Users relying on the software to develop the stage-discharge relationship may use the equations built into the program. This manual does not recommend that all program modules calculating stage-discharge relationships must be uniform because the flows to be controlled for hydromodification management are low flows, calculated differently from the single-storm event peak flows studied for flood control purposes, and hydromodification management performance standards do not represent any performance standard for flood control drainage design. Note that for design of emergency outlet structures, and any calculations related to single-storm event routing for flood control drainage design, stage-discharge calculations must be consistent with the local drainage design requirements. This may require separate calculations for stage-discharge relationship pursuant to local manuals. The HMP flow rates shall not be used for flood control calculations.



**G.1.5.3 Structural BMPs That Include Sub-Layers (Bioretention and Other LID)**

**G.1.5.3.1 Characteristics of Bioretention Soil Media**

The bioretention soil media used in bioretention, biofiltration with partial retention, and biofiltration structural BMPs is a sandy loam. The following parameters presented in Table G.1-6 are characteristics of a sandy loam for use in continuous simulation models.

**Table G.1-6: Characteristics of Sandy Loam to Represent Bioretention Soil Media in Continuous Simulation for Hydromodification Management Studies in San Diego**

Soil Texture	Porosity	Field Capacity	Wilting Point	Conductivity	Suction Head
Sandy Loam	0.4	0.2	0.1	5 inches/hour	1.5 inches

- Porosity is the volume of pore space (voids) relative to the total volume of soil (as a fraction).
- Field Capacity is the volume of pore water relative to total volume after the soil has been allowed to drain fully (as a fraction). Below this level, vertical drainage of water through the soil layer does not occur.
- Wilting point is the volume of pore water relative to total volume for a well dried soil where only bound water remains (as a fraction). The moisture content of the soil cannot fall below this limit.
- Conductivity is the hydraulic conductivity for the fully saturated soil (in/hr or mm/hr).
- Suction head is the average value of soil capillary suction along the wetting front (inches or mm).

Figures G.1-3 and G.1-4, from <http://www.stevenswater.com/articles/irrigationscheduling.aspx>, illustrate unsaturated soil and soil saturation, field capacity, and wilting point.

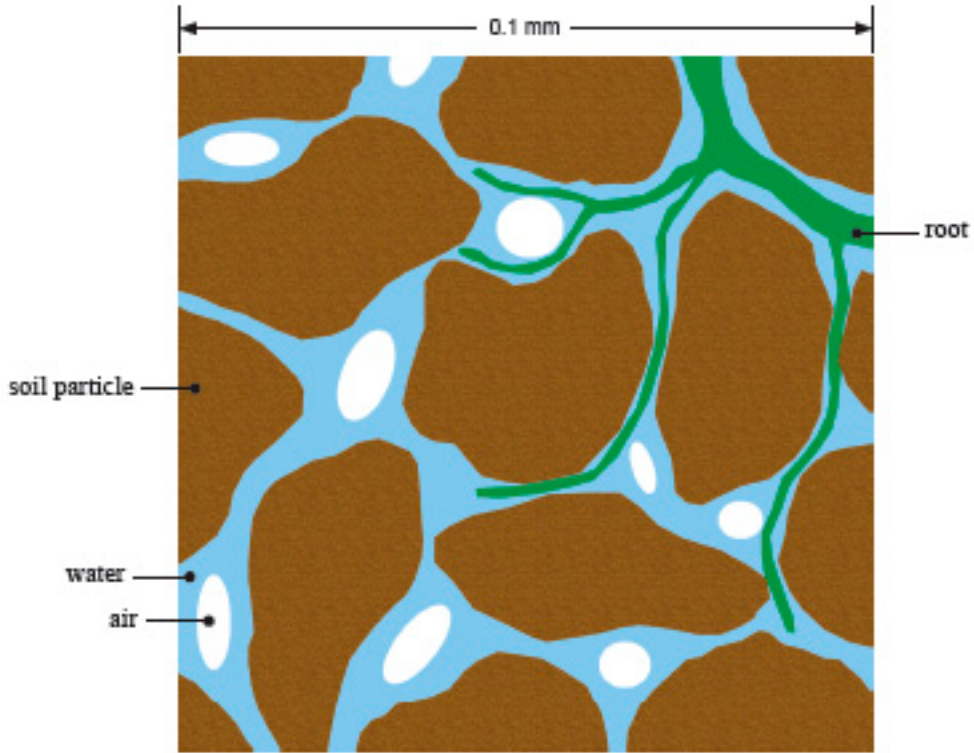

Figure G.1-3: Unsaturated Soil Composition

Unsaturated soil is composed of solid particles, organic material and pores. The pore space will contain air and water.

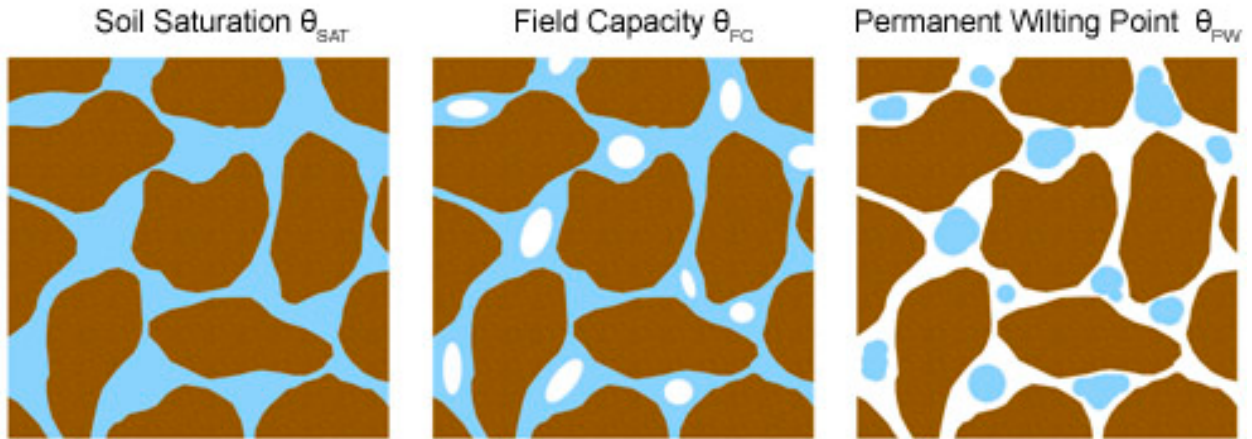

Figure G.1-4: Soil saturation, field capacity, and wilting point

## Appendix G: Guidance for Continuous Simulation and Hydromodification Management Sizing Factors

### G.1.5.3.2 Characteristics of Gravel

For the purpose of hydromodification management studies, it may be assumed that water moves freely through gravel, not limited by hydraulic properties of the gravel. For the purpose of calculating available volume, use porosity of 0.4, or void ratio of 0.67. Porosity is equal to void ratio divided by  $(1 + \text{void ratio})$ .

### G.1.5.3.3 Additional Guidance for SDHM Users

The module titled "bioretention/rain garden element" may be used to represent bioretention or biofiltration BMPs. SDHM users using the available "bioretention/rain garden element" shall customize the soil media characteristics to use the parameters from Table G.1-6 above, and select "gravel" for gravel sublayers. All other input variables are project-specific. "Native infiltration" refers to infiltration from the bottom of the structural BMP into the native soil. This variable is project-specific, see Section G.1.5.1.

### G.1.5.3.4 Additional Guidance for SWMM Users

The latest version of SWMM (version 5.1.012) includes the following eight types of LID controls:

- Bio-Retention Cell: surface storage facility with vegetation in an bioretention soil mixture placed above a gravel drainage bed.
- Rain Garden: same setup as bio-retention cell, but without an underlying gravel bed.
- Green Roof: bio-retention cell with shallow surface storage and soil layers, underlain by a drainage mat that conveys excess percolated rainfall to the regular roof drainage system.
- Infiltration Trench: drainage swale or narrow storage basin filled with gravel or other porous media designed to capture and infiltrate runoff to the native soil below.
- Permeable Pavement: continuous pavement systems with porous concrete, asphalt mix, or paver blocks above a sand or gravel drainage bed with gravel storage layer below.
- Rain Barrel: container (cistern) to collect roof runoff for later use (e.g., landscape irrigation) or release.
- Rooftop Disconnection: to simulate redirection of downspout discharge onto pervious landscaped areas and lawns instead of directly into storm drains.
- Vegetative Swale: grassed conveyance channel (drainage ditch or swale) with vegetation designed to slow down runoff to allow more time for infiltration into the native soil below.

The "bio-retention cell" LID control may be used to represent bioretention or biofiltration BMPs. For bio-retention cells, a number of LID process layers have been defined in SWMM and these are described below. Table G.1-7 provides parameters required for the standard "bio-retention cell" available in SWMM. The parameters are entered in the LID Control Editor.

**Appendix G: Guidance for Continuous Simulation and Hydromodification Management Sizing Factors**

**Table G.1-7: Parameters for SWMM "Bio-Retention Cell" Module for Hydromodification Management Studies in San Diego**

SWMM Parameter Name	Unit	Use in San Diego
<b><i>Surface</i></b>		
Berm Height also known as Storage Depth	inches	Project-specific
Vegetative Volume Fraction also known as Vegetative Cover Fraction	---	0
Surface Roughness	---	0 (this parameter is not applicable to bio-retention cell)
Surface Slope	---	0 (this parameter is not applicable to bio-retention cell)
<b><i>Soil</i></b>		
Thickness	inches	project-specific
Porosity	---	0.40
Field Capacity	---	0.2
Wilting Point	---	0.1
Conductivity	Inches/hour	5
Conductivity Slope	---	5
Suction Head	inches	1.5
<b><i>Storage</i></b>		
Thickness also known as Height	inches	Project-specific
Void Ratio	---	0.67
Seepage Rate also known as Conductivity	Inches/hour	Conductivity from the storage layer refers to infiltration from the bottom of the structural BMP into the native soil. This variable is project-specific, see Section G.5.1. Use 0 if the bio-retention cell includes an impermeable liner
Clogging Factor	---	0
<b><i>Underdrain</i></b>		
Flow Coefficient Also known as Drain Coefficient	---	Project-specific
Flow Exponent Also known as Drain Exponent	---	Project-specific, typically 0.5
Offset Height Also known as Drain Offset Height	Inches	Project-specific

## Appendix G: Guidance for Continuous Simulation and Hydromodification Management Sizing Factors

### Surface Layer

This process layer receives direct rainfall (and run-on from upstream subcatchments) and the resultant storm water is available for ponding, infiltration, evapotranspiration, or overflow to the outlet. The following parameters are used:

- **Berm Height:** This value is the maximum depth that water can pond above the ground surface before overflow occurs. In some cases, this volume may overlap with the hydraulic representation of existing surface storage or another proposed BMP facility. In any case, the user must avoid double-counting the physical storage volume.
- **Vegetation Volume Fraction:** This represents the surface storage volume that is occupied by the stems and leaves of vegetation within the bio-retention cell.

### Soil Layer

This process layer is typically composed of an amended soil or compost mix. Water that infiltrates into this component is stored in the soil void space and is available for evapotranspiration via plant roots or can percolate into the storage layer below. The following parameters are used:

- **Thickness:** This parameter represents the depth of the amended soil layer.
- **Porosity:** Ratio of pore space volume to soil volume.
- **Field Capacity:** Pore water volume ratio after the soil has been drained.
- **Wilting Point:** Pore water volume ratio after the soil has been dried.
- **Conductivity:** This represents the saturated hydraulic conductivity.
- **Conductivity Slope:** Rate at which conductivity decreases with decreasing soil moisture content.
- **Suction Head:** This represents the capillary tension of water in the soil.

Porosity, conductivity and suction head values as a function of soil texture were included in Table G.1-5. The flow of water through partially saturated soil is less than under fully saturated conditions. The SWMM program accounts for this reduced hydraulic conductivity to predict the rate at which infiltrated water moves through a layer of unsaturated soil when modeling groundwater or LID controls. The conductivity slope is a dimensionless curve-fitting parameter that relates the partially saturated hydraulic conductivity to the soil moisture content.

## Appendix G: Guidance for Continuous Simulation and Hydromodification Management Sizing Factors

### Storage Layer

This process layer is typically composed of porous granular media such as crushed stone or gravel. Water that percolates into this component is stored in the void space and is available for infiltration into the native soil, or collected by an underdrain and discharged to the outlet. The following parameters are used:

- Thickness: This parameter represents the depth of the stone base.
- Void Ratio: Volume of void space relative to volume of solids. Note, by definition, Porosity = Void Ratio ÷ (1 + Void Ratio).
- Seepage Rate: Filtration rate from the granular media into the native soil below. A value of zero should be used if the facility has an impermeable bottom (e.g., concrete) or is underlain by an impermeable liner.
- Clogging Factor: This value is determined by the total volume of treated runoff to completely clog the bottom of the layer divided by the void volume of the layer.

### Drain Layer

This process layer is used to characterize the discharge rate of an underdrain system to the outlet. The following parameters are used:

Flow Coefficient: This value (coupled with the flow exponent described below) characterizes the rate of discharge to the outlet as a function of the height of water stored in the bio-retention cell. The coefficient can be determined by the following equation:

$$C = c_g \left( \frac{605}{ALID} \right) \left( \frac{\pi D^2}{8} \right) \sqrt{\frac{g}{6}}$$

where,

$c_g$  is the orifice discharge coefficient, typically 0.60-0.65 for thin walled plates and higher for thicker walls;

$ALID$  is the cumulative footprint area (ft<sup>2</sup>) of all LID controls;

$D$  is the underdrain orifice diameter (in); and

$g$  is the gravitational constant (32.2 ft/s<sup>2</sup>).

- Flow Exponent: A value of 0.5 should be used to represent flow through an orifice.

## Appendix G: Guidance for Continuous Simulation and Hydromodification Management Sizing Factors

Offset Height: This represents the height of the underdrain above the bottom of the storage layer in the bio-retention cell.

### G.1.6 Flow Frequency and Duration

The continuous simulation model will generate a flow record corresponding to the frequency of the rainfall data input as its output. This flow record must then be processed to determine pre-development and post-project flow rates and durations. Compliance with hydromodification management requirements of this manual is achieved when results for flow duration meet the performance standards. The performance standard is as follows (also presented in Chapter 6 of this manual):

1. For flow rates ranging from 10 percent, 30 percent or 50 percent of the pre-development 2-year runoff event ( $0.1Q_2$ ,  $0.3Q_2$ , or  $0.5Q_2$ ) to the pre-development 10-year runoff event ( $Q_{10}$ ), the post-project discharge rates and durations must not exceed the pre-development rates and durations by more than 10 percent. The specific lower flow threshold will depend on the erosion susceptibility of the receiving stream for the project site (see Section 6.3.4).

To demonstrate that a flow control facility meets the hydromodification management performance standard, first pre-development  $Q_2$  and  $Q_{10}$  must be identified, then a flow duration summary must be generated and compared for pre-development and post-project conditions between the appropriate fraction of  $Q_2$  to  $Q_{10}$ . The range from a fraction of  $Q_2$  to  $Q_{10}$  represents the range of geomorphically significant flows for hydromodification management in San Diego. The upper bound of the range of flows to control is pre-development  $Q_{10}$  for all projects. The lower bound of the range of flows to control, or "lower flow threshold" is a fraction of pre-development  $Q_2$  that is based on the erosion susceptibility of the stream and depends on the specific natural system (stream) that a project will discharge to. Tools have been developed in the March 2011 Final HMP for assessing the erosion susceptibility of the stream (see Section 6.3.4). Simply multiply the pre-development  $Q_2$  by the appropriate fraction (e.g.,  $0.1Q_2$ ) to determine the lower flow threshold.

The following guidelines shall be used for determining flow rates and durations.

#### G.1.6.1 Determining Flow Rates

In the context of hydromodification management in San Diego,  $Q_2$  and  $Q_{10}$  refer to flow rates determined based on either continuous simulation hydrologic modeling or an approved regression equation. Either method may be applied, provided that the same methodology is applied to determination of both  $Q_2$  and  $Q_{10}$  (i.e. cannot mix and match methods at a POC) and be consistent across all POCs for the project (i.e. cannot mix and match methods between multiple POCs).

##### G.1.6.1.1 Determining Flow Rates from Regression Equation

**Appendix G: Guidance for Continuous Simulation and Hydromodification Management Sizing Factors**

The following approved regression equation may be used to determine pre-development  $Q_2$  and  $Q_{10}$ :

$$Q_2 = 3.60 \times A^{0.672} \times P^{0.753}$$

$$Q_{10} = 6.56 \times A^{0.783} \times P^{1.07}$$

where:

- $Q_2$  = 2-year recurrence interval discharge in cubic feet per second
- $Q_{10}$  = 10-year recurrence interval discharge in cubic feet per second
- A = Drainage area in square miles
- P = Mean annual precipitation in inches (Refer to Table 6-1)

When determining  $Q_2$  and  $Q_{10}$  the same methodology must be applied to determination of both flow rates (i.e. cannot mix and match methods at a POC), and be consistent across all POCs for the project (i.e. cannot mix and match methods between multiple POCs).

**TABLE G.1-8. Mean Annual Precipitation**

Gage	Latitude	Longitude	Mean Annual Precipitation (inches)
Oceanside	33.2105556	-117.353333	12.29
Encinitas	33.044567	-117.277213	10.73
Kearney Mesa	32.835118	-117.128456	11.43
Fashion Valley	32.7652778	-117.1758333	10.75
Bonita	32.6561111	-117.0341667	10.88
Poway	32.9522222	-117.0472222	13.08
Fallbrook AP	33.354669	-117.251279	16.18
Lake Wohlford	33.166423	-117.004955	16.63
Ramona	33.0480556	-116.8608333	16.57
Lake Henshaw	33.2386111	-116.7616667	21.58
Borrego	33.2211111	-116.3369444	4.00
Lindbergh	32.7337	-117.1767	10.75
Escondido	33.1197222	-117.095	14.67



**Appendix G: Guidance for Continuous Simulation and Hydromodification Management Sizing Factors**

<b>Gage</b>	<b>Latitude</b>	<b>Longitude</b>	<b>Mean Annual Precipitation (inches)</b>
Flinn Springs	32.847104	-116.857801	15.55
Lake Cuyamaca	32.9894	-116.5867	31.30
Lower Otay	32.6111	-116.9319	11.90
San Onofre	33.3513889	-117.5319444	11.13
San Vicente	32.912082	-116.926513	16.47
Santee	32.839016	-117.024857	13.15

To demonstrate that a flow control facility meets the hydromodification management performance standard, a flow duration summary must be generated and compared for pre-development and post-project conditions. The following guidelines shall be used for determining flow rates and durations.

**G.1.6.1.2 Determining Flow Rates from Continuous Hourly Flow Output**

Flow rates for hydromodification management studies in San Diego must be based on partial duration series analysis of the continuous hourly flow output. Partial duration series frequency calculations consider multiple storm events in a given year. To construct the partial duration series:

1. Parse the continuous hourly flow data into discrete runoff events. The following separation criteria may be used for separation of flow events: a new discrete event is designated when the flow falls below an artificially low flow value based on a fraction of the contributing watershed area (e.g., 0.002 to 0.005 cfs/acre) for a time period of 24 hours. Project applicants may consider other separation criteria provided the separation interval is not more than 24 hours and the criteria is clearly described in the submittal document.
2. Rank the peak flows from each discrete flow event, and compute the return interval or plotting position for each event.

Readers who are unfamiliar with how to compute the partial-duration series should consult reference books or online resources for additional information. For example, Hydrology for Engineers, by Linsley et al, 1982, discusses partial-duration series on pages 373-374 and computing recurrence intervals or plotting positions on page 359. Handbook of Applied Hydrology, by Chow, 1964, contains a detailed discussion of flow frequency analysis, including Annual Exceedance, Partial-Duration and Extreme Value series methods, in Chapter 8. The US Geological Survey (USGS) has several hydrologic study reports available online that use partial duration series statistics (see <http://water.usgs.gov/> and [http://water.usgs.gov/osw/bulletin17b/AGU\\_Langbein\\_1949.pdf](http://water.usgs.gov/osw/bulletin17b/AGU_Langbein_1949.pdf)).

Pre-development  $Q_2$  and  $Q_{10}$  shall be determined from the partial duration analysis for the pre-

## Appendix G: Guidance for Continuous Simulation and Hydromodification Management Sizing Factors

development hourly flow record. Pre-development  $Q_{10}$  is the upper threshold of flow rates to be controlled in the post-project condition. The lower flow threshold is a fraction of the pre-development  $Q_2$  determined based on the erosion susceptibility of the receiving stream. Simply multiply the pre-development  $Q_2$  by the appropriate fraction (e.g.,  $0.1Q_2$ ) to determine the lower flow threshold.

### G.1.6.2 Determining Flow Durations from Continuous Hourly Flow Output

Flow durations must be summarized within the range of flows to control. Flow duration statistics provide a simple summary of how often a particular flow rate is exceeded. To prepare this summary:

1. Rank the entire hourly runoff time series output.
2. Extract the portion of the ranked hourly time series output from the lower flow threshold to the upper flow threshold – this is the portion of the record to be summarized.
3. Divide the applicable portion of the record into 100 equal flow bins (compute the difference between the upper flow threshold (cfs) and lower flow threshold (cfs) and divide this value by 99 to establish the flow bin size).
4. Count the number of hours of flow that fall into each flow bin.

Both pre-development and post-project flow duration summary must be based on the entire length of the flow record. Compare the post-project flow duration summary to the pre-development flow duration summary to determine if it meets performance criteria for post-project flow rates and durations (criteria presented under Section G.1.6).

## G.2 Sizing Factors for Hydromodification Management BMPs

This section presents sizing factors for design of flow control structural BMPs based on the sizing factor method identified in Chapter 6.3.5.1. The sizing factors included here have been updated based on the requirements in the 2015 MS4 permit and are different than the sizing factors presented in previous manuals. These updated values replace the previous sizing factors which shall no longer be used for sizing of hydromodification flow control BMPs. A discussion of the rationale for the update is included below.

The sizing factors included in previous edition was re-printed from the "San Diego BMP Sizing Calculator Methodology," dated January 2012, prepared by Brown and Caldwell (herein "BMP Sizing Calculator Methodology"). These sizing factors were linked to the specific details and descriptions that were presented in the BMP Sizing Calculator Methodology, which included certain assumptions and limited options for modifications. The sizing factors were developed based on the 2007 MS4 Permit. Some of the original sizing factors developed based on the 2007 MS4 Permit and presented in the BMP Sizing Calculator Methodology were not compatible with new requirements of the 2015 MS4 Permit, and therefore were not included in the February 2016 manual. Since publishing the 2016 Model Manual, the Copermittees have developed updated hydromodification factors that more accurately represent the BMP configurations specified in this model manual and account for the revised flow-duration performance standard of the 2015 MS4 Permit (110% exceedance allowance for entire flow-duration curve).

The updated sizing factors were generated using continuous simulation models in USEPA SWMM in accordance with the procedures, methodologies, and values presented in Appendix G.1. All sizing factors are in relation to the effective impervious area draining to the BMP.

The sizing factor method is intended for simple studies that do not include diversion, do not include significant offsite area draining through the project from upstream, and do not include offsite area downstream of the project area. Use of the sizing factors is limited to the specific structural BMPs described in this Appendix. When using the sizing factor methodology, the area fraction reported in the sizing tables represents the plan view area at the surface of the BMP before any ponding occurs. The BMP footprint as defined by this methodology is depicted in Figure G.2-1.

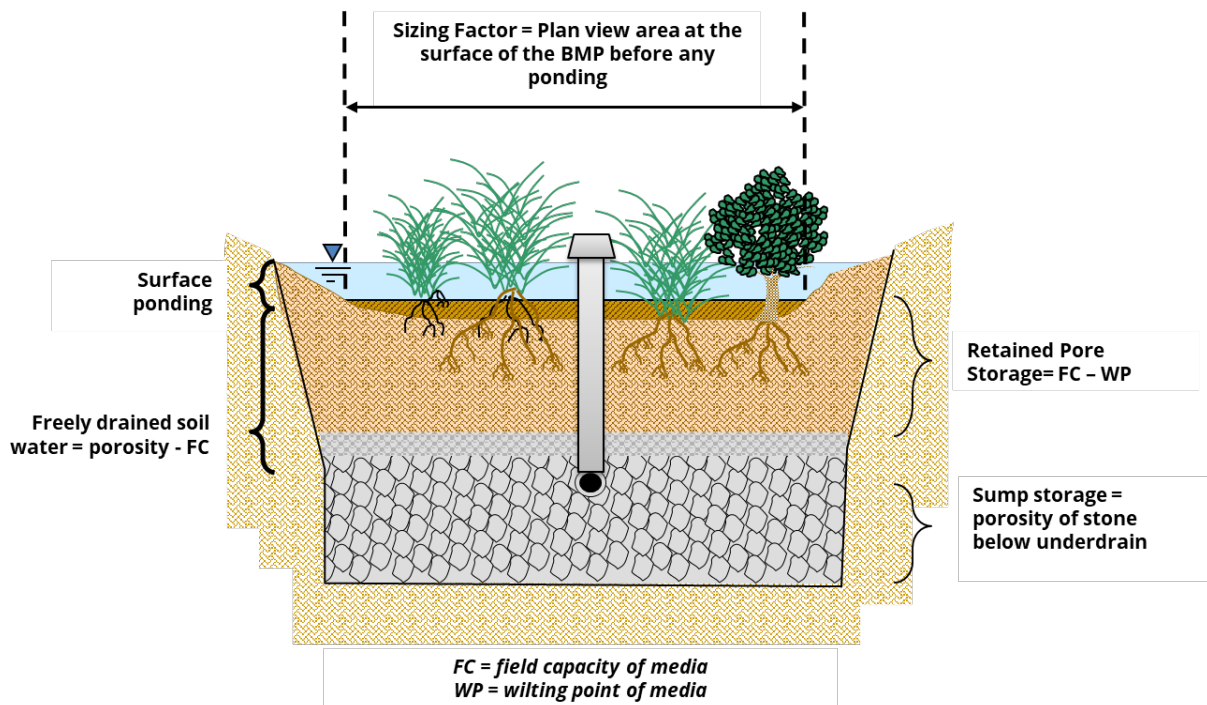

Figure G.2-1: Representation of BMP Footprint for use of Sizing Factors

Sizing factors are available for the following specific structural BMPs:

- **Full infiltration condition:**
  - **Infiltration:** Sizing factors available for A, B, C, and D soils represent surface and/or below-ground structures (infiltration vaults).
- **Partial infiltration condition:**
  - **Biofiltration with partial retention:** Sizing factors available for A, B, C, and D soils represent a bioretention area with bioretention soil media and gravel storage layer, with an underdrain, with gravel storage below the underdrain and a flow control orifice, with no impermeable liner.
- **No infiltration condition:**
  - **Biofiltration:** Sizing factors available for A, B, C, and D soils represent a biofiltration system with bioretention soil media and gravel storage layer, with an underdrain and flow control orifice, with gravel storage, with an impermeable liner (formerly known as flow-through planter and/or biofiltration with impermeable liner)
- **Other:**

## Appendix G: Guidance for Continuous Simulation and Hydromodification Management Sizing Factors

- **Cistern:** Sizing factors available for A, B, C, or D soils represent a vessel with a flow control orifice outlet to meet the hydromodification management performance standard. For this BMP, the sizing factor result is a volume in cubic feet, not a surface footprint in square feet.

Sizing factors were created based on three rainfall basins: Lindbergh Field, Oceanside, and Lake Wohlford.

### *The following information is needed to use the sizing factors:*

- Determine the appropriate rainfall basin for the project site from Figure G.2-2, Rainfall Basin Map
- Hydrologic soil group at the project site (use available information pertaining to existing underlying soil type such as soil maps published by the Natural Resources Conservation Service)
- Pre-development and pre-project slope categories (flat = 0% – 5%, moderate = 5% – 10%, steep = >10%)
- Area tributary to the structural BMP
- Area weighted runoff factor (C) for the area draining to the BMP from Table G.2-1. Note: runoff coefficients and adjustments presented in Appendices B.1 and B.2 are for pollutant control only and are not applicable for hydromodification management studies
- Fraction of  $Q_2$  to control (see Chapter 6.3.4)<sup>28</sup>

When using the sizing factor method, Worksheet G.2-1 may be used to present the calculations of the required minimum areas and/or volumes of BMPs as applicable. Additionally, the “BMP Sizing Spreadsheet V3.0” available at [projectcleanwater.org](http://projectcleanwater.org) implements the sizing factor methodology.

---

<sup>28</sup> All updated sizing factors refer to the “High Susceptibility” threshold value of  $0.1 \cdot Q_2$ , where  $Q_2$  is determined using the Weibull Plotting position and results of the SWMM model runs for unit pervious catchments (refer to Table G.2-2).

Appendix G: Guidance for Continuous Simulation and Hydromodification Management Sizing Factors

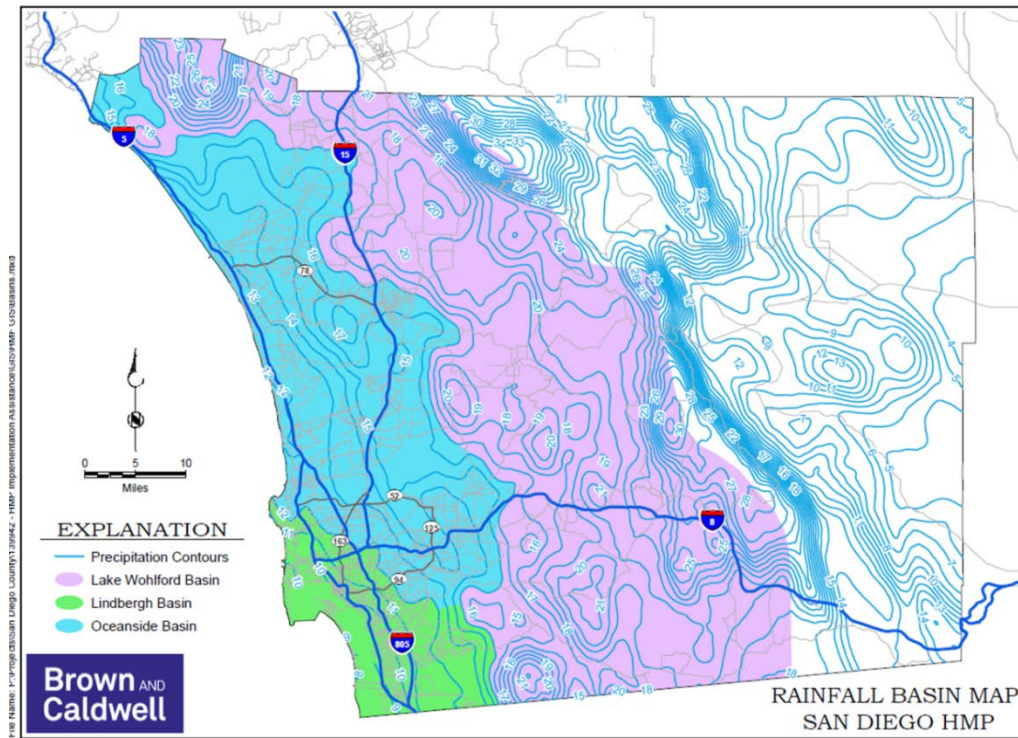

Figure G.2-2: Rainfall Basin Map

Table G.2-1: Runoff factors for surfaces draining to BMPs for Hydromodification Sizing Factors Method

Surface	Runoff Factor
Roofs	1.0
Concrete	1.0
Pervious Concrete	0.10
Porous Asphalt	0.10
Grouted Unit Pavers	1.0
Solid Unit Pavers on granular base, min. 3/16 inch joint space	0.20
Crushed Aggregate	0.10
Turf block	0.10
Amended, mulched soils	0.10
Landscape	0.10

**Appendix G: Guidance for Continuous Simulation and Hydromodification Management Sizing Factors**

**Worksheet G.2-1: Sizing Factor Worksheet**

Site Information			
Project Name:		Hydrologic Unit	
Project Applicant:		Rain Gauge:	
Jurisdiction:		Total Project Area:	
Assessor's Parcel Number:		Low Flow Threshold:	0.1Q <sub>2</sub>
BMP Name:		BMP Type:	

Areas Draining to BMP						Sizing Factors		Minimum BMP Size	
DMA Name	Area (sf)	Soil Type	Pre-Project Slope	Post-Project Surface Type	Runoff Factor (From Table G.2-1)	Surface Area	Volume	Surface Area (sf)	Volume (cf)
<b>Total DMA Area</b>								<b>Minimum BMP Size*</b>	
								<b>Proposed BMP Size*</b>	

\*Minimum BMP Size = Total of rows above.

\*Proposed BMP Size ≥ Minimum BMP size.

## Appendix G: Guidance for Continuous Simulation and Hydromodification Management Sizing Factors

This page was intentionally left blank.



## G.2.1 Unit Runoff Ratios and Low Flow Control Orifice Design

### G.2.1.1 Unit Runoff Ratios

Table G.2-2 presents unit runoff ratios for calculating pre-development  $Q_2$ , to be used when applicable to determine the lower flow threshold for low flow control orifice sizing for biofiltration with partial retention, biofiltration, or cistern BMPs. There is no low flow control orifice in the infiltration BMP. The unit runoff ratios are updated from the previously reported BMP Sizing Calculator methodology ratios to account for changes in modeling methodologies. Unit runoff ratios for "urban" and "impervious" cover categories were not transferred to this manual due to the requirement to control runoff to pre-development condition (see Chapter 6.3.3).

***How to use the unit runoff ratios:***

Obtain unit runoff ratio from Table G.2-2 based on the project's rainfall basin, hydrologic soil group, and pre-development slope (for redevelopment projects, pre-development slope may be considered if historic topographic information is available, otherwise use pre-project slope). Multiply the area tributary to the structural BMP (A, acres) by the unit runoff ratio ( $Q_2$ , cfs/acre) to determine the pre-development  $Q_2$  to determine the lower flow threshold, to use for low flow control orifice sizing.

**Table G.2-2: Unit Runoff Ratios for Sizing Factor Method**

Rain Gauge	Soil	Pre-Project Slope	$Q_2$ (cfs/acre)	$Q_{10}$ (cfs/acre)
Lake Wohlford	A	Flat	0.256	0.518
Lake Wohlford	A	Moderate	0.275	0.528
Lake Wohlford	A	Steep	0.283	0.531
Lake Wohlford	B	Flat	0.371	0.624
Lake Wohlford	B	Moderate	0.389	0.631
Lake Wohlford	B	Steep	0.393	0.633
Lake Wohlford	C	Flat	0.490	0.729
Lake Wohlford	C	Moderate	0.495	0.733
Lake Wohlford	C	Steep	0.496	0.735
Lake Wohlford	D	Flat	0.548	0.784
Lake Wohlford	D	Moderate	0.554	0.788
Lake Wohlford	D	Steep	0.556	0.788

**Appendix G: Guidance for Continuous Simulation and Hydromodification Management Sizing Factors**

Rain Gauge	Soil	Pre-Project Slope	Q <sub>2</sub> (cfs/acre)	Q <sub>10</sub> (cfs/acre)
Oceanside	A	Flat	0.256	0.679
Oceanside	A	Moderate	0.277	0.694
Oceanside	A	Steep	0.285	0.700
Oceanside	B	Flat	0.377	0.875
Oceanside	B	Moderate	0.391	0.879
Oceanside	B	Steep	0.395	0.881
Oceanside	C	Flat	0.488	0.981
Oceanside	C	Moderate	0.497	0.985
Oceanside	C	Steep	0.499	0.986
Oceanside	D	Flat	0.571	0.998
Oceanside	D	Moderate	0.575	0.999
Oceanside	D	Steep	0.576	0.999
Lindbergh	A	Flat	0.057	0.384
Lindbergh	A	Moderate	0.073	0.399
Lindbergh	A	Steep	0.082	0.403
Lindbergh	B	Flat	0.199	0.496
Lindbergh	B	Moderate	0.220	0.509
Lindbergh	B	Steep	0.230	0.513
Lindbergh	C	Flat	0.335	0.601
Lindbergh	C	Moderate	0.349	0.610
Lindbergh	C	Steep	0.354	0.613
Lindbergh	D	Flat	0.429	0.751
Lindbergh	D	Moderate	0.437	0.753
Lindbergh	D	Steep	0.439	0.753

### G.2.1.2 Low Flow Control Orifice Design

When used as hydromodification flow control BMPs, biofiltration with partial retention, biofiltration, and cistern BMPs include a low flow control orifice to control the rate that flow is released from the underdrain or primary outlet. The sizing factors were developed using a standard process for sizing the low flow control orifice, therefore BMPs designed using the sizing factor method must size the low flow control orifice using the same basis. The low flow control orifice must be designed to release the lower flow threshold flow rate (fraction of pre-development  $Q_2$ ) when the water surface elevation in the BMP is equal to the crest elevation of the next outflow structure. To size the low flow control orifice, determine the head on the orifice measured from the bottom of the orifice to the minimum elevation of the next outflow structure of the BMP. The next outflow structure is typically the BMP overflow structure, except in some multi-use BMPs (e.g., BMPs that are designed for flood control in addition to hydromodification management). In this application, the difference between the bottom of the orifice and the centroid of the orifice is small relative to the total head for the calculation and may be neglected in the calculation by measuring from the orifice invert. This calculation is automated in the “BMP Sizing Spreadsheet V3.0” posted on [www.projectcleanwater.org](http://www.projectcleanwater.org).

#### *Steps to size the low flow control orifice:*

- Determine pre-development  $Q_2$  using the unit runoff ratios above.
- Multiply pre-development  $Q_2$  by 0.1 to determine the low flow threshold flow rate. Note sizing factors are only available for streams with high susceptibility to erosion where the low flow threshold is  $0.1Q_2$ .
- Determine the head (H) on the orifice measured from the bottom of the orifice to the minimum elevation of the next outflow structure of the BMP.
- Use the orifice equation (below) and solve for the maximum orifice area to release the lower flow threshold flow rate.
- Consider how the orifice will be created. Determine the constructible dimension(s) (e.g., a standard drill bit diameter) that will produce an orifice with an area equal to or less than the maximum orifice area. The final orifice area determined based on constructible dimensions shall not exceed the maximum orifice area.

$$Q = C \times A \times (64.4 \times H)^{0.5}$$

where:

- Q = Flow rate in cubic feet per second
- C = Orifice coefficient; in this application use  $C = 0.65$
- A = Area in square feet
- H = Head in feet

## G.2.2 Sizing Factors for "Infiltration" BMP

Table G.2-3 presents sizing factors for calculating the required surface area (A) for an infiltration BMP. There is no underdrain and therefore no low flow orifice in the infiltration BMP. Sizing factors were developed for hydrologic soil groups A, B, C, and D. This BMP is generally not applicable in hydrologic soil groups C and D, but applicants have the option if there are no geotechnical or water balance issues and the underlying design infiltration rate for the BMP is greater than 0.5 inches per hour. The infiltration BMP is a surface ponding feature that allows infiltration into the native or amended soils of the BMP surface.

- **Ponding layer:** a nominal 36-inch ponding layer shall be included below the overflow elevation.
- **Design infiltration rate:** the design infiltration rate shall be greater than 0.5 inches per hour.
- **Overflow structure:** San Diego Regional Standard Drawing Type I Catch Basin (D-29). For the purposes of hydromodification flow control other type of overflow structures are allowed.

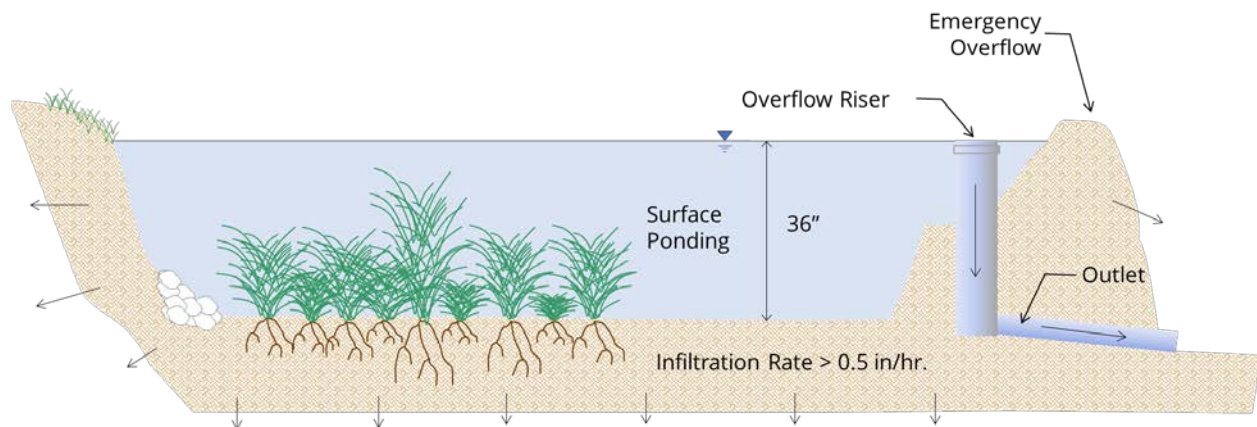

**Infiltration BMP Example Illustration**

### *How to use the sizing factors for flow control BMP Sizing:*

Obtain sizing factors from Table G.2-3 based on the project's lower flow threshold fraction of  $Q_2$ , hydrologic soil group, pre-project slope, and rain gauge (rainfall basin). Multiply the area tributary to the structural BMP (A, square feet) by the area weighted runoff factor (C, unitless) (see Table G.2-1) by the sizing factors to determine the required surface area (A, square feet) for the infiltration BMP. The civil engineer shall provide the necessary surface area of the BMP on the plans.

### *Additional steps to use this BMP as a combined pollutant control and flow control BMP:*

The BMP sized using the sizing factors in Table G.2-3 meets both pollutant control and flow control

## Appendix G: Guidance for Continuous Simulation and Hydromodification Management Sizing Factors

requirements.

**Table G.2-3: Sizing Factors for Hydromodification Flow Control Infiltration BMPs Designed Using Sizing Factor Method**

Lower Flow Threshold	Soil Group	Pre-Project Slope	Rain Gauge	A
0.1Q <sub>2</sub>	A	Flat	Lindbergh	0.055
0.1Q <sub>2</sub>	A	Moderate	Lindbergh	0.055
0.1Q <sub>2</sub>	A	Steep	Lindbergh	0.055
0.1Q <sub>2</sub>	B	Flat	Lindbergh	0.045
0.1Q <sub>2</sub>	B	Moderate	Lindbergh	0.045
0.1Q <sub>2</sub>	B	Steep	Lindbergh	0.045
0.1Q <sub>2</sub>	C	Flat	Lindbergh	0.035
0.1Q <sub>2</sub>	C	Moderate	Lindbergh	0.035
0.1Q <sub>2</sub>	C	Steep	Lindbergh	0.035
0.1Q <sub>2</sub>	D	Flat	Lindbergh	0.030
0.1Q <sub>2</sub>	D	Moderate	Lindbergh	0.030
0.1Q <sub>2</sub>	D	Steep	Lindbergh	0.030
0.1Q <sub>2</sub>	A	Flat	Oceanside	0.060
0.1Q <sub>2</sub>	A	Moderate	Oceanside	0.060
0.1Q <sub>2</sub>	A	Steep	Oceanside	0.060
0.1Q <sub>2</sub>	B	Flat	Oceanside	0.050
0.1Q <sub>2</sub>	B	Moderate	Oceanside	0.050
0.1Q <sub>2</sub>	B	Steep	Oceanside	0.050
0.1Q <sub>2</sub>	C	Flat	Oceanside	0.050
0.1Q <sub>2</sub>	C	Moderate	Oceanside	0.050
0.1Q <sub>2</sub>	C	Steep	Oceanside	0.045
0.1Q <sub>2</sub>	D	Flat	Oceanside	0.035

**Appendix G: Guidance for Continuous Simulation and Hydromodification Management Sizing Factors**

Lower Flow Threshold	Soil Group	Pre-Project Slope	Rain Gauge	A
0.1Q <sub>2</sub>	D	Moderate	Oceanside	0.035
0.1Q <sub>2</sub>	D	Steep	Oceanside	0.035
0.1Q <sub>2</sub>	A	Flat	L Wohlford	0.085
0.1Q <sub>2</sub>	A	Moderate	L Wohlford	0.085
0.1Q <sub>2</sub>	A	Steep	L Wohlford	0.085
0.1Q <sub>2</sub>	B	Flat	L Wohlford	0.070
0.1Q <sub>2</sub>	B	Moderate	L Wohlford	0.070
0.1Q <sub>2</sub>	B	Steep	L Wohlford	0.070
0.1Q <sub>2</sub>	C	Flat	L Wohlford	0.055
0.1Q <sub>2</sub>	C	Moderate	L Wohlford	0.055
0.1Q <sub>2</sub>	C	Steep	L Wohlford	0.055
0.1Q <sub>2</sub>	D	Flat	L Wohlford	0.040
0.1Q <sub>2</sub>	D	Moderate	L Wohlford	0.040
0.1Q <sub>2</sub>	D	Steep	L Wohlford	0.040

Q<sub>2</sub> = 2-year pre-project flow rate based upon partial duration analysis of long-term hourly rainfall records

A = Surface area (at surface of the BMP before any ponding occurs) sizing factor for flow control

### G.2.3 Sizing Factors for Biofiltration with Partial Retention

Table G.2-4 presents sizing factors for calculating the required surface area (A) for a biofiltration with partial retention BMP. The BMPs consist of four layers:

- **Ponding layer:** 12-inches active storage, [minimum] 12-inches of freeboard above overflow relief
- **Media Layer:** 18-inches of soil [bioretention soil media]
- **Filter Course:** 6-inches
- **Storage layer:** 18-inches of gravel at 40 percent porosity for A and B soils and 12-inches of gravel at 40 percent porosity for C and D soils. The underdrain offset for A and B soils shall be 18-inches, for C soils it shall be 6-inches and for D soils it shall be 3-inches.
- **Overflow structure:** San Diego Regional Standard Drawing Type I Catch Basin (D-29). For the purposes of hydromodification flow control other type of overflow structures are allowed.

This BMP does not include an impermeable layer at the bottom of the facility to prevent infiltration into underlying soils, regardless of hydrologic soil group. If a facility is to be lined, the designer must use the sizing factors for biofiltration (Refer to Appendix G.2.4).

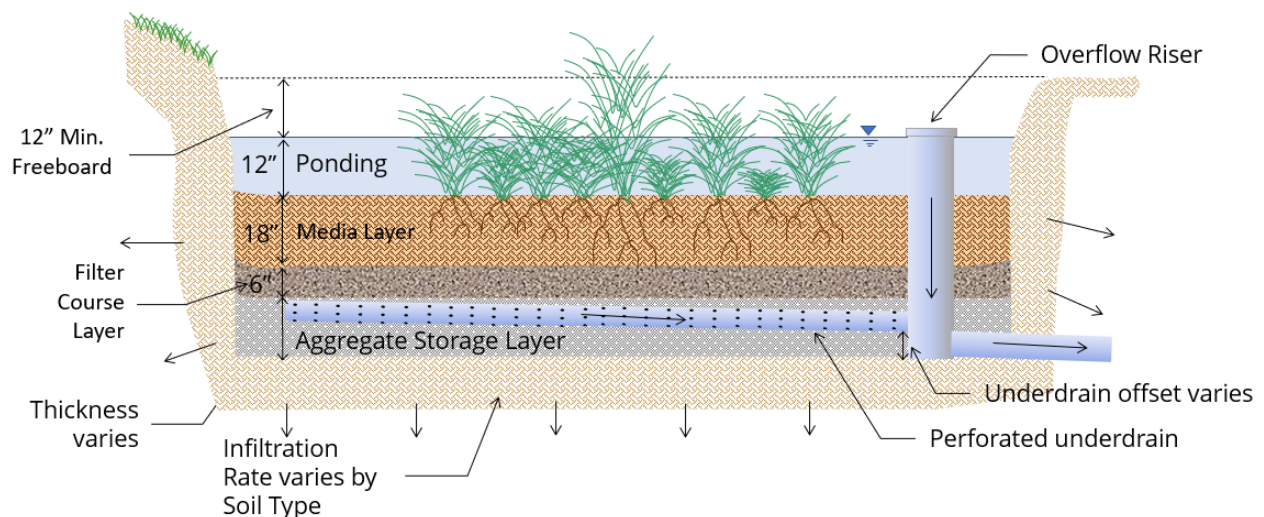

#### Biofiltration with Partial Retention BMP Example Illustration

##### *How to use the sizing factors for flow control BMP Sizing:*

Obtain sizing factors from Table G.2-4 based on the project's lower flow threshold fraction of  $Q_2$ , hydrologic soil group, pre-project slope, and rain gauge (rainfall basin). Multiply the area tributary to the structural BMP (A, square feet) by the area weighted runoff factor (C, unitless) (see Table G.2-1)

## Appendix G: Guidance for Continuous Simulation and Hydromodification Management Sizing Factors

by the sizing factors to determine the required surface area (A, square feet). Select a low flow control orifice for the underdrain that will discharge the lower flow threshold flow at the overflow riser elevation. Standard head (H) for this calculation (based on the standard detail) is 3.0 feet for A or B soils, 3.5 feet for C soils, or 3.75 feet for D soils. The civil engineer shall provide the necessary surface area of the BMP and the underdrain and orifice detail on the plans.

### *Additional steps to use this BMP as a combined pollutant control and flow control BMP:*

The BMP sized using the sizing factors in Table G.2-4 meets both pollutant control and flow control requirements.

**Table G.2-4: Sizing Factors for Hydromodification Flow Control Biofiltration with Partial Retention BMPs Designed Using Sizing Factor Method**

Lower Flow Threshold	Soil Group	Pre-Project Slope	Aggregate below low orifice invert (inches)	Rain Gauge	A
0.1Q <sub>2</sub>	A	Flat	18	Lindbergh	0.080
0.1Q <sub>2</sub>	A	Moderate	18	Lindbergh	0.080
0.1Q <sub>2</sub>	A	Steep	18	Lindbergh	0.080
0.1Q <sub>2</sub>	B	Flat	18	Lindbergh	0.065
0.1Q <sub>2</sub>	B	Moderate	18	Lindbergh	0.065
0.1Q <sub>2</sub>	B	Steep	18	Lindbergh	0.060
0.1Q <sub>2</sub>	C	Flat	6	Lindbergh	0.050
0.1Q <sub>2</sub>	C	Moderate	6	Lindbergh	0.050
0.1Q <sub>2</sub>	C	Steep	6	Lindbergh	0.050
0.1Q <sub>2</sub>	D	Flat	3	Lindbergh	0.050
0.1Q <sub>2</sub>	D	Moderate	3	Lindbergh	0.050
0.1Q <sub>2</sub>	D	Steep	3	Lindbergh	0.050
0.1Q <sub>2</sub>	A	Flat	18	Oceanside	0.080
0.1Q <sub>2</sub>	A	Moderate	18	Oceanside	0.075
0.1Q <sub>2</sub>	A	Steep	18	Oceanside	0.075
0.1Q <sub>2</sub>	B	Flat	18	Oceanside	0.070



**Appendix G: Guidance for Continuous Simulation and Hydromodification Management Sizing Factors**

Lower Flow Threshold	Soil Group	Pre-Project Slope	Aggregate below low orifice invert (inches)	Rain Gauge	A
0.1Q <sub>2</sub>	B	Moderate	18	Oceanside	0.070
0.1Q <sub>2</sub>	B	Steep	18	Oceanside	0.070
0.1Q <sub>2</sub>	C	Flat	6	Oceanside	0.070
0.1Q <sub>2</sub>	C	Moderate	6	Oceanside	0.070
0.1Q <sub>2</sub>	C	Steep	6	Oceanside	0.070
0.1Q <sub>2</sub>	D	Flat	3	Oceanside	0.070
0.1Q <sub>2</sub>	D	Moderate	3	Oceanside	0.070
0.1Q <sub>2</sub>	D	Steep	3	Oceanside	0.070
0.1Q <sub>2</sub>	A	Flat	18	L Wohlford	0.110
0.1Q <sub>2</sub>	A	Moderate	18	L Wohlford	0.110
0.1Q <sub>2</sub>	A	Steep	18	L Wohlford	0.105
0.1Q <sub>2</sub>	B	Flat	18	L Wohlford	0.090
0.1Q <sub>2</sub>	B	Moderate	18	L Wohlford	0.085
0.1Q <sub>2</sub>	B	Steep	18	L Wohlford	0.085
0.1Q <sub>2</sub>	C	Flat	6	L Wohlford	0.065
0.1Q <sub>2</sub>	C	Moderate	6	L Wohlford	0.065
0.1Q <sub>2</sub>	C	Steep	6	L Wohlford	0.065
0.1Q <sub>2</sub>	D	Flat	3	L Wohlford	0.060
0.1Q <sub>2</sub>	D	Moderate	3	L Wohlford	0.060
0.1Q <sub>2</sub>	D	Steep	3	L Wohlford	0.060

Q<sub>2</sub> = 2-year pre-project flow rate based upon partial duration analysis of long-term hourly rainfall records

A = Surface area (at surface of the BMP before any ponding occurs) sizing factor for flow control

### G.2.4 Sizing Factors for Biofiltration

Table G.2-5 presents sizing factors for calculating the required surface area (A) for a biofiltration BMP (formerly known as flow-through planter and/or biofiltration BMP with impermeable liner). The BMPs consist of four layers:

- **Ponding layer:** 12-inches active storage, [minimum] 12-inches of freeboard above overflow relief
- **Media layer:** 18-inches of soil [bioretention soil media]
- **Filter Course:** 6-inches
- **Storage layer:** 12-inches of gravel at 40 percent porosity. The underdrain offset shall be 3-inches.
- **Overflow structure:** San Diego Regional Standard Drawing Type I Catch Basin (D-29). For the purposes of hydromodification flow control other type of overflow structures are allowed.

This BMP includes an impermeable liner to prevent infiltration into underlying soils.

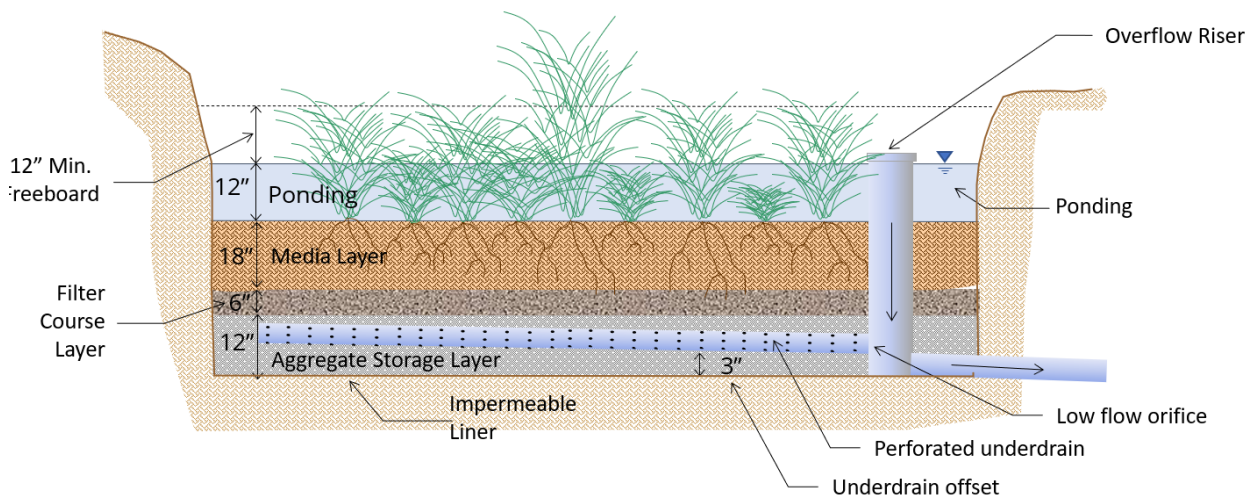

**Biofiltration BMP Example Illustration**

***How to use the sizing factors for flow control BMP Sizing:***

Obtain sizing factors from Table G.2-5 based on the project's lower flow threshold fraction of  $Q_2$ , hydrologic soil group, pre-project slope, and rain gauge (rainfall basin). Multiply the area tributary to the structural BMP (A, square feet) by the area weighted runoff factor (C, unitless) (see Table G.2-1) by the sizing factors to determine the required surface area (A, square feet). Select a low flow control orifice for the underdrain that will discharge the lower flow threshold flow at the overflow riser elevation. Standard head (H) for this calculation (based on the standard detail) is 3.75 feet for all soil

## Appendix G: Guidance for Continuous Simulation and Hydromodification Management Sizing Factors

groups. The civil engineer shall provide the necessary surface area of the BMP and the underdrain and orifice detail on the plans.

### *Additional steps to use this BMP as a combined pollutant control and flow control BMP:*

The BMP sized using the sizing factors in Table G.2-5 meets both pollutant control and flow control requirements except for surface drawdown requirements. Applicant must perform surface drawdown calculations and if needed develop a vector management plan (Refer to Section 6.3.7) or revise the BMP design to meet the drawdown requirements. If changes are made to the BMP design applicants must perform site specific continuous simulation modeling (Refer to Appendix G).

**Table G.2-5: Sizing Factors for Hydromodification Flow Control Biofiltration BMPs Designed Using Sizing Factor Method**

Lower Flow Threshold	Soil Group	Pre-Project Slope	Rain Gauge	A
0.1Q <sub>2</sub>	A	Flat	Lindbergh	0.320
0.1Q <sub>2</sub>	A	Moderate	Lindbergh	0.300
0.1Q <sub>2</sub>	A	Steep	Lindbergh	0.285
0.1Q <sub>2</sub>	B	Flat	Lindbergh	0.105
0.1Q <sub>2</sub>	B	Moderate	Lindbergh	0.100
0.1Q <sub>2</sub>	B	Steep	Lindbergh	0.095
0.1Q <sub>2</sub>	C	Flat	Lindbergh	0.055
0.1Q <sub>2</sub>	C	Moderate	Lindbergh	0.050
0.1Q <sub>2</sub>	C	Steep	Lindbergh	0.050
0.1Q <sub>2</sub>	D	Flat	Lindbergh	0.050
0.1Q <sub>2</sub>	D	Moderate	Lindbergh	0.050
0.1Q <sub>2</sub>	D	Steep	Lindbergh	0.050
0.1Q <sub>2</sub>	A	Flat	Oceanside	0.150
0.1Q <sub>2</sub>	A	Moderate	Oceanside	0.140
0.1Q <sub>2</sub>	A	Steep	Oceanside	0.135
0.1Q <sub>2</sub>	B	Flat	Oceanside	0.085
0.1Q <sub>2</sub>	B	Moderate	Oceanside	0.085

**Appendix G: Guidance for Continuous Simulation and Hydromodification Management Sizing Factors**

Lower Flow Threshold	Soil Group	Pre-Project Slope	Rain Gauge	A
0.1Q <sub>2</sub>	B	Steep	Oceanside	0.085
0.1Q <sub>2</sub>	C	Flat	Oceanside	0.075
0.1Q <sub>2</sub>	C	Moderate	Oceanside	0.075
0.1Q <sub>2</sub>	C	Steep	Oceanside	0.075
0.1Q <sub>2</sub>	D	Flat	Oceanside	0.070
0.1Q <sub>2</sub>	D	Moderate	Oceanside	0.070
0.1Q <sub>2</sub>	D	Steep	Oceanside	0.070
0.1Q <sub>2</sub>	A	Flat	L Wohlford	0.285
0.1Q <sub>2</sub>	A	Moderate	L Wohlford	0.275
0.1Q <sub>2</sub>	A	Steep	L Wohlford	0.270
0.1Q <sub>2</sub>	B	Flat	L Wohlford	0.150
0.1Q <sub>2</sub>	B	Moderate	L Wohlford	0.145
0.1Q <sub>2</sub>	B	Steep	L Wohlford	0.145
0.1Q <sub>2</sub>	C	Flat	L Wohlford	0.070
0.1Q <sub>2</sub>	C	Moderate	L Wohlford	0.070
0.1Q <sub>2</sub>	C	Steep	L Wohlford	0.070
0.1Q <sub>2</sub>	D	Flat	L Wohlford	0.060
0.1Q <sub>2</sub>	D	Moderate	L Wohlford	0.060
0.1Q <sub>2</sub>	D	Steep	L Wohlford	0.060

Q<sub>2</sub> = 2-year pre-project flow rate based upon partial duration analysis of long-term hourly rainfall records  
 flow control

A = Surface area (at surface of the BMP before any ponding occurs) sizing factor for flow control

### G.2.5 Sizing Factors for "Cistern" BMP

Table G.2-6 presents sizing factors for calculating the required volume (V) for a cistern BMP. In this context, a "cistern" is a detention facility that stores runoff and releases it at a controlled rate. A cistern can be a component of a harvest and use system, however the sizing factor method will not account for any retention occurring in the system. The sizing factors were developed assuming runoff is released from the cistern. The sizing factors presented in this section are to meet the hydromodification management performance standard only. The cistern BMP is based on the following assumptions:

- **Cistern configuration:** The cistern is modeled as a 4-foot tall vessel. However, designers could use other configurations (different cistern heights), as long as the lower outlet orifice is sized to properly restrict outflows and the minimum required volume is provided.
- **Cistern upper outlet:** The upper outlet from the cistern would consist of a weir or other flow control structure with the overflow invert set at an elevation of 7/8 of the water height associated with the required volume of the cistern – V. For the assumed 4-foot water depth in the cistern associated with the sizing factor analysis, the overflow invert is assumed to be located at an elevation of 3.5 feet above the bottom of the cistern. The overflow weir would be sized to pass the peak design flow based on the tributary drainage area.

#### *How to use the sizing factors:*

Obtain sizing factors from Table G.2-6 based on the project's lower flow threshold fraction of  $Q_2$ , hydrologic soil group, pre-project slope, and rain gauge (rainfall basin). Multiply the area tributary to the structural BMP (A, square feet) by the area weighted runoff factor (C, unitless) (see Table G.2-1) by the sizing factors to determine the required volume (V, cubic feet). Select a low flow control orifice that will discharge the lower flow threshold flow at the overflow elevation (i.e. when there is 3.5 feet of head over the lower outlet orifice or adjusted head as appropriate if the cistern overflow elevation is not 3.5 feet tall). The civil engineer shall provide the necessary volume of the BMP and the lower outlet orifice detail on the plans.

#### **Additional steps to use this BMP as a combined pollutant control and flow control BMP:**

A cistern could be a component of a full retention, partial retention, or no retention BMP depending on how the outflow is disposed. However, use of the sizing factor method for design of the cistern in a combined pollutant control and flow control system is not recommended. The sizing factor method for designing a cistern does not account for any retention or storage occurring in BMPs combined with the cistern (i.e., cistern sized using sizing factors may be larger than necessary because sizing factor method does not recognize volume losses occurring in other elements of a combined system). Furthermore, when the cistern is designed using the sizing factor method, the cistern outflow must be set to the low flow threshold flow for the drainage area, which may be inconsistent with

## Appendix G: Guidance for Continuous Simulation and Hydromodification Management Sizing Factors

requirements for other elements of a combined system. To optimize a system in which a cistern provides temporary storage for runoff to be either used onsite (harvest and use), infiltrated, or biofiltered, project-specific continuous simulation modeling is recommended. Refer to Sections 5.6 and 6.3.6.

**Table G.2-6: Sizing Factors for Hydromodification Flow Control Cistern BMPs Designed Using Sizing Factor Method**

Lower Flow Threshold	Soil Group	Pre-Project Slope	Rain Gauge	V
0.1Q <sub>2</sub>	A	Flat	Lindbergh	0.54
0.1Q <sub>2</sub>	A	Moderate	Lindbergh	0.51
0.1Q <sub>2</sub>	A	Steep	Lindbergh	0.49
0.1Q <sub>2</sub>	B	Flat	Lindbergh	0.19
0.1Q <sub>2</sub>	B	Moderate	Lindbergh	0.18
0.1Q <sub>2</sub>	B	Steep	Lindbergh	0.18
0.1Q <sub>2</sub>	C	Flat	Lindbergh	0.11
0.1Q <sub>2</sub>	C	Moderate	Lindbergh	0.11
0.1Q <sub>2</sub>	C	Steep	Lindbergh	0.11
0.1Q <sub>2</sub>	D	Flat	Lindbergh	0.09
0.1Q <sub>2</sub>	D	Moderate	Lindbergh	0.09
0.1Q <sub>2</sub>	D	Steep	Lindbergh	0.09
0.1Q <sub>2</sub>	A	Flat	Oceanside	0.26
0.1Q <sub>2</sub>	A	Moderate	Oceanside	0.25
0.1Q <sub>2</sub>	A	Steep	Oceanside	0.25
0.1Q <sub>2</sub>	B	Flat	Oceanside	0.16
0.1Q <sub>2</sub>	B	Moderate	Oceanside	0.16
0.1Q <sub>2</sub>	B	Steep	Oceanside	0.16
0.1Q <sub>2</sub>	C	Flat	Oceanside	0.14
0.1Q <sub>2</sub>	C	Moderate	Oceanside	0.14

**Appendix G: Guidance for Continuous Simulation and Hydromodification Management Sizing Factors**

Lower Flow Threshold	Soil Group	Pre-Project Slope	Rain Gauge	V
0.1Q <sub>2</sub>	C	Steep	Oceanside	0.14
0.1Q <sub>2</sub>	D	Flat	Oceanside	0.12
0.1Q <sub>2</sub>	D	Moderate	Oceanside	0.12
0.1Q <sub>2</sub>	D	Steep	Oceanside	0.12
0.1Q <sub>2</sub>	A	Flat	L Wohlford	0.53
0.1Q <sub>2</sub>	A	Moderate	L Wohlford	0.49
0.1Q <sub>2</sub>	A	Steep	L Wohlford	0.49
0.1Q <sub>2</sub>	B	Flat	L Wohlford	0.28
0.1Q <sub>2</sub>	B	Moderate	L Wohlford	0.28
0.1Q <sub>2</sub>	B	Steep	L Wohlford	0.28
0.1Q <sub>2</sub>	C	Flat	L Wohlford	0.14
0.1Q <sub>2</sub>	C	Moderate	L Wohlford	0.14
0.1Q <sub>2</sub>	C	Steep	L Wohlford	0.14
0.1Q <sub>2</sub>	D	Flat	L Wohlford	0.12
0.1Q <sub>2</sub>	D	Moderate	L Wohlford	0.12
0.1Q <sub>2</sub>	D	Steep	L Wohlford	0.12

Q<sub>2</sub> = 2-year pre-project flow rate based upon partial duration analysis of long-term hourly rainfall records  
V = Cistern volume sizing factor

Appendix



ESCONDIDO STORM WATER DESIGN MANUAL

# Guidance for Investigating Potential Critical Coarse Sediment Yield Areas



# Appendix H Guidance for Investigating Potential Critical Coarse Sediment Yield Areas

The following guidance provides methodologies for protecting CCSYAs:

- H.1. Step 1: Identify CCSYAs
- H.2. Step 2: Avoidance of Onsite CCSYAs
- H.3. Step 3: Bypass Onsite and Upstream CCSYAs
- H.4. Step 4: Demonstrate No Net Impact
- H.5. References
- H.6. PCCSYAs: Regional WMAA Maps
- H.7. Downstream System Sensitivity to Coarse Sediment
- H.8. Calculation Methodology for Ep and Sp
- H.9. Mitigation Measures Fact Sheets

## Appendix H: Guidance for Investigation Potential Critical Coarse Sediment Yield Areas

### H.1 Step 1: Identify CCSYAs

A CCSYA is an active or potential source of bed sediment to downstream channel reaches. When a Priority Development Project (PDP) is constructed, it has the potential to negatively impact characteristics of sediment supply and delivery which can lead to degradation of receiving waters. In order to prevent these impacts, PDP applicants must examine the tributary areas identified in their storm water management plans and identify sources of critical coarse sediment within the following areas:

- **Onsite CCSYAs:** CCSYAs identified within the project's property boundary as indicated in the SWQMP. Refer to Section 1.3 for defining a project.
- **Upstream CCSYAs:** CCSYAs identified within the drainage area draining through the project's property boundary as indicated in the SWQMP. Refer to Section 1.3 for defining a project.

Applicants must first identify potential critical coarse sediment yield areas (PCCSYAs) using one of the methods presented in Section H.1.1. Applicants may then elect to accept the mapping results and remove the "potential" designation, or may elect to further refine the results of the mapping through consideration of the refinement methods outlined in Section H.1.2. At the end of Step 1, applicants will have identified CCSYAs that must be avoided and bypassed by the project.

#### H.1.1 Identification Methods

Applicants must identify both onsite and upstream CCSYAs by referring to the Regional Watershed Management Area Analysis PCCSYA maps provided in Appendix H.6.

#### H.1.2 Refinement Options

After identifying PCCSYAs using one of the methods above, the applicant may elect to accept the mapping results and remove the "potential" designation, or may elect to further refine the results of the mapping through consideration of one or more of the refinement methods outlined below.

##### H.1.2.1 Depositional Analysis

Areas identified as PCCSYAs may be removed from consideration if it is demonstrated that these sources are deposited into existing systems prior to reaching the first downstream unlined water of the state. Systems resulting in deposition may include existing natural sinks, existing structural BMPs, existing hardened MS4 systems, or other existing similar features that produce a peak velocity from the discrete 2-year, 24-hour runoff event of less than three feet per second in the system being analyzed. Applicants electing to perform depositional analysis to refine PCCSYA mapping must refer to the detailed guidance provided in Appendix H.7.1.

## **Appendix H: Guidance for Investigation Potential Critical Coarse Sediment Yield Areas**

### **H.1.2.2 Threshold Channel Analysis**

Areas identified as PCCSYAs may be removed from consideration if they discharge to a “threshold channel” that does not exhibit characteristics associated with significant bed load movement during design flows. Applicants electing to perform threshold channel analysis to refine PCCSYA mapping must refer to the detailed guidance provided in Appendix H.7.2.

### **H.1.2.3 Coarse Sediment Source Area Verification**

Areas identified as PCCSYAs may be removed from consideration if an applicant demonstrates that these areas actually consist of fine grained sediment. Applicants electing to perform coarse sediment source area verification to refine PCCSYA mapping must refer to the detailed guidance provided in Appendix H.7.3.

### **H.1.2.4 Verification of Geomorphic Landscape Units (GLUs)**

Areas identified as PCCSYAs may be refined through verification of GLUs. If this method is used, applicants must refer to detailed guidance provided in Appendix H.6.1.

### H.2 Step 2: Avoidance of Onsite CCSYAs

A key element of preserving the stability of receiving waters is to avoid changes in bed sediment supply by avoiding development on CCSYAs. Avoidance is best achieved through proper site design. The following are some potential strategies that should be considered while determining the site layout to avoid CCSYAs:

- The civil engineer shall designate onsite CCSYAs that are to be avoided (undisturbed) for the purpose of preserving coarse sediment yield. When feasible, use and/or access restriction should be established for these areas.
- Minimize new impervious footprint. Refer to SD-3 in Chapter 4 for guidance on minimizing impervious footprint.

If onsite CCSYAs are not avoided per the metrics defined below, the applicant must demonstrate no net impact to the receiving water using guidance in Appendix H.4.

#### H.2.1 Avoidance Metrics

If the applicant has identified onsite CCSYAs using the Regional Watershed Management Area Analysis PCCSYA maps provided in Appendix H.6, encroachments of up to 5% into the onsite CCSYAs may be permitted (encroachments are measured at the POC scale and must be less than or equal to 5% for each POC). Refer to Appendix H.6.3 for supporting rationale for 5% encroachment.

### H.3 Step 3: Bypass Onsite and Upstream CCSYAs

Another key element of preserving the stability of receiving waters is to maintain current bed sediment supply characteristics through effective bypass of onsite and upstream sediment sources. Upstream bed sediment sources may include overland flow from CCSYAs and/or concentrated channel flows. Applicants must ensure both onsite and upstream sources of bed sediment are effectively bypassed through their project. If onsite and/or upstream CCSYAs are not effectively bypassed per the criteria below, applicant must implement mitigation measures presented in Appendix H.4.

#### H.3.1 Bypass CCSYAs from Hillslopes

Both onsite and upstream hillslopes mapped as CCSYAs must be effectively bypassed through and/or around the proposed project site.

## Appendix H: Guidance for Investigation Potential Critical Coarse Sediment Yield Areas

- Proposed hardened drainage systems (e.g. storm drains, drainage ditches) that convey the bed sediment from the hillslopes to the downstream waters of the state should maintain a peak velocity from the discrete 2-year, 24-hour runoff event greater than three feet per second.
  - When drainage ditches are proposed for bypass, this could be achieved by designing them to the minimum dimensions listed in the San Diego Regional Standard drawing D-75.
  - When an 18” concrete storm drain is proposed for bypass, this velocity may typically be achieved by maintaining a storm drain slope of  $\geq 0.5\%$ . In instances where 2-year, 24-hour peak flow rates associated with the storm drain are less than 1.1 cfs, applicants may refer to the table below for minimum slopes needed to maintain three feet per second. Applicants may interpolate the values from the table below, or may elect to perform more detailed cleansing velocity calculations presented in Appendix H.7.1.

2-year, 24-Hour Peak Flow (cfs)	Minimum Slope for 18” Concrete Storm Drain
<0.25	n/a, this PCCSYA is considered-de minimis.
0.25	2%
0.50	1%
1.10	0.5%

- Storm water runoff that contains the bed sediment from CCSYAs must not be routed through detention basins or other facilities with restricted outlets that will trap sediment. Bypass systems shall be designed as necessary so that the bed material is conveyed to the downstream receiving water. Structural BMPs (including most flow-thru BMPs) are likely to trap sediment.
- For scenarios where a BMP must be constructed to treat offsite drainage area and there are CCSYAs outside of the project footprint, it may be feasible to achieve mitigation by construction of an outlet structure that can convey the bed load to the downstream receiving water and clear water through a bypass structure to a BMP.
- Proposed crossings (culverts, driveways, etc.) should not impede the transport of upstream critical coarse sediment. Crossings should be designed to avoid headwater conditions that would result in the trapping/settling of sediment.

### H.3.2 Bypass CCSYAs from Channels

Projects that effectively avoid and bypass CCSYAs mapped in Step 1 (i.e., Appendix H.1) of this guidance are not required to take specific action to ensure bypass of channel flows. This guidance does not set forth channel bypass criteria for this scenario because it recognizes that existing regulator

## Appendix H: Guidance for Investigation Potential Critical Coarse Sediment Yield Areas

mechanisms (such as 401 certifications, site design requirements, etc.) are generally sufficient to preserve the sediment transport functions of onsite channels.

However, projects that do not effectively avoid and bypass the CCSYAs mapped in Step 1 (i.e., Appendix H.1), will be required to specifically account for bypass of channel flows as part of the demonstration of no net impact outlined in Appendix H.4.

### H.3.3 De Minimis Upstream CCSYA

Applicants have an option to exclude de minimis upstream CCSYAs. De minimis upstream CCSYAs consist of coarse hillslope areas that are not significant contributors of bed sediment yield due to their small size, and are considered by the owner and the City Engineer as not practicable to bypass to the downstream waters of the state. In limited scenarios where all of the criteria below are satisfied, de minimis upstream CCSYAs may be omitted from consideration.

- De minimis upstream CCSYAs are not disturbed through the proposed project activities.
- De minimis upstream CCSYA is not part of an upstream drainage contributing more than 0.31 total acres to the project site.
- Multiple de minimis upstream CCSYAs cannot be adjacent to each other and hydraulically connected.
- The SWQMP must document the reason why each de minimis upstream CCSYA could not be bypassed to the downstream waters of the state.

The 0.31-acre (13,500 square feet) de minimis threshold was established using 0.25 cfs as the cut off peak flow for the 2-year, 24-hour event, rational method equation and the following assumptions:

- $C = 0.225$  (average runoff coefficient (C) for soil type A and B);
- Average 6-hour, 2-year storm depth = 1.5 inches;
- Time of concentration = 6 minutes; and
- 2-year peak intensity = 3.51 in/hr. (based on procedures from the County Hydrology Manual).

The strategies for sediment bypass do not mitigate for the reduction of CCSYA that have been replaced by development onsite but can only mitigate scenarios where development hinders movement of bed sediment through the project footprint. When preservation of existing channels and/or implementation of sediment bypass measures is not feasible and/or not implemented, the applicant must demonstrate no net impact to the receiving water via the measures presented in Appendix H.4.

## H.4 Step 4: Demonstrate No Net Impact

When impacts to CCSYAs cannot be avoided or effectively bypassed, the applicant must demonstrate that their project generates no net impact to the receiving water per the performance metrics identified herein.

- **Appendix H.4.1** provides background on the state of the current science for predicting hydromodification impacts due to reductions in sediment supply;
- **Appendix H.4.2** defines the management standard that will be the basis for evaluating whether “no net impact to the receiving water” is achieved;
- **Appendix H.4.3** identifies the type of mitigation measures (i.e., additional flow control, stream rehabilitation, and applicant proposed mitigation measures) that can be used to meet the management standard;
- **Appendix H.8** provides the methodology for calculation of Erosion Potential (Ep) and Sediment Supply Potential (Sp); and
- **Appendix H.9** provides fact sheets for implementation of the mitigation measures.

### H.4.1 Background

Channel form, by definition, is composed of bed and bank material as well as channel geometry (in plan, cross-section, and profile); however, the dominant forces typically controlling channel form are discharge and sediment supply (notably bed material) since a stream’s most basic function is to convey water and sediment (Knighton, 1998). The interaction between form and function is qualitatively described through Lane’s relationship in Equation H.4-1:

**Equation H.4.1: Lane’s Relationship**

$$Q_s \times d \propto Q_w \times S$$

Where:

$Q_s$  = Sediment discharge

$D$  = Particle diameter or size of sediment

$Q_w$  = Streamflow

$S$  = Stream slope

Lane’s relationship qualitatively states that the sediment load (size and volume of sediment), which is the first half of the relationship, is proportional to the stream power (volume of runoff and slope) which is represented by the second half of the relationship. The sediment discharge ( $Q_s$ ) in the relationship is the coarser part of sediment load, referred to as the “bed sediment”, since this is the part of the load which largely molds the bed formation (Lane, 1955). Lane’s relationship (Equation H.4.1) cannot be used for quantitative calculations since the proportionality is not necessarily linear.

For a stream at equilibrium, Lane’s relationship states that if one of the variables changes and the other variables do not change proportionately, then the stream channel is no longer in equilibrium.

## Appendix H: Guidance for Investigation Potential Critical Coarse Sediment Yield Areas

Sediment load and stream power can change considerably during and following new development, leading to changes in the equilibrium state of the receiving channel.

- Typically, sediment load increases during the construction period, due to the additional exposure of bare soil during the grading and construction process, and before landscaping vegetation has stabilized the soil. This is regulated through the construction-phase BMP requirements established by the Construction General Permit and/or the MS4 Permit.
- Following the construction period, sediment load typically decreases to below pre-development levels, as less sediment is available from areas that have been paved or stabilized by landscape vegetation. When this decrease is not regulated, the bed sediment supplied to the stream (first half of the relationship) is reduced and the sediment transport capacity (stream power) is increased due to increased flows and durations resulting from the addition of impervious areas (second half of the relationship). This may result in degradation of the stream system as illustrated in Figure H.4-1.

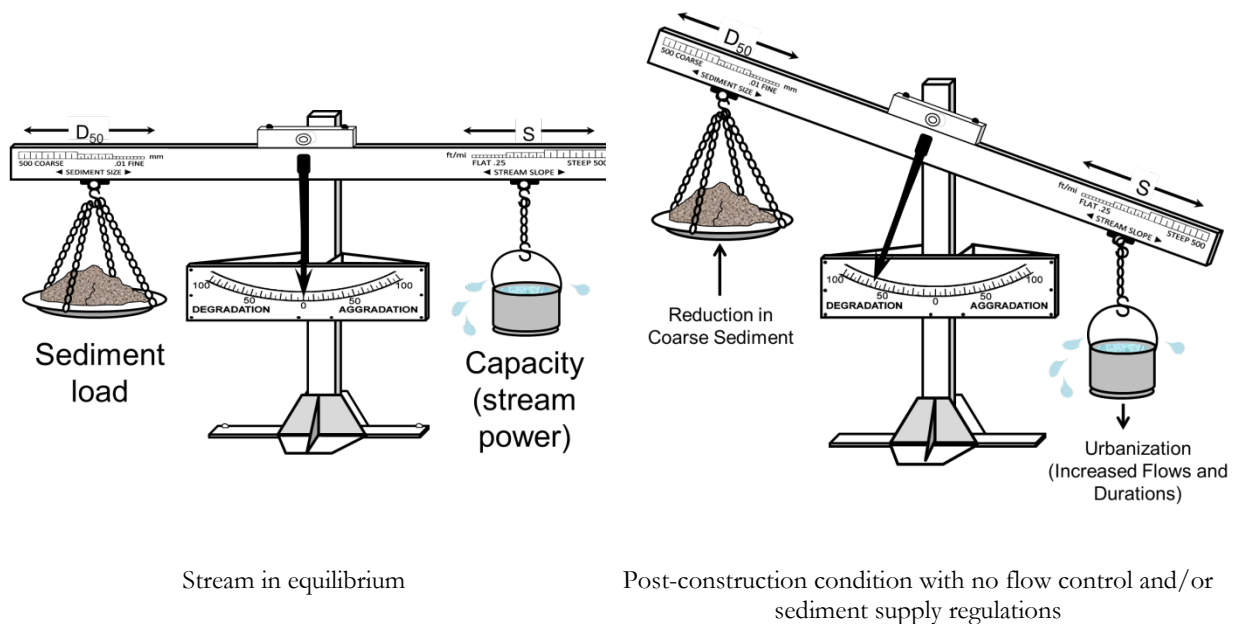

Schematics credit: SCCWRP

**Figure H.4-1 Illustration of Lane's Relationship**

Lane's relationship is useful for making qualitative predictions concerning channel impacts due to changes in runoff and/or sediment loads from the watershed. Although this qualitative assessment is useful for understanding how the watershed responds to development, quantitative predictions are valuable for determining the magnitude of response and they can inform the identification of locations where the greatest management attention should be invested.

Lane's relationship can be supplemented by the use of quantitative predictions which allow the evaluation of the stream under changing conditions. Quantitative predictions will include bed



## Appendix H: Guidance for Investigation Potential Critical Coarse Sediment Yield Areas

sediment supply calculations for the first half of the Lane relationship, and bed sediment transport capacity calculations for the second half of the Lane relationship. Imbalances between the bed sediment supply rate and transport capacity determines the rate of sediment deposition or erosion in the channel and the associated channel change (Wilcock et al., 2009).

The common practice is to use the Erosion Potential ( $E_p$ ) metric to evaluate the changes in sediment transport capacity and the Sediment Supply Potential ( $S_p$ ) metric to evaluate the changes in bed sediment supply for susceptible receiving channels of concern. In regards to  $E_p$  metric,

- SCCWRP Technical Report 667 (SCCWRP, 2012) states:  
“The underlying premise of the erosion potential approach advances the concept of flow duration control by addressing in-stream processes related to sediment transport. An erosion potential calculation combines flow parameters with stream geometry to assess long term (decadal) changes in the sediment transport capacity. The cumulative distribution of shear stress, specific stream power and sediment transport capacity across the entire range of relevant flows can be calculated and expressed using an erosion potential metric,  $E_p$ .”
- SCCWRP Technical Report 753 (SCCWRP, 2013) states the following based on review of field measurements from 61 sites in Southern California:  
“Results indicate that channel enlargement is highly dependent on the ratio of post- to pre-urban sediment-transport capacity over cumulative duration simulations of 25 years (load ratio, a.k.a. erosion potential), which explained nearly 60% of the variance.”

For the purposes of implementing mitigation measures within the MS4-permitted region of the County of San Diego: this manual defines  $E_p$  as the ratio of post-project/pre-development (natural) long-term transport capacity or work; and  $S_p$  as the ratio of post-project/pre-project (existing) long-term bed sediment supply. Guidance for calculating  $E_p$  and  $S_p$  are provided in Appendix H.8.

### H.4.2 Management Standard

This guidance defines a sediment supply management standard through which no net impact to receiving water can be quantitatively indicated. This management standard is demonstrated through the Net Impact Index (NII), a dimensionless index that must be used by the applicant to evaluate if there is, or is not, a net impact to the receiving water. NII is defined in this manual as the ratio of  $E_p$  to  $S_p$ . Mitigation measures shall be designed to meet the NII management standard shown in Equation H.4.2 to achieve no net impact to the receiving water. The NII management standard is based on Lane’s relationship ( $E_p$  is directly proportional to  $S_p$ ) and an allowance of 10% (based on Section H.4.2.1). This represents the most appropriate current understanding of how to quantitatively account for sediment supply changes without replacing bed sediment sources (Palhegyi and Rathfelder, 2007 and Parra, 2015).

Equation H.4-2: Net Impact Index

$$NII = \frac{Ep}{Sp} \leq 1.1$$

Where:

NII = Net Impact Index

Ep = Erosion Potential

Sp = Sediment Supply Potential

If  $NII \leq 1.1$ , then the project produces no net impact to the receiving water in terms of coarse sediment yield, and no further analysis is required. If  $NII > 1.1$ , then the project generates an impact on the receiving water and the project is required to implement mitigation measures defined in Appendix H.4.3 such that the NII is reduced to a compliant value ( $NII \leq 1.1$ ).

**H.4.2.1 Allowance to the NII Management Standard**

This manual establishes the NII defined in Appendix H.4.2 as the management standard for coarse sediment supply. The 10% allowance to the management standard is supported by the following research studies or projects:

- The authors of the USACE report for channel design (USACE, 2001) state that, “achieving an optimum Capacity-Supply Ratio, within 10 percent of unity, should ensure dynamic stability while allowing the river itself to recover some of the fluvial detail that cannot be engineered.”
- The authors of SCCWRP Technical Report 605 (SCCWRP, 2010), “anticipate that changes of less than 10% in either driver [discharge or sediment flux] are unlikely to instigate, on their own, significant channel changes. This value is a conservative estimate of the year-to-year variability in either discharge or sediment flux that can be accommodated by a channel system in a state of dynamic equilibrium.”
- Sediment transport and supply measurements and calculations are inherently inexact. Discrepancies of up to 10% should not be a source of concern (PCR et al., 2002).

H.4.3 Types of Mitigation Measures

The following section discusses mitigation measures that may be used by the applicant to meet the NII management standard defined in Appendix H.4.2. These include:

- Additional Flow Control;
- Stream Rehabilitation; and
- Applicant Proposed Mitigation Measures

Appendix H.9 provides additional guidance for implementation of these mitigation measures.

### H.4.3.1 Additional Flow Control

One option for managing bed sediment supply reductions is to provide additional detention and retention of site runoff to compensate for the reduction of bed sediment supply. This measure requires increasing flow attenuation by adding storage volume in structural BMPs. This management option accounts for changes in hydrology, channel geometry, and bed/bank material, but not sediment supply. For example, if there is a 30% reduction in bed-load due to proposed urbanization, then the sediment supply potential ( $S_p$ ) equals 0.7. Assuming the appropriate range is +10%, hydromodification controls can be sized and situated such that the post-project effective in-stream work is lowered to less than 77% of the baseline pre-development condition.

Structural BMPs designed for hydromodification control utilize the following two basic principles:

- Detain runoff and release it in a controlled way that either mimics pre-development in-stream sediment transport capacity, mimics flow durations, or reduces flow durations to account for a reduction in bed sediment supply.
- Manage excess runoff volumes through one or more of the following pathways: (1) infiltration; (2) evapotranspiration; (3) storage and use; (4) discharge at a rate below the critical low flowrate; or (5) discharge downstream to a receiving water that is not susceptible to hydromodification impacts.

If desired, structural BMPs can be designed to support flood control and LID objectives in addition to hydromodification control. To the maximum extent possible, structural BMPs should be designed to receive flows from developed areas only. This facilitates design optimization as well as avoiding intercepting coarse sediments from open spaces that should ideally be passed through to the stream channel.

A fact sheet for additional flow control is provided in Appendix H.9.1.

### H.4.3.2 Stream Rehabilitation

Hydromodification control can be achieved by stream rehabilitation projects including: drop structures, grade control structures, bed and bank reinforcement, increased channel sinuosity or meandering, increased channel width, and flow diversion. The objective of these in-stream controls, or stream restoration measures, is to reduce or maintain the overall Erosion Potential ( $E_p$ ) of the receiving channel by modifying its hydraulic properties and/or bed/bank material resistance without fully replacing sediment supply or controlling increases in runoff. Stream rehabilitation is only an option where the receiving channel of concern is already impacted by erosive flows and shows evidence of excessive sediment, erosion, deposition, or is a hardened channel.

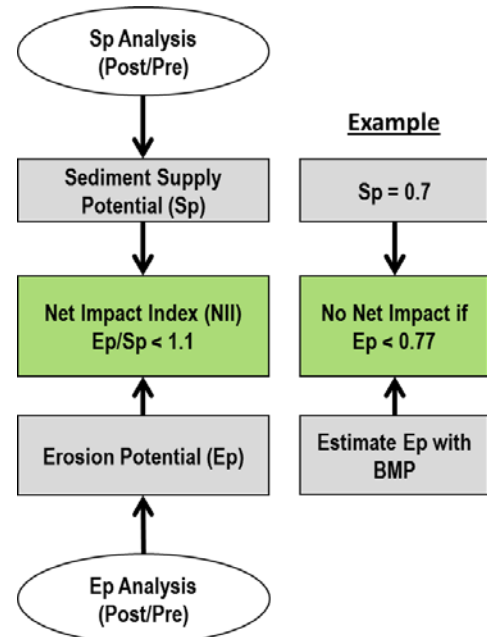

## **Appendix H: Guidance for Investigation Potential Critical Coarse Sediment Yield Areas**

Stream rehabilitation projects are subject to the permitting requirements of the resource agencies. Stream rehabilitation projects may require the following permits:

- California Department of Fish and Wildlife – 1602 Streambed Alteration Agreement.
- US Fish and Wildlife Service – Authorization under the Endangered Species Act.
- US Army Corps of Engineers – Clean Water Act Section 404 Permit.
- Regional Water Quality Control Board – Clean Water Act Section 401 Water Quality Certification.
- Local Grading Permit

A fact sheet for stream rehabilitation is provided in Appendix H.9.2.

### **H.4.3.3 Applicant Proposed Mitigation Measures**

The applicant may propose a mitigation measure not identified in this manual if it will achieve no net impact to the receiving water. Additional analysis may be requested by the City Engineer prior to approval of the mitigation measure to substantiate the finding of no net impact to the receiving water.

## Appendix H: Guidance for Investigation Potential Critical Coarse Sediment Yield Areas

### H.5 References

- American Society of Civil Engineers and Water Environment Federation. 1992. Design and Construction of Urban Stormwater Management Systems. ASCE Manual No. 77, WEF Manual No. 20, Alexandria, VA.
- ASCE, 1970. Design and construction of sanitary and storm sewers, ASCE Manual of Engineering Practice No. 37, WPCF Manual of Practice No. 9. Prepared by the Joint Committee of the American Society of Civil Engineers and the Water Pollution Control Federation
- Chow, V.T. 1959. Open-Channel Hydraulics. McGraw-Hill Book Company.
- Fischenich, C. 2001. “Stability Thresholds for Stream Restoration Materials.” EMRRP Technical Notes Collection (ERDC TN-EMRRP-SR-29), U.S. Army Engineer Research and Development Center, Vicksburg, MS.
- Hawley, R.J., and Bledsoe, B.P. 2011. “How do flow peaks and durations change in suburbanizing semi-arid watersheds? A southern California Study,” Journal of Hydrology, Elsevier, Vol 405, pp 69-82.
- Knighton D., 1998. Fluvial Forms and Processes: A New Perspective. Arnold Publishers.
- Lane, E.W. 1955. The Importance of Fluvial Morphology in Hydraulic Engineering. American Society of Civil Engineers. Proceedings, Vol. 81, Paper No. 745.
- Los Angeles Regional Water Quality Control Board (LARWQCB). 2012. Los Angeles County MS4 Permit (Order No. R4-2012-0175).
- National Resource Conservation Service (NRCS), 2007. National Engineering Handbook Part 654 - Stream Restoration Design.
- Palhegyi, G.E. and Rathfelder, K. 2007. “Applying the Erosion Potential Methodology to Natural Channel Design Procedures in Southern California”. Presented at CASQA, Sept 2007, Orange County, California.
- Parra, L.A., 2015. Addressing Critical Coarse Sediment Impact by Defining Dimensionless Indexes of Coarse Sediment Production, Transport and Net Impact.
- Parra, L.A., 2016. Link between Flow Duration Curve and Erosion Work – Expanded.
- PCR Services Corporation, Philip Williams and Associates, and Balance Hydrologics, Inc. 2002. Baseline Geomorphic and Hydrologic Conditions Report, Ranch Mission Viejo: Portions of the San Juan and Western San Mateo Watersheds, prepared for Rancho Mission Viejo.
- Renard, K.G., G.R. Foster, G.A. Weesies, D.K. McCool and D.C. Yoder, 1997. Predicting Soil Erosion by Water. A guide to conservation planning with Revised Universal Soil Loss Equation (RUSLE). U.S. Department of Agriculture, Agriculture Handbook No. 703.
- San Diego, County of. 2011. Final Hydromodification Management Plan.
- Santa Clara Valley Urban Runoff Pollution Prevention Program (SCVURPPP). 2005. Hydromodification Management Plan. April 21, 2005.

## Appendix H: Guidance for Investigation Potential Critical Coarse Sediment Yield Areas

- Shields, F.D. 1996. Hydraulic and Hydrologic Stability In: A Brooks and FD Shields (Eds.), River Channel Restoration, 23-74.
- Shields, F.D., A. Brooks and J. Haltiner. 1999. Geomorphological Approaches to Incised Stream Channel Restoration in the United States and Europe. In: SE Darby and A Simon (Eds.) Incised River Channels.
- Southern California Coastal Water Research Project (SCCWRP), 2008. Stream Channel Classification and Mapping Systems: Implications for Assessing Susceptibility to Hydromodification Effects in Southern California, Technical Report 562.
- Southern California Coastal Water Research Project (SCCWRP), 2005. Effect of Increases in Peak Flows and Impervious on the Morphology of Southern California Streams, Technical Report 450.
- Southern California Coastal Water Research Project (SCCWRP), 2010. Hydromodification Screening Tools: GIS-based catchment analyses of potential changes in runoff and sediment discharge. Technical Report 605.
- Southern California Coastal Water Research Project (SCCWRP), 2010a. Hydromodification Screening Tools: Field Manual for Assessing Channel Susceptibility. Technical Report 606.
- Southern California Coastal Water Research Project (SCCWRP), 2012. Hydromodification Assessment and Management in California. Technical Report 667.
- Southern California Coastal Water Research Project (SCCWRP), 2013. Modeling and Managing Hydromodification Effects: summary of Available Tools and Decision-Making Approach. Technical Report 753.
- USACE, 2001. Channel Restoration Design for Meandering Rivers. US Army Corps of Engineers, Final Report, ERDC/CHL CR-01-1. Prepared by Soar, P.J., and Thorne, C.R.
- USDA, 1974. Present Sediment Yield Rates for Western United States. U. S. Department of Agriculture Soil Conservation Service.
- Wilcock, P., J. Pitlick, and Y. Cui. 2009. Sediment Transport Primer Estimating Bed-Material Transport in Gravel-bed Rivers. USDA General Technical Report, RMRS-GTR-226.

### H.5.1 Terms of Reference

The guidance described in Appendix H of this manual was developed by Geosyntec Consultants (Geosyntec) on behalf of the County of San Diego and the City of San Diego. Appendix H was specifically developed to provide PDP applicants guidance to meet the MS4 Permit Provision E.3.c.(2)(b) within the MS4-permitted region within the San Diego County. This guidance is not intended to be used for purposes, other than to meet this MS4 Permit requirement.

The guidance was developed with input from a Technical Advisory Committee (TAC) members through a series of meetings conducted in January 2016. The TAC input resulted in a streamlined guidance enhanced to provide applicants with simplified methods to determine impacts to coarse sediment delivery based on complex scientific principles. TAC participants included:

## Appendix H: Guidance for Investigation Potential Critical Coarse Sediment Yield Areas

Bill Woolsey | Brian Haines | Charles Mohrlock | Chris Wolff | Dave Hammar | David Garcia | Emir Williams | Eric Mosolgo | Eric Stein | Erica Ryan | Howard Chang | Jon VanRhyn | Jonard Talamayan | Judd Goodman | Ken Susilo | Laura Henry | Luis Parra | Max Dugan | Rich Lucera | Sheri McPherson | Sumer Hasenin | Trevor Alsop | Venkat Gummadi | Wayne Chiu |

## Appendix H: Guidance for Investigation Potential Critical Coarse Sediment Yield Areas

### H.6 PCCSYAs: Regional WMAA Maps

PCCSYAs identified by the Regional WMAA were delineated using regional datasets for elevation, land cover, and geology. The methodology used to identify PCCSYAs from these datasets is based on Geomorphic Landscape Unit (GLU) methodology presented in the SCCWRP Technical Report 605. GLUs characterize the magnitude of sediment production from areas through three factors judged to exert the greatest influence on the variability on sediment-production rates: geology types, hillslope gradient, and land cover. The Regional WMAA document and the GIS layers for the map can be found on the Project Clean Water website at the following address:

[http://www.projectcleanwater.org/index.php?option=com\\_content&view=article&id=248&Itemid=219](http://www.projectcleanwater.org/index.php?option=com_content&view=article&id=248&Itemid=219)

The regional-level mapping is based on the following sources:

Dataset	Source	Year	Description
<b>Elevation</b>	USGS	2013	1/3 <sup>rd</sup> Arc Second (~10 meter cells) digital elevation model for San Diego County
<b>Land Cover</b>	SanGIS	2013	Ecology-Vegetation layer for San Diego County downloaded from SanGIS
<b>Geology</b>	Kennedy, M.P., and Tan, S.S.	2002	Geologic Map of the Oceanside 30'x60' Quadrangle, California, California Geological Survey, Regional Geologic Map No. 2, 1:100,000 scale.
	Kennedy, M.P., and Tan, S.S.	2008	Geologic Map of the San Diego 30'x60' Quadrangle, California, California Geological Survey, Regional Geologic Map No. 3, 1:100,000 scale.
	Todd, V.R.	2004	Preliminary Geologic Map of the El Cajon 30'x60' Quadrangle, Southern California, United States Geological Survey, Southern California Areal Mapping Project, Open File Report 2004-1361, 1:100,000 scale.
	Jennings et al.	2010	"Geologic Map of California," California Geological Survey, Map No. 2 – Geologic Map of California, 1:750,000 scale

The regional data set is a function of the inherent data resolution of the macro-level data sets and may not conform to all site conditions, or does not reflect changes to particular areas that have occurred since the underlying data was developed. This means slopes, geology, or land cover at the project site can be mischaracterized in the regional data set. If an applicant feels the Regional WMAA analysis inaccurately mapped their project area, they may elect to perform a site-specific GLU analysis based on data collected from project-level investigations to refine the mapping as outlined below.

The following PCCSYAs may be removed from the mapping without performing the full GLU analysis described in Appendix H.6.1 a) areas under 10% slope, b) paved areas.



## Appendix H: Guidance for Investigation Potential Critical Coarse Sediment Yield Areas

### H.6.1 Site-Specific GLU Analysis

In order to perform a site-specific GLU analysis the applicant must first delineate the project boundary and any areas draining through the project boundary. The applicant must then determine appropriate slopes, geology, and land cover categories for this area as identified below (the GLU analysis must be conducted for the entire project boundary and areas draining through it).

There are four slope categories in the GLU analysis. Category numbers shown (1 to 4) were assigned for the purpose of GIS processing.

- 0% to 10% (1)
- 10% to 20% (2)
- 20% to 40% (3)
- >40% (4)

There are seven geology categories in the GLU analysis:

- Coarse bedrock (CB)
- Coarse sedimentary impermeable (CSI)
- Coarse sedimentary permeable (CSP)
- Fine bedrock (FB)
- Fine sedimentary impermeable (FSI)
- Fine sedimentary permeable (FSP)
- Other (O)

There are six land cover categories in the GLU analysis:

- Agriculture/grass
- Forest
- Developed
- Scrub/shrub
- Other
- Unknown

Project site slopes shall be classified into the categories based on project-level topography. Project site geology may be determined from geologic maps (may be the same as regional-level information) or classified in the field by a qualified geologist. Table H-1.1 provides information to classify geologic map units into each geology category. Project site land cover shall be determined from aerial

## Appendix H: Guidance for Investigation Potential Critical Coarse Sediment Yield Areas

photography and/or field visit. For reference, Table H-1.2 provides information to classify land cover categories from the SanGIS Ecology-Vegetation data set into land cover categories. The civil engineer shall not rely on the SanGIS Ecology-Vegetation data set to identify actual land cover at the project site (for project-level investigation land cover must be confirmed by aerial photo or field visit). Intersect the geologic categories, land cover categories, and slope categories within the project boundary to create GLUs. The GLUs listed in Table H-1.3 (also shown in Table 6-1) are considered to be potential critical coarse sediment yield areas. Note the GLU nomenclature is presented in the following format: Geology – Land Cover – Slope Category (e.g., "CB-Agricultural/Grass-3" for a GLU consisting of coarse bedrock geology, agricultural/grass land cover, and 20% to 40% slope).

GLUs are created by intersecting the geologic categories, land cover categories, and slope categories. This is a similar procedure to intersecting land uses with soil types to determine runoff coefficients or runoff curve numbers for hydrologic studies, but there are three categories to consider for the GLU analysis (slope, geology, and land cover), and the GLUs are not to be composited into a single GLU. When GLUs have been created, determine whether any of the GLUs listed in Table H.6-3 are found within the project boundary. The GLUs listed in Table H.6-3 are considered to be PCCSYAs.

If none of the GLUs listed in Table H.6-3 are present within the project boundary and area draining through the project boundary, no measures for protection of critical coarse sediment yield areas are necessary. If one or more GLUs listed in Table H.6-3 are present within the project boundary, they shall be considered critical coarse sediment yield areas. Complete Worksheet H.6-1 to document verification of GLUs.

**Table H.6-1: Geologic Grouping for Different Map Units**

Map Unit	Map Name	Anticipated Grain size of Weathered Material	Bedrock or Sedimentary	Impermeable / Permeable	Geology Grouping
<b>gr-m</b>	Jennings; CA	Coarse	Bedrock	Impermeable	CB
<b>grMz</b>	Jennings; CA	Coarse	Bedrock	Impermeable	CB
<b>Jcr</b>	El Cajon 30' x 60'	Coarse	Bedrock	Impermeable	CB
<b>Jhc</b>	El Cajon 30' x 60'	Coarse	Bedrock	Impermeable	CB
<b>Jsp</b>	El Cajon 30' x 60'	Coarse	Bedrock	Impermeable	CB
<b>Ka</b>	El Cajon 30' x 60'	Coarse	Bedrock	Impermeable	CB
<b>Kbm</b>	Oceanside 30' x 60'	Coarse	Bedrock	Impermeable	CB
<b>Kbp</b>	Oceanside 30' x 60'	Coarse	Bedrock	Impermeable	CB
<b>Kcc</b>	Oceanside 30' x 60'	Coarse	Bedrock	Impermeable	CB
<b>Kcg</b>	Oceanside 30' x 60'	Coarse	Bedrock	Impermeable	CB
<b>Kcm</b>	El Cajon 30' x 60'	Coarse	Bedrock	Impermeable	CB
<b>Kcp</b>	El Cajon 30' x 60'	Coarse	Bedrock	Impermeable	CB
<b>Kd</b>	San Diego & Oceanside 30' x 60'	Coarse	Bedrock	Impermeable	CB
<b>Kdl</b>	Oceanside 30' x 60'	Coarse	Bedrock	Impermeable	CB
<b>Kg</b>	Oceanside 30' x 60'	Coarse	Bedrock	Impermeable	CB
<b>Kgbf</b>	Oceanside 30' x 60'	Coarse	Bedrock	Impermeable	CB

**Appendix H: Guidance for Investigation Potential Critical Coarse Sediment Yield Areas**

Map Unit	Map Name	Anticipated Grain size of Weathered Material	Bedrock or Sedimentary	Impermeable / Permeable	Geology Grouping
<b>Kgd</b>	San Diego & Oceanside 30' x 60'	Coarse	Bedrock	Impermeable	CB
<b>Kgdf</b>	Oceanside 30' x 60'	Coarse	Bedrock	Impermeable	CB
<b>Kgh</b>	San Diego 30' x 60'	Coarse	Bedrock	Impermeable	CB
<b>Kgm</b>	El Cajon 30' x 60'	Coarse	Bedrock	Impermeable	CB
<b>Kgm1</b>	El Cajon 30' x 60'	Coarse	Bedrock	Impermeable	CB
<b>Kgm2</b>	El Cajon 30' x 60'	Coarse	Bedrock	Impermeable	CB
<b>Kgm3</b>	El Cajon 30' x 60'	Coarse	Bedrock	Impermeable	CB
<b>Kgm4</b>	El Cajon 30' x 60'	Coarse	Bedrock	Impermeable	CB
<b>Kgp</b>	Oceanside 30' x 60'	Coarse	Bedrock	Impermeable	CB
<b>Kgr</b>	El Cajon 30' x 60'	Coarse	Bedrock	Impermeable	CB
<b>Kgu</b>	San Diego 30' x 60'	Coarse	Bedrock	Impermeable	CB
<b>Khg</b>	Oceanside 30' x 60'	Coarse	Bedrock	Impermeable	CB
<b>Ki</b>	Oceanside 30' x 60'	Coarse	Bedrock	Impermeable	CB
<b>Kis</b>	Oceanside 30' x 60'	Coarse	Bedrock	Impermeable	CB
<b>Kjd</b>	Oceanside 30' x 60'	Coarse	Bedrock	Impermeable	CB
<b>KJem</b>	El Cajon 30' x 60'	Coarse	Bedrock	Impermeable	CB
<b>KJld</b>	El Cajon 30' x 60'	Coarse	Bedrock	Impermeable	CB
<b>Kjv</b>	El Cajon 30' x 60'	Coarse	Bedrock	Impermeable	CB
<b>Klb</b>	El Cajon 30' x 60'	Coarse	Bedrock	Impermeable	CB
<b>Klh</b>	Oceanside 30' x 60'	Coarse	Bedrock	Impermeable	CB
<b>Klp</b>	El Cajon 30' x 60'	Coarse	Bedrock	Impermeable	CB
<b>Km</b>	Oceanside 30' x 60'	Coarse	Bedrock	Impermeable	CB
<b>Kmg</b>	Oceanside 30' x 60'	Coarse	Bedrock	Impermeable	CB
<b>Kmgp</b>	El Cajon 30' x 60'	Coarse	Bedrock	Impermeable	CB
<b>Kmm</b>	Oceanside 30' x 60'	Coarse	Bedrock	Impermeable	CB
<b>Kpa</b>	Oceanside 30' x 60'	Coarse	Bedrock	Impermeable	CB
<b>Kpv</b>	El Cajon 30' x 60'	Coarse	Bedrock	Impermeable	CB
<b>Kqbd</b>	Oceanside 30' x 60'	Coarse	Bedrock	Impermeable	CB
<b>Kr</b>	Oceanside 30' x 60'	Coarse	Bedrock	Impermeable	CB
<b>Krm</b>	Oceanside 30' x 60'	Coarse	Bedrock	Impermeable	CB
<b>Krr</b>	Oceanside 30' x 60'	Coarse	Bedrock	Impermeable	CB
<b>Kt</b>	San Diego & Oceanside 30' x 60'	Coarse	Bedrock	Impermeable	CB
<b>Ktr</b>	Oceanside 30' x 60'	Coarse	Bedrock	Impermeable	CB
<b>Kvc</b>	Oceanside 30' x 60'	Coarse	Bedrock	Impermeable	CB
<b>Kwm</b>	Oceanside 30' x 60'	Coarse	Bedrock	Impermeable	CB
<b>Kwp</b>	Oceanside 30' x 60'	Coarse	Bedrock	Impermeable	CB
<b>Kwsr</b>	Oceanside 30' x 60'	Coarse	Bedrock	Impermeable	CB
<b>m</b>	Jennings; CA	Coarse	Bedrock	Impermeable	CB
<b>Mzd</b>	Oceanside 30' x 60'	Coarse	Bedrock	Impermeable	CB
<b>Mzg</b>	Oceanside 30' x 60'	Coarse	Bedrock	Impermeable	CB
<b>Mzq</b>	Oceanside 30' x 60'	Coarse	Bedrock	Impermeable	CB

**Appendix H: Guidance for Investigation Potential Critical Coarse Sediment Yield Areas**

Map Unit	Map Name	Anticipated Grain size of Weathered Material	Bedrock or Sedimentary	Impermeable / Permeable	Geology Grouping
<b>Mzs</b>	Oceanside 30' x 60'	Coarse	Bedrock	Impermeable	CB
<b>sch</b>	Jennings; CA	Coarse	Bedrock	Impermeable	CB
<b>Kp</b>	San Diego & Oceanside 30' x 60'	Coarse	Bedrock	Impermeable	CB
<b>Ql</b>	El Cajon 30' x 60'	Coarse	Sedimentary	Impermeable	CSI
<b>QTf</b>	El Cajon 30' x 60'	Coarse	Sedimentary	Impermeable	CSI
<b>Ec</b>	Jennings; CA	Coarse	Sedimentary	Impermeable	CSI
<b>K</b>	Jennings; CA	Coarse	Sedimentary	Impermeable	CSI
<b>Kccg</b>	San Diego 30' x 60'	Coarse	Sedimentary	Impermeable	CSI
<b>Kcs</b>	San Diego 30' x 60'	Coarse	Sedimentary	Impermeable	CSI
<b>Kl</b>	San Diego, Oceanside & El Cajon 30' x 60'	Coarse	Sedimentary	Impermeable	CSI
<b>Ku</b>	Jennings; CA	Coarse	Sedimentary	Impermeable	CSI
<b>Qvof</b>	Oceanside 30' x 60'	Coarse	Sedimentary	Impermeable	CSI
<b>Qvop8a</b>	San Diego 30' x 60'	Coarse	Sedimentary	Impermeable	CSI
<b>Qvop9a</b>	San Diego 30' x 60'	Coarse	Sedimentary	Impermeable	CSI
<b>Tmsc</b>	San Diego 30' x 60'	Coarse	Sedimentary	Impermeable	CSI
<b>Tmss</b>	San Diego 30' x 60'	Coarse	Sedimentary	Impermeable	CSI
<b>Tp</b>	San Diego & El Cajon 30' x 60'	Coarse	Sedimentary	Impermeable	CSI
<b>Tpm</b>	San Diego 30' x 60'	Coarse	Sedimentary	Impermeable	CSI
<b>Tsc</b>	San Diego 30' x 60'	Coarse	Sedimentary	Impermeable	CSI
<b>Tscu</b>	San Diego 30' x 60'	Coarse	Sedimentary	Impermeable	CSI
<b>Tsd</b>	San Diego & El Cajon 30' x 60'	Coarse	Sedimentary	Impermeable	CSI
<b>Tsdcg</b>	San Diego 30' x 60'	Coarse	Sedimentary	Impermeable	CSI
<b>Tsdss</b>	San Diego 30' x 60'	Coarse	Sedimentary	Impermeable	CSI
<b>Tsm</b>	Oceanside 30' x 60'	Coarse	Sedimentary	Impermeable	CSI
<b>Tso</b>	Oceanside 30' x 60'	Coarse	Sedimentary	Impermeable	CSI
<b>Tst</b>	San Diego, Oceanside & El Cajon 30' x 60'	Coarse	Sedimentary	Impermeable	CSI
<b>Tt</b>	San Diego & Oceanside 30' x 60'	Coarse	Sedimentary	Impermeable	CSI
<b>Tta</b>	Oceanside 30' x 60'	Coarse	Sedimentary	Impermeable	CSI
<b>Tmv</b>	San Diego, Oceanside & El Cajon 30' x 60'	Coarse	Sedimentary	Impermeable	CSI
<b>Tsi</b>	Oceanside 30' x 60'	Coarse	Sedimentary	Impermeable	CSI
<b>Qvoa</b>	San Diego & Oceanside 30' x 60'	Coarse	Sedimentary	Impermeable	CSI
<b>Qvoa11</b>	Oceanside 30' x 60'	Coarse	Sedimentary	Impermeable	CSI
<b>Qvoa12</b>	Oceanside 30' x 60'	Coarse	Sedimentary	Impermeable	CSI

**Appendix H: Guidance for Investigation Potential Critical Coarse Sediment Yield Areas**

Map Unit	Map Name	Anticipated Grain size of Weathered Material	Bedrock or Sedimentary	Impermeable / Permeable	Geology Grouping
Qvoa13	Oceanside 30' x 60'	Coarse	Sedimentary	Impermeable	CSI
Qvoc	Oceanside 30' x 60'	Coarse	Sedimentary	Impermeable	CSI
Qvop	San Diego & Oceanside 30' x 60'	Coarse	Sedimentary	Impermeable	CSI
Qvop1	San Diego & Oceanside 30' x 60'	Coarse	Sedimentary	Impermeable	CSI
Qvop10	San Diego & Oceanside 30' x 60'	Coarse	Sedimentary	Impermeable	CSI
Qvop10a	San Diego 30' x 60'	Coarse	Sedimentary	Impermeable	CSI
Qvop11	San Diego & Oceanside 30' x 60'	Coarse	Sedimentary	Impermeable	CSI
Qvop11a	San Diego 30' x 60'	Coarse	Sedimentary	Impermeable	CSI
Qvop12	San Diego & Oceanside 30' x 60'	Coarse	Sedimentary	Impermeable	CSI
Qvop13	San Diego & Oceanside 30' x 60'	Coarse	Sedimentary	Impermeable	CSI
Qvop2	San Diego & Oceanside 30' x 60'	Coarse	Sedimentary	Impermeable	CSI
Qvop3	San Diego & Oceanside 30' x 60'	Coarse	Sedimentary	Impermeable	CSI
Qvop4	San Diego & Oceanside 30' x 60'	Coarse	Sedimentary	Impermeable	CSI
Qvop5	San Diego & Oceanside 30' x 60'	Coarse	Sedimentary	Impermeable	CSI
Qvop6	San Diego 30' x 60'	Coarse	Sedimentary	Impermeable	CSI
Qvop7	San Diego & Oceanside 30' x 60'	Coarse	Sedimentary	Impermeable	CSI
Qvop8	San Diego & Oceanside 30' x 60'	Coarse	Sedimentary	Impermeable	CSI
Qvop9	San Diego 30' x 60'	Coarse	Sedimentary	Impermeable	CSI
Tsa	Oceanside 30' x 60'	Coarse	Sedimentary	Impermeable	CSI
Qof	Oceanside 30' x 60'	Coarse	Sedimentary	Permeable	CSP
Qof1	Oceanside 30' x 60'	Coarse	Sedimentary	Permeable	CSP
Qof2	Oceanside 30' x 60'	Coarse	Sedimentary	Permeable	CSP
Q	Jennings; CA	Coarse	Sedimentary	Permeable	CSP
Qa	Oceanside 30' x 60'	Coarse	Sedimentary	Permeable	CSP
Qd	Oceanside 30' x 60'	Coarse	Sedimentary	Permeable	CSP
Qf	Oceanside 30' x 60'	Coarse	Sedimentary	Permeable	CSP
Qmb	San Diego & Oceanside 30' x 60'	Coarse	Sedimentary	Permeable	CSP
Qop	San Diego & Oceanside 30' x 60'	Coarse	Sedimentary	Permeable	CSP
Qw	San Diego & Oceanside 30' x 60'	Coarse	Sedimentary	Permeable	CSP

**Appendix H: Guidance for Investigation Potential Critical Coarse Sediment Yield Areas**

Map Unit	Map Name	Anticipated Grain size of Weathered Material	Bedrock or Sedimentary	Impermeable / Permeable	Geology Grouping
<b>Qyf</b>	Oceanside 30' x 60'	Coarse	Sedimentary	Permeable	CSP
<b>Qt</b>	El Cajon 30' x 60'	Coarse	Sedimentary	Permeable	CSP
<b>Qoa1-2</b>	Oceanside 30' x 60'	Coarse	Sedimentary	Permeable	CSP
<b>Qoa2-6</b>	Oceanside 30' x 60'	Coarse	Sedimentary	Permeable	CSP
<b>Qoa5</b>	Oceanside 30' x 60'	Coarse	Sedimentary	Permeable	CSP
<b>Qoa6</b>	Oceanside 30' x 60'	Coarse	Sedimentary	Permeable	CSP
<b>Qoa7</b>	Oceanside 30' x 60'	Coarse	Sedimentary	Permeable	CSP
<b>Qoc</b>	Oceanside 30' x 60'	Coarse	Sedimentary	Permeable	CSP
<b>Qop1</b>	Oceanside 30' x 60'	Coarse	Sedimentary	Permeable	CSP
<b>Qc</b>	El Cajon 30' x 60'	Coarse	Sedimentary	Permeable	CSP
<b>Qu</b>	El Cajon 30' x 60'	Coarse	Sedimentary	Permeable	CSP
<b>Qoa</b>	San Diego, Oceanside & El Cajon 30' x 60'	Coarse	Sedimentary	Permeable	CSP
<b>Qop2-4</b>	San Diego 30' x 60'	Coarse	Sedimentary	Permeable	CSP
<b>Qop3</b>	Oceanside 30' x 60'	Coarse	Sedimentary	Permeable	CSP
<b>Qop4</b>	Oceanside 30' x 60'	Coarse	Sedimentary	Permeable	CSP
<b>Qop6</b>	San Diego & Oceanside 30' x 60'	Coarse	Sedimentary	Permeable	CSP
<b>Qop7</b>	San Diego & Oceanside 30' x 60'	Coarse	Sedimentary	Permeable	CSP
<b>Qya</b>	San Diego, Oceanside & El Cajon 30' x 60'	Coarse	Sedimentary	Permeable	CSP
<b>Qyc</b>	San Diego & Oceanside 30' x 60'	Coarse	Sedimentary	Permeable	CSP
<b>Mzu</b>	San Diego & Oceanside 30' x 60'	Fine	Bedrock	Impermeable	FB
<b>gb</b>	Jennings; CA	Fine	Bedrock	Impermeable	FB
<b>JTRm</b>	El Cajon 30' x 60'	Fine	Bedrock	Impermeable	FB
<b>Kat</b>	Oceanside 30' x 60'	Fine	Bedrock	Impermeable	FB
<b>Kc</b>	El Cajon 30' x 60'	Fine	Bedrock	Impermeable	FB
<b>Kgb</b>	Oceanside 30' x 60'	Fine	Bedrock	Impermeable	FB
<b>Kjvs</b>	El Cajon 30' x 60'	Fine	Bedrock	Impermeable	FB
<b>Kmv</b>	El Cajon 30' x 60'	Fine	Bedrock	Impermeable	FB
<b>Ksp</b>	El Cajon 30' x 60'	Fine	Bedrock	Impermeable	FB
<b>Kvsp</b>	Oceanside 30' x 60'	Fine	Bedrock	Impermeable	FB
<b>Kwmt</b>	Oceanside 30' x 60'	Fine	Bedrock	Impermeable	FB
<b>Qv</b>	Jennings; CA	Fine	Bedrock	Impermeable	FB
<b>Tba</b>	San Diego 30' x 60'	Fine	Bedrock	Impermeable	FB
<b>Tda</b>	Oceanside 30' x 60'	Fine	Bedrock	Impermeable	FB
<b>Tv</b>	Oceanside 30' x 60'	Fine	Bedrock	Impermeable	FB
<b>Tvsr</b>	Oceanside 30' x 60'	Fine	Bedrock	Impermeable	FB

**Appendix H: Guidance for Investigation Potential Critical Coarse Sediment Yield Areas**

<b>Map Unit</b>	<b>Map Name</b>	<b>Anticipated Grain size of Weathered Material</b>	<b>Bedrock or Sedimentary</b>	<b>Impermeable / Permeable</b>	<b>Geology Grouping</b>
<b>Kgdfg</b>	Oceanside 30' x 60'	Fine	Bedrock	Impermeable	FB
<b>Ta</b>	San Diego 30' x 60'	Fine	Sedimentary	Impermeable	FSI
<b>Tcs</b>	Oceanside 30' x 60'	Fine	Sedimentary	Impermeable	FSI
<b>Td</b>	San Diego & Oceanside 30' x 60'	Fine	Sedimentary	Impermeable	FSI
<b>Td+Tf</b>	San Diego 30' x 60'	Fine	Sedimentary	Impermeable	FSI
<b>Qls</b>	San Diego, Oceanside & El Cajon 30' x 60'	Fine	Sedimentary	Impermeable	FSI
<b>Tm</b>	Oceanside 30' x 60'	Fine	Sedimentary	Impermeable	FSI
<b>Tf</b>	San Diego, Oceanside & El Cajon 30' x 60'	Fine	Sedimentary	Impermeable	FSI
<b>Tfr</b>	El Cajon 30' x 60'	Fine	Sedimentary	Impermeable	FSI
<b>To</b>	San Diego & El Cajon 30' x 60'	Fine	Sedimentary	Impermeable	FSI
<b>Qpe</b>	San Diego & Oceanside 30' x 60'	Fine	Sedimentary	Permeable	FSP
<b>Mexico</b>	San Diego 30' x 60'	NA	NA	Permeable	Other
<b>Kuo</b>	San Diego 30' x 60'	NA (Offshore)	NA	Permeable	Other
<b>Teo</b>	San Diego & Oceanside 30' x 60'	NA (Offshore)	Sedimentary	Permeable	Other
<b>Tmo</b>	Oceanside 30' x 60'	NA (Offshore)	Sedimentary	Permeable	Other
<b>Qmo</b>	San Diego 30' x 60'	NA (Offshore)	Sedimentary	Permeable	Other
<b>QTso</b>	San Diego 30' x 60'	NA (Offshore)	Sedimentary	Permeable	Other
<b>af</b>	San Diego & Oceanside 30' x 60'	Variable, dependent on source material	Sedimentary		Other

## Appendix H: Guidance for Investigation Potential Critical Coarse Sediment Yield Areas

**Table H.6-2: Land Cover Grouping for SanGIS Ecology-Vegetation Data Set**

Id	SanGIS Legend	SanGIS Grouping	Land Cover Grouping
1	42000 Valley and Foothill Grassland	Grasslands, Vernal Pools, Meadows, and Other Herb Communities	Agricultural/Grass
2	42100 Native Grassland		Agricultural/Grass
3	42110 Valley Needlegrass Grassland		Agricultural/Grass
4	42120 Valley Sacaton Grassland		Agricultural/Grass
5	42200 Non-Native Grassland		Agriculture/Grass
6	42300 Wildflower Field		Agriculture/Grass
7	42400 Foothill/Mountain Perennial Grassland		Agriculture/Grass
8	42470 Transmontane Dropseed Grassland		Agriculture/Grass
9	45000 Meadow and Seep		Agriculture/Grass
10	45100 Montane Meadow	Grasslands, Vernal Pools, Meadows, and Other Herb Communities	Agriculture/Grass
11	45110 Wet Montane Meadow		Agriculture/Grass
12	45120 Dry Montane Meadows		Agriculture/Grass
13	45300 Alkali Meadows and Seeps		Agriculture/Grass
14	45320 Alkali Seep		Agriculture/Grass
15	45400 Freshwater Seep		Agriculture/Grass
16	46000 Alkali Playa Community		Agriculture/Grass
17	46100 Badlands/Mudhill Forbs		Agriculture/Grass
18	Non-Native Grassland		Agriculture/Grass
19	18000 General Agriculture	Non-Native Vegetation, Developed Areas, or Unvegetated Habitat	Agriculture/Grass
20	18100 Orchards and Vineyards		Agriculture/Grass
21	18200 Intensive Agriculture		Agriculture/Grass
22	18200 Intensive Agriculture - Dairies, Nurseries, Chicken Ranches		Agriculture/Grass
23	18300 Extensive Agriculture - Field/Pasture, Row Crops		Agriculture/Grass
24	18310 Field/Pasture		Agriculture/Grass
25	18310 Pasture		Agriculture/Grass
26	18320 Row Crops		Agriculture/Grass
27	12000 Urban/Developed		Developed
28	12000 Urban/Developed	Developed	
29	81100 Mixed Evergreen Forest	Forest	Forest
30	81300 Oak Forest		Forest
31	81310 Coast Live Oak Forest		Forest
32	81320 Canyon Live Oak Forest		Forest
33	81340 Black Oak Forest		Forest
34	83140 Torrey Pine Forest		Forest
35	83230 Southern Interior Cypress Forest		Forest
36	84000 Lower Montane Coniferous Forest		Forest
37	84100 Coast Range, Klamath and Peninsular Coniferous Forest		Forest
38	84140 Coulter Pine Forest	Forest	Forest
39	84150 Bigcone Spruce (Bigcone Douglas Fir)-Canyon Oak Forest		Forest



**Appendix H: Guidance for Investigation Potential Critical Coarse Sediment Yield Areas**

<b>Id</b>	<b>SanGIS Legend</b>	<b>SanGIS Grouping</b>	<b>Land Cover Grouping</b>
40	84230 Sierran Mixed Coniferous Forest		Forest
41	84500 Mixed Oak/Coniferous/Bigcone/Coulter		Forest
42	85100 Jeffrey Pine Forest		Forest
43	11100 Eucalyptus Woodland	Non-Native Vegetation, Developed Areas, or Unvegetated Habitat	Forest
44	60000 RIPARIAN AND BOTTOMLAND HABITAT	Riparian and Bottomland Habitat	Forest
45	61000 Riparian Forests		Forest
46	61300 Southern Riparian Forest		Forest
47	61310 Southern Coast Live Oak Riparian Forest		Forest
48	61320 Southern Arroyo Willow Riparian Forest		Forest
49	61330 Southern Cottonwood-willow Riparian Forest		Forest
50	61510 White Alder Riparian Forest		Forest
51	61810 Sonoran Cottonwood-willow Riparian Forest		Forest
52	61820 Mesquite Bosque		Forest
53	62000 Riparian Woodlands		Forest
54	62200 Desert Dry Wash Woodland		Forest
55	62300 Desert Fan Palm Oasis Woodland		Forest
56	62400 Southern Sycamore-alder Riparian Woodland		Forest
57	70000 WOODLAND		Woodland
58	71000 Cismontane Woodland	Forest	
59	71100 Oak Woodland	Forest	
60	71120 Black Oak Woodland	Forest	
61	71160 Coast Live Oak Woodland	Forest	
62	71161 Open Coast Live Oak Woodland	Forest	
63	71162 Dense Coast Live Oak Woodland	Forest	
64	71162 Dense Coast Love Oak Woodland	Forest	
65	71180 Engelmann Oak Woodland	Forest	
66	71181 Open Engelmann Oak Woodland	Forest	
67	71182 Dense Engelmann Oak Woodland	Woodland	Forest
68	72300 Peninsular Pinon and Juniper Woodlands		Forest
69	72310 Peninsular Pinon Woodland		Forest
70	72320 Peninsular Juniper Woodland and Scrub		Forest
71	75100 Elephant Tree Woodland		Forest
72	77000 Mixed Oak Woodland		Forest
73	78000 Undifferentiated Open Woodland		Forest
74	79000 Undifferentiated Dense Woodland		Forest

**Appendix H: Guidance for Investigation Potential Critical Coarse Sediment Yield Areas**

<b>Id</b>	<b>SanGIS Legend</b>	<b>SanGIS Grouping</b>	<b>Land Cover Grouping</b>
75	Engelmann Oak Woodland		Forest
76	52120 Southern Coastal Salt Marsh	Bog and Marsh	Other
77	52300 Alkali Marsh		Other
78	52310 Cismontane Alkali Marsh		Other
79	52400 Freshwater Marsh		Other
80	52410 Coastal and Valley Freshwater Marsh		Other
81	52420 Transmontane Freshwater Marsh		Other
82	52440 Emergent Wetland		Other
83	44000 Vernal Pool	Grasslands, Vernal Pools, Meadows, and Other Herb Communities	Other
84	44320 San Diego Mesa Vernal Pool		Other
85	44322 San Diego Mesa Claypan Vernal Pool (southern mesas)		Other
86	13100 Open Water	Non-Native Vegetation, Developed Areas, or Unvegetated Habitat	Other
87	13110 Marine		Other
88	13111 Subtidal		Other
89	13112 Intertidal		Other
90	13121 Deep Bay		Other
91	13122 Intermediate Bay		Other
92	13123 Shallow Bay		Other
93	13130 Estuarine		Other
94	13131 Subtidal		Other
95	13133 Brackishwater		Other
96	13140 Freshwater	Non-Native Vegetation, Developed Areas, or Unvegetated Habitat	Other
97	13200 Non-Vegetated Channel, Floodway, Lakeshore Fringe		Other
98	13300 Saltpan/Mudflats		Other
99	13400 Beach	Dune Community	Other
100	21230 Southern Foredunes		Scrub/Shrub
101	22100 Active Desert Dunes		Scrub/Shrub
102	22300 Stabilized and Partially-Stabilized Desert Sand Field		Scrub/Shrub
103	24000 Stabilized Alkaline Dunes		Scrub/Shrub
104	29000 ACACIA SCRUB		Scrub/Shrub
105	63000 Riparian Scrubs	Riparian and Bottomland Habitat	Scrub/Shrub
106	63300 Southern Riparian Scrub		Scrub/Shrub
107	63310 Mule Fat Scrub		Scrub/Shrub
108	63310 Mulefat Scrub		Scrub/Shrub
109	63320 Southern Willow Scrub		Scrub/Shrub
110	63321 Arundo donnax Dominant/Southern Willow Scrub		Scrub/Shrub
111	63330 Southern Riparian Scrub		Scrub/Shrub
112	63400 Great Valley Scrub		Scrub/Shrub
113	63410 Great Valley Willow Scrub		Scrub/Shrub
114	63800 Colorado Riparian Scrub		Scrub/Shrub
115	63810 Tamarisk Scrub	Scrub/Shrub	

**Appendix H: Guidance for Investigation Potential Critical Coarse Sediment Yield Areas**

<b>Id</b>	<b>SanGIS Legend</b>	<b>SanGIS Grouping</b>	<b>Land Cover Grouping</b>
116	63820 Arrowweed Scrub		Scrub/Shrub
117	31200 Southern Coastal Bluff Scrub	Scrub and Chaparral	Scrub/Shrub
118	32000 Coastal Scrub		Scrub/Shrub
119	32400 Maritime Succulent Scrub		Scrub/Shrub
120	32500 Diegan Coastal Sage Scrub		Scrub/Shrub
121	32510 Coastal form		Scrub/Shrub
122	32520 Inland form (> 1,000 ft. elevation)		Scrub/Shrub
123	32700 Riversidian Sage Scrub		Scrub/Shrub
124	32710 Riversidian Upland Sage Scrub		Scrub/Shrub
125	32720 Alluvial Fan Scrub		Scrub/Shrub
126	33000 Sonoran Desert Scrub		Scrub/Shrub
127	33100 Sonoran Creosote Bush Scrub		Scrub/Shrub
128	33200 Sonoran Desert Mixed Scrub		Scrub/Shrub
129	33210 Sonoran Mixed Woody Scrub		Scrub/Shrub
130	33220 Sonoran Mixed Woody and Succulent Scrub		Scrub and Chaparral
131	33230 Sonoran Wash Scrub	Scrub/Shrub	
132	33300 Colorado Desert Wash Scrub	Scrub/Shrub	
133	33600 Encelia Scrub	Scrub/Shrub	
134	34000 Mojavean Desert Scrub	Scrub/Shrub	
135	34300 Blackbush Scrub	Scrub/Shrub	
136	35000 Great Basin Scrub	Scrub/Shrub	
137	35200 Sagebrush Scrub	Scrub/Shrub	
138	35210 Big Sagebrush Scrub	Scrub/Shrub	
139	35210 Sagebrush Scrub	Scrub/Shrub	
140	36110 Desert Saltbush Scrub	Scrub/Shrub	
141	36120 Desert Sink Scrub	Scrub/Shrub	
142	37000 Chaparral	Scrub/Shrub	
143	37120 Southern Mixed Chaparral	Scrub/Shrub	
144	37120 Southern Mixed Chapparal	Scrub/Shrub	
145	37121 Granitic Southern Mixed Chaparral	Scrub/Shrub	
146	37121 Southern Mixed Chaparral	Scrub/Shrub	
147	37122 Mafic Southern Mixed Chaparral	Scrub/Shrub	
148	37130 Northern Mixed Chaparral	Scrub/Shrub	
149	37131 Granitic Northern Mixed Chaparral	Scrub/Shrub	
150	37132 Mafic Northern Mixed Chaparral	Scrub/Shrub	
151	37200 Chamise Chaparral	Scrub/Shrub	
152	37210 Granitic Chamise Chaparral	Scrub/Shrub	
153	37220 Mafic Chamise Chaparral	Scrub/Shrub	
154	37300 Red Shank Chaparral	Scrub/Shrub	
155	37400 Semi-Desert Chaparral	Scrub/Shrub	
156	37500 Montane Chaparral	Scrub/Shrub	
157	37510 Mixed Montane Chaparral	Scrub/Shrub	
158	37520 Montane Manzanita Chaparral	Scrub/Shrub	
159	37530 Montane Ceanothus Chaparral	Scrub/Shrub	

## Appendix H: Guidance for Investigation Potential Critical Coarse Sediment Yield Areas

Id	SanGIS Legend	SanGIS Grouping	Land Cover Grouping
160	37540 Montane Scrub Oak Chaparral		Scrub/Shrub
161	37800 Upper Sonoran Ceanothus Chaparral		Scrub/Shrub
162	37830 Ceanothus crassifolius Chaparral		Scrub/Shrub
163	37900 Scrub Oak Chaparral		Scrub/Shrub
164	37A00 Interior Live Oak Chaparral		Scrub/Shrub
165	37C30 Southern Maritime Chaparral	Scrub and Chaparral	Scrub/Shrub
166	37G00 Coastal Sage-Chaparral Scrub		Scrub/Shrub
167	37K00 Flat-topped Buckwheat		Scrub/Shrub
168	39000 Upper Sonoran Subshrub Scrub		Scrub/Shrub
169	Diegan Coastal Sage Scrub		Scrub/Shrub
170	Granitic Northern Mixed Chaparral		Scrub/Shrub
171	Southern Mixed Chaparral	Non-Native Vegetation, Developed Areas, or Unvegetated Habitat	Scrub/Shrub
172	11000 Non-Native Vegetation		Unknown
173	11000 Non-Native VegetationVegetation		Unknown
174	11200 Disturbed Wetland		Unknown
175	11300 Disturbed Habitat		Unknown
176	13000 Unvegetated Habitat		Unknown
177	Disturbed Habitat		Unknown

## Appendix H: Guidance for Investigation Potential Critical Coarse Sediment Yield Areas

**Table H.6-3: Potential Critical Coarse Sediment Yield Areas**

GLU	Geology	Land Cover	Slope (%)
CB-Agricultural/Grass-3	Coarse Bedrock	Agricultural/Grass	20% - 40%
CB-Agricultural/Grass-4	Coarse Bedrock	Agricultural/Grass	>40%
CB-Forest-2	Coarse Bedrock	Forest	10 – 20%
CB-Forest-3	Coarse Bedrock	Forest	20% - 40%
CB-Forest-4	Coarse Bedrock	Forest	>40%
CB-Scrub/Shrub-4	Coarse Bedrock	Scrub/Shrub	>40%
CB-Unknown-4	Coarse Bedrock	Unknown	>40%
CSI-Agricultural/Grass-2	Coarse Sedimentary Impermeable	Agricultural/Grass	10 – 20%
CSI-Agricultural/Grass-3	Coarse Sedimentary Impermeable	Agricultural/Grass	20% - 40%
CSI-Agricultural/Grass-4	Coarse Sedimentary Impermeable	Agricultural/Grass	>40%
CSP-Agricultural/Grass-4	Coarse Sedimentary Permeable	Agricultural/Grass	>40%
CSP-Forest-3	Coarse Sedimentary Permeable	Forest	20% - 40%
CSP-Forest-4	Coarse Sedimentary Permeable	Forest	>40%
CSP-Scrub/Shrub-4	Coarse Sedimentary Permeable	Scrub/Shrub	>40%

**Appendix H: Guidance for Investigation Potential Critical Coarse Sediment Yield Areas**

**Worksheet H.6-1: Verification of GLUs**

Verification of GLUs		Worksheet H.6-1
<p>Detailed project-level review of GLUs may be performed to verify the presence or absence of potential critical coarse sediment yield areas within the project site and/or upstream areas. Use this form to document the evaluation of slope, geology, and land cover combined to determine the site-specific GLUs. Complete all sections of this form.</p>		
<p>Project Name:</p>		
<p>Project Tracking Number / Permit Application Number:</p>		
1	<p>What are the pre-project slopes?</p>	<input type="checkbox"/> 0% to 10% (1) <input type="checkbox"/> 10% to 20% (2) <input type="checkbox"/> 20% to 40% (3) <input type="checkbox"/> >40% (4)
2	<p>What is the underlying geology? Refer to Appendix H.6 to classify geologic categories into a geology grouping.</p> <p>Note: site-specific geology may be determined in the field by a qualified geologist.</p>	<input type="checkbox"/> Coarse bedrock (CB) <input type="checkbox"/> Coarse sedimentary impermeable (CSI) <input type="checkbox"/> Coarse sedimentary permeable (CSP) <input type="checkbox"/> Fine bedrock (FB) <input type="checkbox"/> Fine sedimentary impermeable (FSI) <input type="checkbox"/> Fine sedimentary permeable (FSP) <input type="checkbox"/> Other (O)
3	<p>What is the pre-project land cover? Refer to Appendix H.6 for land cover category definitions.</p> <p>Note: Land cover shall be determined from aerial photography and/or field visit.</p>	<input type="checkbox"/> Agriculture/grass <input type="checkbox"/> Forest <input type="checkbox"/> Developed <input type="checkbox"/> Scrub/shrub <input type="checkbox"/> Other <input type="checkbox"/> Unknown
4	<p>List the GLU(s) within the project site and/or upstream areas.</p> <p>Note the GLU nomenclature format is as follows: Geology – Land Cover – Slope Category (e.g. “CB-Agricultural/Grass-3” for a GLU consisting of coarse bedrock geology, agricultural/grass land cover, and 20% to 40% slope).</p>	

**Appendix H: Guidance for Investigation Potential Critical Coarse Sediment Yield Areas**

Worksheet H.6-1; Page 2 of 2		
5	Photo(s) Insert photos representative of the slopes, land cover, and geology.	
6	Are any of the GLUs found within the project boundary and/or upstream areas (listed in row 4) also listed in Table H.6-1?	<input type="checkbox"/> Yes  <input type="checkbox"/> No
		Go to 7  Go to 8
7	End – Provide management measures for preservation of coarse sediment supply as described in this guidance document, or the project applicant may elect to determine whether downstream systems would be sensitive to reduction of coarse sediment yield from the project site and/or perform site-specific method for mapping critical coarse sediment yield areas.	
8	End – Site-specific GLUs do not warrant preservation of coarse sediment supply, no measures for protection of critical coarse sediment yield areas onsite are necessary. Optional: use the note section below to provide justification for these findings.	
9	Notes	

## Appendix H: Guidance for Investigation Potential Critical Coarse Sediment Yield Areas

### H.6.2 Assumptions for Regional WMAA PCCSYA Maps

This section summarizes the assumptions used while developing Regional WMAA PCCSYA maps that are not listed in Appendix H.6.1.1:

- Critical coarse sediment would be generated from GLUs that are
  - composed of geologic units likely to generate coarse sediment (i.e. produces greater than 50% sand (0.074 mm; no. 200 sieve) by weight when weathered); and
  - have a potential for high relative sediment production (GLUs that produce soil loss greater than 8.4 tons/acre/year are assigned a high relative rating, this corresponds to 42% of the total coarse soil loss from the MS4-permitted region within the County of San Diego)
- Relative sediment production was assigned using RUSLE analysis of GLUs. It was assumed that this relative rating represents sediment production from sheet erosion, rill erosion, gullies and lower order channels, since these features are mostly on the hillslopes that are represented by the GLUs.
  - While performing the RUSLE analysis to assign the relative ranking, C factor from the regional maps from USEPA was adjusted to 0 for developed land covers to account for management actions implemented on developed sites (e.g. impervious surfaces).
- WMAA mapping does not account for sediment production from in-stream sediment supply (since these are mostly protected through other regulations) and sediment production from mass failures like landslides which are difficult to estimate on a regional scale without performing extensive field investigations.
- Regional WMAA map assumes that all receiving waters require coarse sediment and the map also does not account for potential existing impediments that may hinder delivery of coarse sediment to receiving waters.

For additional details refer to the Regional WMAA document on the Project Clean Water website at the following address:

[http://www.projectcleanwater.org/index.php?option=com\\_content&view=article&id=248&Itemid=219](http://www.projectcleanwater.org/index.php?option=com_content&view=article&id=248&Itemid=219)



## Appendix H: Guidance for Investigation Potential Critical Coarse Sediment Yield Areas

### H.6.3 Encroachment Allowance for Regional PCCSYA WMAA Map

When an applicant uses the regional PCCSYA map from WMAA to define onsite CCSYAs an encroachment allowance of up to 5% within each POC drainage boundary is allowed.

The following provides the supporting rational for 5% encroachment:

- Step 1. Sp has to be greater than 0.5, based on current understanding of risks to receiving waters arising from changes in sediment production (SCCWRP Technical Report 605, 2010).
- Step 2. Estimated Sp (Equation H.8.11) =  $0.7*SY_{RUSLE} + 0.3*SY_{NHD} = 0.7*0.42 + 0.3*1 = 0.59$ 
  - a. Based on RUSLE analysis conducted during Regional WMAA the GLUs mapped as PCCSYAs contribute 42% of the bed sediment yield (i.e.  $SY_{RUSLE} = 0.42$ )
  - b. Disturbance to NHDPlus channels are protected through 401 water quality certifications issued by the RWQCB, so it is assumed that  $SY_{NHD} = 1$
- Step 3. Dividing the Sp estimate from Step 2 by the required Sp in Step 1 provides the factor of safety that is currently implicit in the regional WMAA PCCSYA map =  $0.59/0.5 = 1.18$  or 18% factor of safety
- Step 4. The remaining factor of safety after accounting for the proposed encroachment of 5% =  $18\% - 5\% = 13\%$

### H.7 Downstream System Sensitivity to Coarse Sediment

If an applicant has identified onsite and/or upstream PCCSYAs and elects to perform additional optional analyses to refine the PCCSYA designation, the guidance presented below should be followed. Protection of critical coarse sediment yield areas is a necessary element of hydromodification management because coarse sediment supply is as much an issue for causing erosive conditions to receiving streams as are accelerated flows. However, not all downstream systems warrant preservation of coarse sediment supply nor all source areas need to be protected. The following guidance shall be used to refine PCCSYA designations:

- Depositional Analysis (Appendix H.7.1)
- Threshold Channel Analysis (Appendix H.7.2)
- Coarse Sediment Source Area Verification (Appendix H.7.3)

#### H.7.1 Depositional Analysis

Areas identified as PCCSYAs may be removed from consideration if it is demonstrated that these sources are deposited into existing systems prior to reaching the first downstream unlined water of the state. Systems resulting in deposition may include existing natural sinks, existing structural BMPs, existing hardened MS4 systems, or other existing similar features. Applicants electing to perform depositional analysis to refine PCCSYA mapping must meet the following criteria to qualify for exemption from CCSYA designation:

- The existing hardened MS4 system that is being analyzed should be upstream of the first downstream unlined waters of the state; **and**
- The peak velocity from the discrete 2-year, 24-hour runoff event for the existing hardened MS4 system that is being analyzed is less than three feet per second.

The three feet per second criteria is consistent with the recommended minimum velocity for storm and sanitary sewers in ASCE Manual of Engineering Practice No. 37 (ASCE, 1970).

In limited scenarios, applicant may have the option to establish site specific minimum self-cleansing velocity using Equation H.7-1 or other appropriate equations instead of using the default three feet per second criteria. This site specific analysis must be documented in the SWQMP and the City Engineer has the discretion to request additional analysis prior to approving a site specific minimum self-cleansing velocity. If an applicant chooses to establish a site specific minimum self-cleansing velocity for refinement, then the applicant must design any new bypass hardened conveyance systems proposed by the project to meet the site specific criteria.

Equation H.7-1: Minimum Self Cleansing Velocity

$$V = \frac{1.486}{n} R^{1/6} [B(s_g - 1)D_g]^{1/2}$$

Where:

V = minimum self-cleansing velocity (ft/sec)

R = hydraulic radius (ft)

n = Manning's roughness coefficient (unitless)

B = constant equal to 0.04 for clean granular particles (unitless)

sg = specific gravity of sediment particle (unitless): Use 2.65

Dg = sediment particle diameter (inches): Use 0.20 in

## H.7.2 Threshold Channel Analysis

A threshold channel is a stream channel in which channel boundary material has no significant movement during the design flow. If there is no movement of bed load in the stream channel, then it is not anticipated that reductions in sediment supply will be detrimental to stream stability because the channel bed consists of the parent material and not coarse sediment supplied from upstream. In such a situation, changes in sediment supply are not considered a geomorphic condition of concern. SCCWRP Technical Report 562 (2008) states the following in regards to sand vs. gravel bed behavior/threshold vs. live-bed contrasts:

“Sand and gravel systems are quite varied in their transport of sediment and their sensitivity to sediment supply. On the former, sand-bed channels typically have live beds, which transport sediment continuously even at relatively low flows. Conversely, gravel/cobble-bed channels generally transport the bulk of their bed sediment load more episodically, requiring higher flow events for bed mobility (i.e., threshold behavior).”

“Sand-bed streams without vertical control are much more sensitive to perturbations in flow and sediment regimes than coarse-grain (gravel/cobble) threshold channels. This has clear implications in their respective management regarding hydromodification (i.e., sand systems being relatively more susceptible than coarser systems). This also has direct implications for the issue of sediment trapping by storm water practices in watersheds draining to sand-bed streams, as well as general loss of sediment supply following the conversion from undeveloped sparsely-vegetated to developed well-vegetated via irrigation.”

The following provides guidance for evaluating whether a stream channel is a threshold channel or not. This determination is important because while accounting for changes in bed sediment supply is appropriate for quantifying geomorphic impacts in non-threshold stream channels, it is not considered appropriate for threshold channels. The domain of analysis for this evaluation shall be the same as that used to evaluate susceptibility, per SCCWRP Technical Report 606, Field Manual for Assessing

## Appendix H: Guidance for Investigation Potential Critical Coarse Sediment Yield Areas

Channel Susceptibility (2010). This domain is defined by the following upstream and downstream boundaries:

- From the point of compliance proceed downstream until reaching one of the following:
  - At least one reach downstream of the first grade-control point (preferably second downstream grade control location);
  - Tidal backwater/lentic (still water) waterbody;
  - Equal order tributary (Strahler 1952);
  - A 2-fold increase in drainage area.

OR demonstrate sufficient flow attenuation through existing hydrologic modeling.

- From the point of compliance proceed upstream for 20 channel top widths OR to the first grade control in good condition, whichever comes first.

Applicant must complete Worksheet H.7-1 to document selection of the domain of analysis. If the entire domain of analysis is classified as a threshold channel, then the PDP can be exempt from the MS4 Permit requirement for sediment supply. The following definitions from the Natural Resources Conservation Service's (NRCS) National Engineering Handbook Part 654 - Stream Restoration Design (2007) are helpful in understanding what a threshold channel is.

- **Alluvial Channel**: Streams and channels that have bed and banks formed of material transported by the stream. There is an exchange of material between the inflowing sediment load and the bed and banks of an alluvial channel (NRCS, 2007).
- **Threshold Channel**: A channel in which channel boundary material has no significant movement during the design flow (NRCS, 2007).

The key factor for determining whether a channel is a threshold channel is the composition of its bed material. Larger bed sediment consisting primarily of cobbles and boulders are typically immobile, unless the channel is a large river with sufficient discharge to regularly transport such grain sizes as bed load. As a rule-of-thumb, channels with bed material that can withstand a 10-year peak discharge without incipient motion are considered threshold channels and not live-bed alluvial channels. Threshold channel beds typically consist of cobbles, boulders, bedrock, or very dense vegetation (e.g., a thicket). Threshold channels also includes channels that have existing grade control structures that protect the stream channels from hydromodification impacts.

For a project to be exempt from coarse sediment supply requirements, the applicant must submit the following for approval to the City Engineer:

- Photographic documentation and grain size analysis used to determine the  $d_{50}$  of the bed material; and
- Calculations that show that the receiving water of concern meets the specific stream power criteria defined below or a finding from a geomorphologist that the stream channel has existing grade control structures that protect the stream channel from hydromodification impacts.

### **Specific Stream Power**

## Appendix H: Guidance for Investigation Potential Critical Coarse Sediment Yield Areas

Specific (i.e., unit) stream power is the rate at which the energy of flowing water is expended on the bed and banks of a channel (refer to Equation H.7-1). SCCWRP studies have found that locating channels on a plot of Specific Stream Power at  $Q_{10}$  (as calculated by the Hawley et al. method optimized for Southern California watersheds – Figure H.7-1) versus median channel grain size is a good predictor of channel stability. The  $Q_{10}$  equation from SCCWRP TR 606 is presented as Equation H.7-2.

### Equation H.7-2: Calculation of Specific Stream Power

$$\text{Specific Stream Power} = \frac{\text{Total Stream Power}}{\text{Channel Width}} = \frac{\gamma QS}{w}$$

Where:

$\gamma$ : Specific Weight of Water (9810 N/m<sup>3</sup>)

Q: Flow Rate (dominant discharge in many cases, m<sup>3</sup>/sec)

S: Slope of Channel

w: Channel Width (meters)

### Equation H.7-3: Calculation of $Q_{10}$ using the Hawley et al. method

$$Q_{10\text{cfs}} = 18.2 * A^{0.87} * P^{0.77}$$

Where:

$Q_{10\text{cfs}}$ : 10 year Flow Rate in cubic feet per second

A: Drainage Area in sq. miles

P: Mean Annual Precipitation in inches

## Appendix H: Guidance for Investigation Potential Critical Coarse Sediment Yield Areas

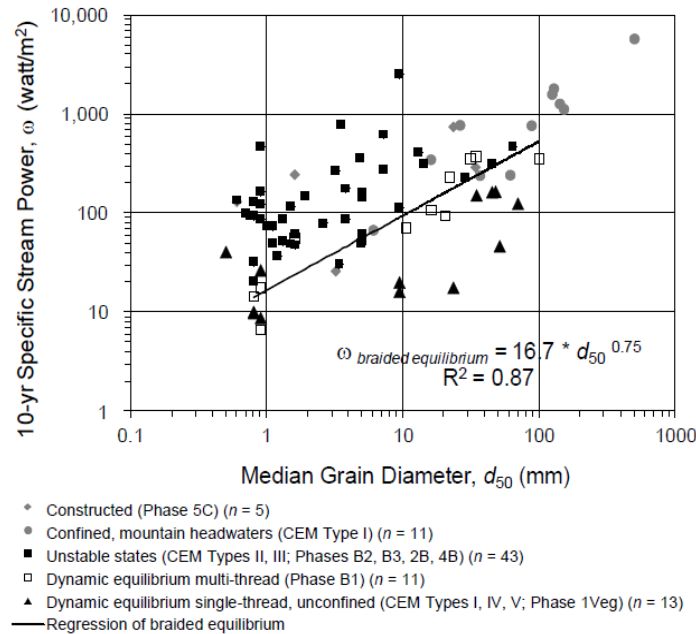

**Figure H.7-1: Threshold of stream instability based on specific stream power and channel sediment diameter**

Since the SCCWRP TR 606  $Q_{10}$  (Equation H.7-3) does not explicitly consider watershed imperviousness, adjustment factors (AF) shown in Figure H.7-2 were developed using the following Equation H.7-4 for  $Q_{10}$  from SCCWRP TR 654 to account for imperviousness while estimating  $Q_{10}$ .

### Equation H.7-4: Calculation of $Q_{10}$ using equation from SCCWRP TR 654

$$Q_{10} = e^{3.61} * A^{0.865} * DD^{0.804} * P_{224}^{0.778} * IMP^{0.096}$$

Where:

- $Q_{10}$ : 10 year Flow Rate
- A: Drainage Area in sq. miles
- DD: Drainage Density
- $P_{224}$ : 2-Year 24-Hour Precipitation in inches
- IMP: Watershed Imperviousness

Adjustment factors were developed as part of this methodology by changing the watershed imperviousness in Equation H.7-4 and keeping the remaining terms constant. Adjustment factor for imperviousness of 3.6% was set to 1; since it is the mean imperviousness of the dataset used to develop the stability curve in Figure H.7-1. Updated  $Q_{10}$  equation with adjustment factor is presented as Equation H.7-5 below:

## Appendix H: Guidance for Investigation Potential Critical Coarse Sediment Yield Areas

### Equation H.7-5: Calculation of $Q_{10}$ with Adjustment Factor for Watershed Imperviousness

$$Q_{10cfs} = AF * 18.2 * A^{0.87} * P^{0.77}$$

Where:

$Q_{10cfs}$ : 10 year Flow Rate in cubic feet per second

AF: Adjustment Factor

A: Drainage Area in sq. miles

P: Mean Annual Precipitation in inches

## Appendix H: Guidance for Investigation Potential Critical Coarse Sediment Yield Areas

This page was intentionally left blank.



Appendix H: Guidance for Investigation Potential Critical Coarse Sediment Yield Areas

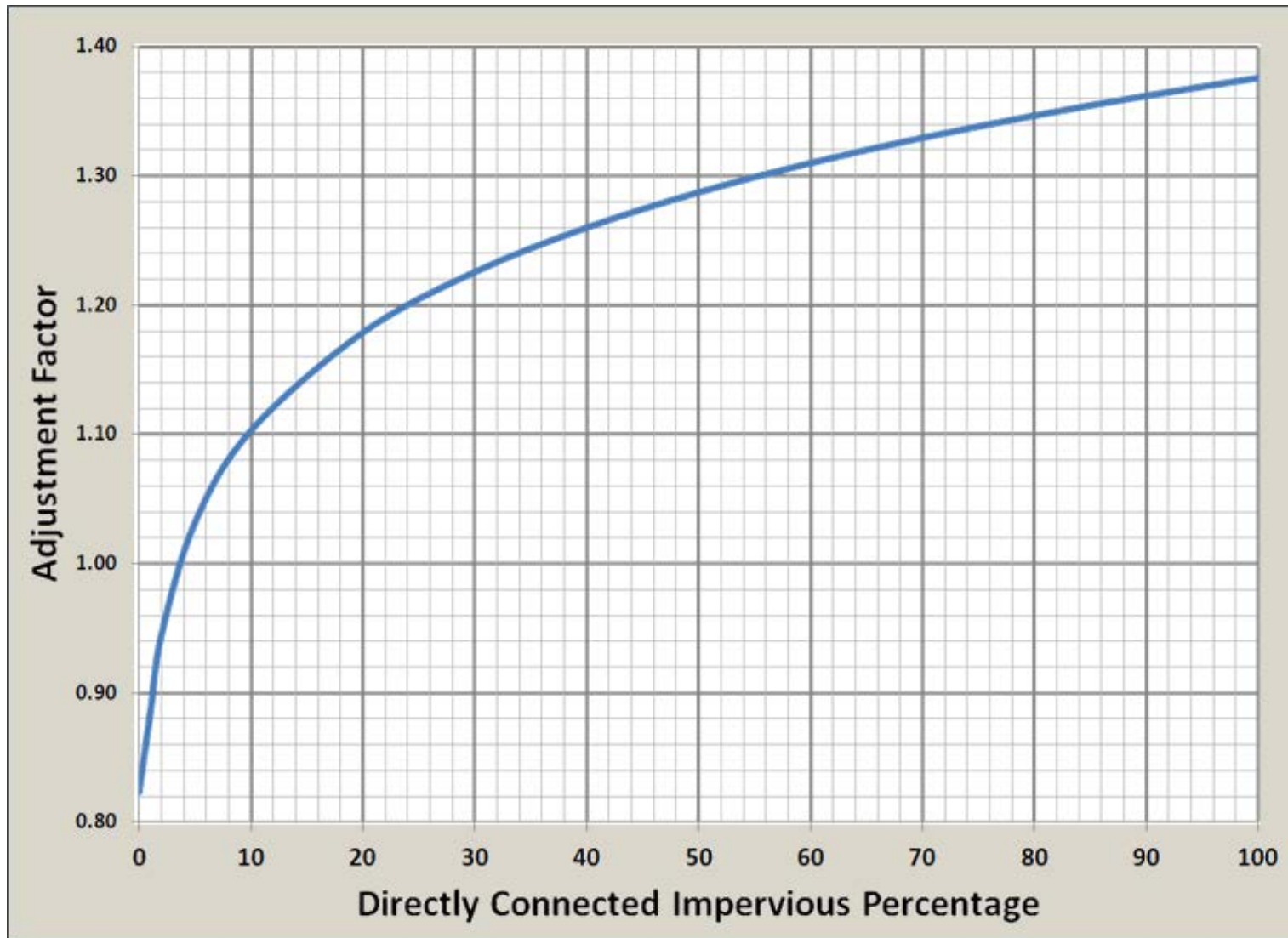

Figure H.7-2: Adjustment factor to account for imperviousness while estimating  $Q_{10}$

## Appendix H: Guidance for Investigation Potential Critical Coarse Sediment Yield Areas

This page was intentionally left blank.

## Appendix H: Guidance for Investigation Potential Critical Coarse Sediment Yield Areas

Steps for evaluating the specific stream power criteria are presented below:

- **Step 1:** Calculate the specific stream power for the receiving water. Use Equation H.7-1, H.7-4 and Figure H.7-2. Directly connected imperviousness shall be estimated using guidance provided in the Water Quality Equivalency guidance document.
- **Step 2:** Determine the  $d_{50}$  of representative cross section within the domain of analysis.
- **Step 3:** Use results from Step 1 and Step 2; and Figure H.7-1 to determine if the receiving water meets the specific stream power criteria. Receiving water shall be considered meeting the specific stream power criteria when the point plotted based on results from Step 1 and Step 2 is below the solid line in Figure H.7-1.

### H.7.3 Coarse Sediment Source Area Verification

When it has been determined that PCCSYAs are present, and it has been determined that downstream systems require protection, additional analysis may be performed that may refine the extents of actual CCSYAs to be protected onsite. The following analysis shall be performed to determine if the mapped PCCSYAs are a significant source of bed sediment supply to the receiving water, based on the coarse sediment proportion of the soil onsite

- Obtain a grain size distribution per ASTM D422 for the project's PCCSYA that is being evaluated.
- Identify whether the source material is a coarse grained or fine grained soil. Coarse grained is defined as over 50% by weight coarse than no. 200 sieve (i.e.,  $d_{50} > 0.074$  mm).
- By performing this analysis, the applicant can exclude PCCSYAs that are determined to be fine grained (i.e.,  $d_{50} < 0.074$  mm). Fine grained soils are not considered significant sources of bed sediment supply.
- Applicant shall include the following information in the SWQMP when this refinement option is performed:
  - Map with locations on where the grain size distribution analysis was performed;
  - Photographic documentation; and
  - Grain size distribution.
- Additional grain size distribution analysis may be requested at specific locations by the County prior to approval of this refinement.

Areas that are not expected to be a significant source of bed sediment supply (i.e. fine grained soils) to the receiving stream do not require protection and are not considered CCSYAs.

If it is determined that the PCCSYAs are producing sediment that is critical to receiving streams, or if the optional additional analysis presented above has not been performed, the project must provide management measures for protection of critical coarse sediment yield (refer to Appendix H.2, H.3 and H.4).

## Appendix H: Guidance for Investigation Potential Critical Coarse Sediment Yield Areas

This page was intentionally left blank.

**Appendix H: Guidance for Investigation Potential Critical Coarse Sediment Yield Areas**

**Worksheet H.7-1: Domain of Analysis**

Domain of Analysis		Worksheet H.7-1
Use this form to document the domain of analysis		
Project Name:		
Project Tracking Number / Permit Application Number:		
<b>Part 1: Identify Domain of Analysis</b>		
Project Location (at proposed storm water discharge point)		
1	Address:	
2	Latitude (decimal degrees):	
3	Longitude (decimal degrees):	
4	Watershed:	
Basis for determining downstream limit:		
Channel length from discharge point to downstream limit:		
Basis for determining upstream limit:		
Channel length from discharge point to upstream limit:		

**Appendix H: Guidance for Investigation Potential Critical Coarse Sediment Yield Areas**

**Worksheet H.7-1; Page 2 of 2**

Photo(s)

Map or aerial photo of site. Include channel alignment and tributaries, project discharge point, upstream and downstream limits of analysis, ID number and boundaries of geomorphic channel units, and any other features used to determine limits (e.g. exempt water body, grade control)

### H.8 Calculation Methodology for $E_p$ and $S_p$

One method for quantifying hydromodification impacts to stream channels, which takes into account changes in the four factors in Lane's relationship (i.e., hydrology, channel geometry, bed and bank material, and sediment supply), is to compare long-term changes in sediment transport capacity, or in-stream work, to bed sediment supply. For the purposes of demonstrating no net impact within the MS4-permitted region of the County of San Diego, Erosion Potential ( $E_p$ ) is defined as the ratio of post-project/pre-development (natural) long-term transport capacity or work. To calculate  $E_p$ , the hydrology, channel geometry, and bed/bank material factors mentioned above need to be characterized for both land use scenarios. Sediment Supply Potential ( $S_p$ ) is defined as the ratio of post-project/pre-project (existing) long-term bed sediment supply. While evaluating changes in discharge and sediment supply is done primarily as a desktop analysis, geomorphic field assessment is often necessary to characterize channel geometry and bed/bank material, and to ground truth assumptions for the desktop analyses. This appendix provides methodologies for the following:

- Calculation of  $E_p$ , and
- Calculation of  $S_p$ .

#### H.8.1 Calculation of $E_p$

Erosion Potential ( $E_p$ ) is defined as the ratio of post-project/pre-development (natural) long-term transport capacity or work. To calculate  $E_p$ , the hydrology, channel geometry, and bed/bank material factors mentioned above need to be characterized for both land use scenarios. Traditionally,  $E_p$  is calculated based on a watershed-scale analysis (using future built out conditions) of the area tributary to a given receiving channel of concern at the point of compliance. However, watershed-scale continuous hydrologic modeling might not be feasible for small projects, with this understanding specific simplification steps for project-scale modeling are provided in this appendix. The applicant shall perform  $E_p$  calculations using one of the following methods, as applicable:

- **Simplified  $E_p$  Method:** Applicable when the default low flow threshold of  $0.1Q_2$  is used and no changes to the receiving water are proposed. Refer to Appendix H.8.1.1.
- **Standard  $E_p$  Method:** Applicable for all scenarios. Refer to Appendix H.8.1.2.

##### H.8.1.1 Simplified $E_p$ Method

The simplified method is based on the relationships developed by Parra (2016) between the flow duration curve in the pre-development and post-project conditions and the standard simplified work equation. These relationships were developed using standard hydraulic equations and approximations that are applicable for channels of any lateral slope and the following geometrical cross sections: (a) wide rectangular sections; (b) relatively wide parabolic sections, and (c) triangular sections. The simplified  $E_p$  method is only applicable when the default low flow threshold of  $0.1Q_2$  has been selected by the applicant for flow duration control and no changes to the receiving water geometry are proposed. Applicants shall follow Steps 1 through 3 to calculate  $E_p$  using the simplified methodology:

## Appendix H: Guidance for Investigation Potential Critical Coarse Sediment Yield Areas

1. Perform continuous hydrologic simulation for the pre-development and post-project condition following guidelines in Appendix G. Generate flow bins and flow duration tables for the range of flows from  $0.1Q_2$  to  $Q_{10}$ .
2. Calculate the total work in the pre-development and the post-project condition using Equation H.8.1

### Equation E.8-1: Total Work (Simplified)

$$W_t = \sum_{j=1}^n \Delta t_j \cdot (Q^{3m/2} - (0.1Q_2)^{3m/2}) Q^{1.5m}$$

Where:

$W_t$  = Total Work [dimensionless]

$\Delta t_j$  = Duration per flow bin

$Q$  = Flow Rates estimated in STEP 1 [cfs] for a typical bin “j”. Usually, in Flow Duration Curve (FDC) analyses, the number of bins is 100, so  $j = 1$  to  $n$  (with  $n = 100$ ). However, the number of bins can be as small as 20 ( $n = 20$ ).

$Q_2$  = Pre-development 2-year peak flow [cfs]

$m$  = exponent based on the function of the receiving channels geometry.

- For narrow creek where the top width is 7 times or less the corresponding depth,  $m = 1/4$ .
- For intermediate creeks, where the top width is more than 7 times but less than 25 times the depth,  $m = 4/13$ .
- For wide creeks, where the top width is more than 25 times the depth,  $m = 2/5$ .

3.  $E_p$  is calculated by dividing the total work of the post-project condition by that of the pre-development (natural) condition (Equation H.8-2).  $E_p$  is expressed as:

### Equation H.8-2: $E_p$ (Simplified)

$$E_p = W_{t,post} / W_{t,pre}$$

Where:

$E_p$  = Erosion Potential [unitless]

$W_{t,post}$  = Total Work associated with the post-project condition [unitless]

$W_{t,pre}$  = Total Work associated with the pre-development condition [unitless]



### H.8.1.2 Standard Ep Method

While using the standard method, Ep calculation must be performed using the receiving water information from the point of compliance. Suggested steps for performing an Ep analysis are shown in the Figure H.8-1 below. This section describes each analysis step shown in Figure H.8-1, including the inputs and outputs of each step.

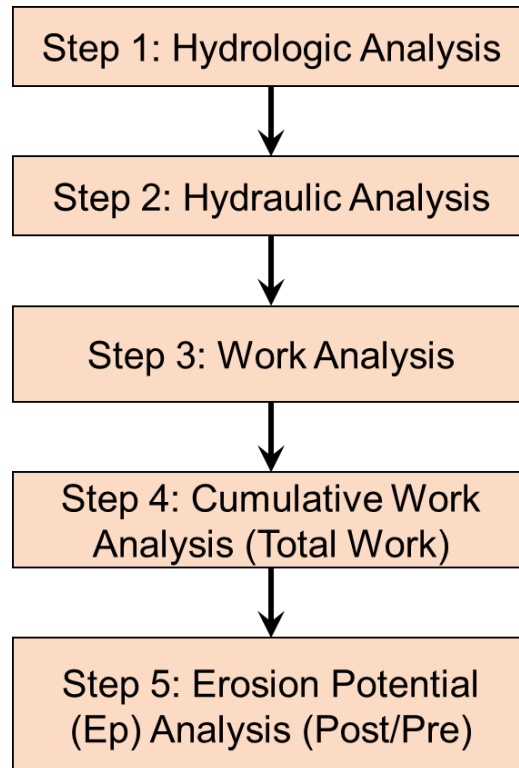

Figure H.8-1: Erosion Potential Flow Chart

#### STEP 1: CONTINUOUS HYDROLOGIC ANALYSIS

Hydrologic models are applied to simulate the hydrologic response of the watershed under pre-development and post-project conditions for a continuous period of record. Modeling software appropriate for this type of simulation includes USEPA’s Storm Water Management Model (SWMM), Hydrological Simulation Program – Fortran (HSPF) developed by the USGS and USEPA, USACE’s Hydrologic Modeling System (HEC-HMS), and the San Diego Hydrology Model (SDHM) developed by Clear Creek Solutions, Inc. SDHM uses an HSPF computational engine, long-term precipitation data, and is a visually-oriented interactive tool for automated modeling and facility sizing.

Input parameters for these continuous simulations are hourly precipitation data for a long-term (>30 years) record, sub-catchment delineation, impervious cover, soil type, vegetative cover, terrain steepness, lag time or flow path length, and monthly evapotranspiration rate. The primary output is a simulated discharge record associated with the receiving channel of concern. Flow routing through

## Appendix H: Guidance for Investigation Potential Critical Coarse Sediment Yield Areas

drainage conveyances is necessary for continuous hydrologic analysis at the watershed scale. Appendix G provides guidance for developing continuous simulation models.

Traditionally, a hydrograph (Figure H.8-2) is the primary means for graphically comparing discharge records; however, a hydrograph is not ideal because long-term flow records span several decades.

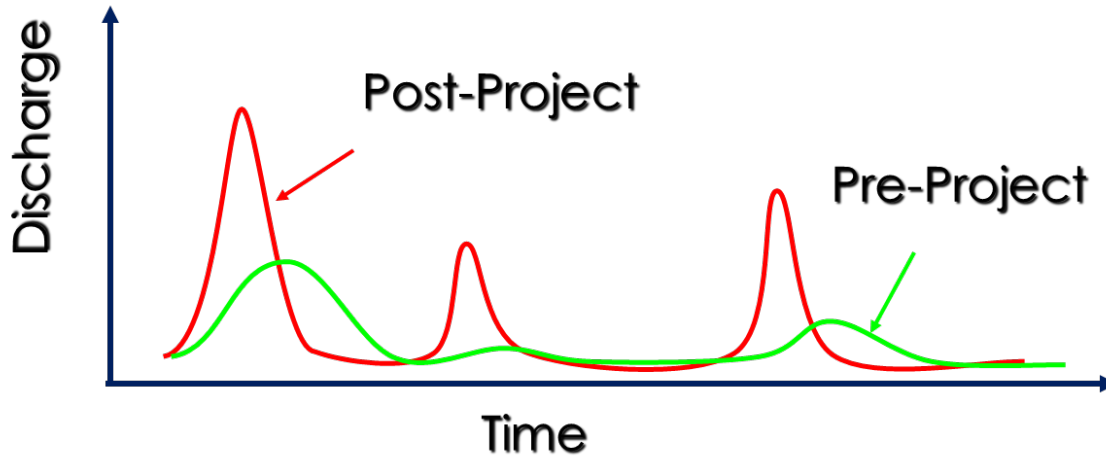

Figure H.8-2: Example Hydrograph Comparison

Instead, a more effective means for comparing long-term continuous discharge records is to create a flow histogram, which differentiates the simulated flowrates into distinct “flow bins” so that the duration of flow for each bin can be tabulated. One method for establishing the distribution of flow bins is to increment the flow bins according to increments of flow stage using a hydraulic analysis, such as the normal depth equation. In this way, the hydraulic analysis step (Step 2) can be considered an input to the continuous hydrologic analysis step. While there is no established rule of thumb for how many flow bins are necessary, it is suggested that no less than 20 be used for an Ep analysis. An example of a flow histogram is provided on Figure H.8-3.

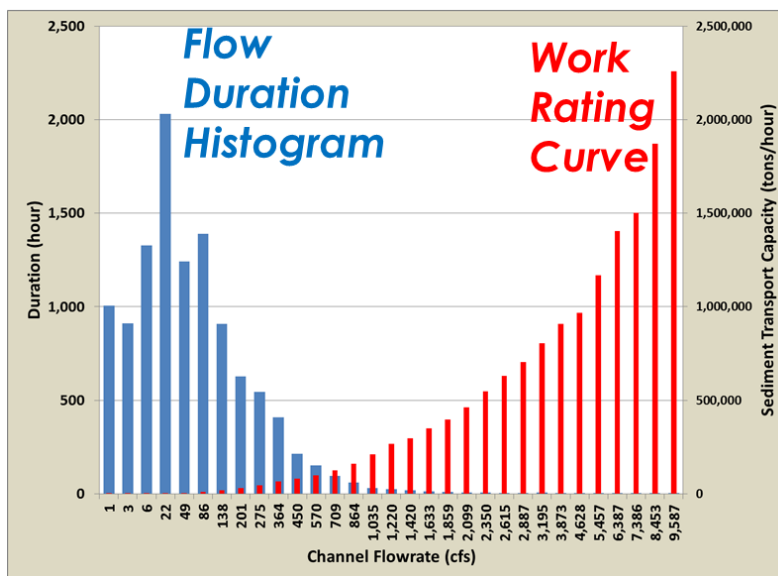

Figure H.8-3: Example Flow Duration Histogram

## Appendix H: Guidance for Investigation Potential Critical Coarse Sediment Yield Areas

Flow duration curves are another commonly used method for graphically interpreting long-term flow records. A flow duration curve is simply a plot of flowrate (y-axis) versus the cumulative duration, or percentage of time, that a flowrate is equaled or exceeded in the simulation record (x-axis). Figure H.8-4 provides an example flow duration curve comparison.

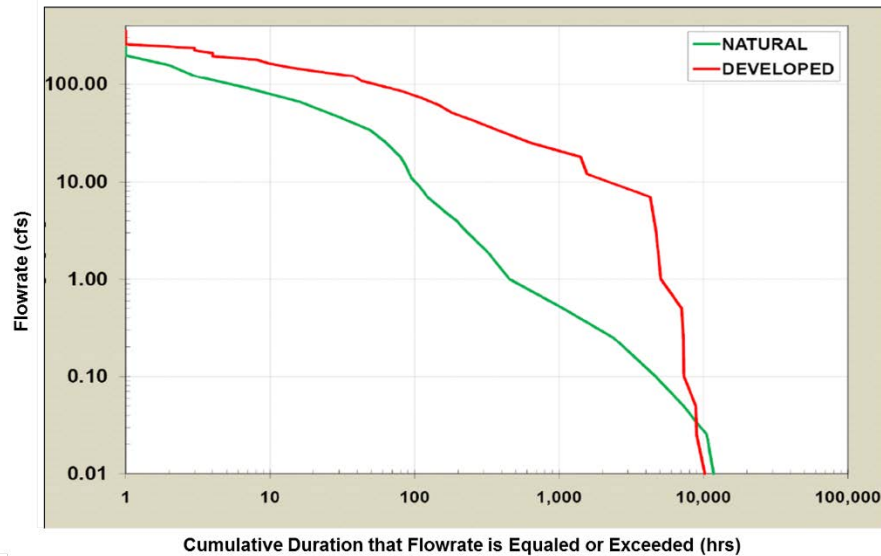

Figure H.8-4: Example Flow Duration Curve

### Scaling Factor for Project-Scale Modeling

Project-scale flow rates derived from continuous hydrologic simulation can be scaled using the ratio of the pre-development 2-year peak discharge for the watershed and project catchment (i.e.,  $Q_2$  watershed /  $Q_2$  project catchment) so that hydraulic and effective work calculations can be performed at the point of compliance with a larger tributary watershed. This scaling translates the runoff from the project catchment to its contribution to erosivity in the down gradient receiving channel, without the need for a complex watershed-scale continuous hydrologic model.

Applicant can estimate the scaling factor using Equation H.8.3. The scaling factor equation was developed using the 2-year peak flow rate empirical equation from Hawley and Bledsoe (2011) and removing the terms (average annual precipitation and imperviousness (pre-development condition as required by the MS4 Permit) that are constant.

### Equation H.8-3: Scaling Factor

$$\text{Scaling Factor} = \left( \frac{A_{\text{watershed}}}{A_{\text{project}}} \right)^{0.667}$$

Where:

$A_{\text{watershed}}$  = total watershed drainage area at the point of compliance(mi<sup>2</sup>)

$A_{\text{project}}$  = total project drainage area (mi<sup>2</sup>)

## STEP 2: HYDRAULIC ANALYSIS

Hydraulic parameters, such as stage, effective shear stress, and flow velocity, are computed for each designated flow bin using channel geometry and roughness data. Hydraulic calculations can be as simple as using the normal flow equation and obtaining results for the central channel or as complicated as using hydraulic models which account for backwater effects, such as HEC-RAS.

Using the formula for unit tractive force (Chow 1959), effective shear stress is expressed using equation H.8.4

### Equation H.8-4: Effective Shear Stress

$$\tau = \gamma RS$$

Where:

$\tau$  = Effective Shear Stress [lb/ft<sup>2</sup>]

$\gamma$  = Unit Weight of Water [62.4 lb/ft<sup>3</sup>]

R = Hydraulic Radius [ft]

S = Energy Gradient Assumed Equal to Longitudinal Slope [ft/ft].

Normal depth can be estimated using Manning's equation (Equation H.8.5). Several sources provide lists of roughness coefficients for use in hydraulic analysis (Chow, 1959).

### Equation H.8-5: Manning's Equation

$$Q = \frac{1.49AR^{0.67}S^{0.5}}{n} \text{ or } V = \frac{1.49R^{0.67}S^{0.5}}{n}$$

Where:

Q = Peak Flowrate [cfs]

V = Average Flow Velocity [ft/s]

A = Cross-Section Flow Area [ft<sup>2</sup>]

R = Hydraulic Radius [ft] = A/P

P = Wetted Perimeter [ft]

S = Energy Gradient Assumed Equal to Longitudinal Slope [ft/ft]

n = Manning Roughness [unit less]

Channel geometry inputs should be characterized by surveying cross-sections and longitudinal profiles of the active channel at strategic locations. Methods of collecting topographic survey data can range from traditional survey techniques (auto level, cloth tape, and survey rod), to conducting a detailed ground-based LiDAR survey.

### STEP 3: WORK ANALYSIS

Hydraulic results for each flow bin along with the critical bed/bank material strength parameters are input into a work or sediment transport function in order to produce a work or transport rating curve. An example of such a rating curve is provided on Figure H.8-3. The work equations can range from simplistic indices, material-specific sediment transport equations, or more complex functions based on site-calibrated sediment transport rating curves.

- **Simplistic indices:** An acceptable equation for effective work, as stated in the Los Angeles Regional MS4 Permit (LARWQCB, 2012) is expressed using equation H.8.6:

#### Equation H.8-6: Effective Work

$$W = (\tau - \tau_c)^{1.5}V$$

Where:

W = Work [dimensionless];

$\tau$  = Effective Shear Stress [lb/ft<sup>2</sup>];

$\tau_c$  = Critical Shear Stress [lb/ft<sup>2</sup>];

V = Mid-Channel Flow Velocity [ft/s]

- **Material-specific sediment transport equations:** Material specific sediment transport equations are allowed to estimate the sediment transport capacity in the post-project and pre-development condition.
- **Site-calibrated sediment transport curves:** Applicants may have an option to use site-calibrated sediment transport curves. In the future these may be available based on monitoring efforts being performed to support the County of San Diego's Hydromodification Management Plan.

The critical shear stress to be used in equation H.8.6 must be estimated using one of the following:

- Shear stress corresponding to the critical flow rate or low flow threshold ( $Q_c$ ).  $Q_c$  is the flowrate that results in incipient motion of bed or bank material, whichever is least resistant.  $Q_c$  is expressed as a fraction of the pre-development 2-year peak flow. The allowable low flow threshold  $Q_c$  can be estimated as 10%, 30%, or 50% of the pre-development 2-year peak flow ( $0.1Q_2$ ,  $0.3Q_2$ , or  $0.5Q_2$ ) depending on the receiving stream susceptibility to erosion, per SCCWRP Technical Report 606, Field Manual for Assessing Channel Susceptibility (SCCWRP, 2010). If a channel susceptibility assessment is not performed, then the conservative default is a  $Q_c$  equal to  $0.1Q_2$ .
- Bed and bank material can also be characterized through a geomorphic field assessment. For each stream location analyzed, a measure of critical shear stress can be obtained for the weakest bed or bank material prevalent in the channel. For non-cohesive material, a Wolman pebble count or sieve analysis can be used to obtain a grain size distribution, which can be converted to a critical shear stress using empirical relationships or published reference tables. For cohesive material, an in-situ jet test or reference tables are used. For banks reinforced with vegetation, reference tables are generally used. Appropriate references for critical shear stress

## Appendix H: Guidance for Investigation Potential Critical Coarse Sediment Yield Areas

values are provided in ASCE No.77 (1992) and Fischenich (2001). To account for the effects of vegetation density and channel irregularities, the applied shear stress can be partitioned into channel form and bed/bank roughness components. SCCWRP Technical Report 667 also has guidance for estimating critical shear stress.

### STEP 4: CUMULATIVE WORK ANALYSIS

Cumulative work is a measure of the long-term total work or sediment transport capacity performed at a creek location. It incorporates the distribution of both discharge magnitude and duration for the flow rates simulated. The cumulative work analysis must be performed up to the maximum geomorphically significant flow of  $Q_{10}$ . To calculate cumulative work, first multiply the work (from STEP 3) and duration associated with each flow bin (from STEP 1). Then, the total work is obtained by summing the cumulative for all flow bins ( $Q_c$  to  $Q_{10}$ ). This analysis can be expressed as:

#### Equation H.8-7: Cumulative Work

$$W_t = \sum_{i=1}^n W_i \Delta t_i$$

Where:

$W_t$  = Total Work [dimensionless]

$W_i$  = Work per flow bin [dimensionless]

$\Delta t$  = Duration per flow bin [hours]

$n$  = number of flow bins

The distribution of cumulative work, also referred to as a work curve (or work histogram), is helpful in understanding which flow rates are performing the most work on the channel of interest. An example work curve is provided in Figure H.8-5.

Appendix H: Guidance for Investigation Potential Critical Coarse Sediment Yield Areas

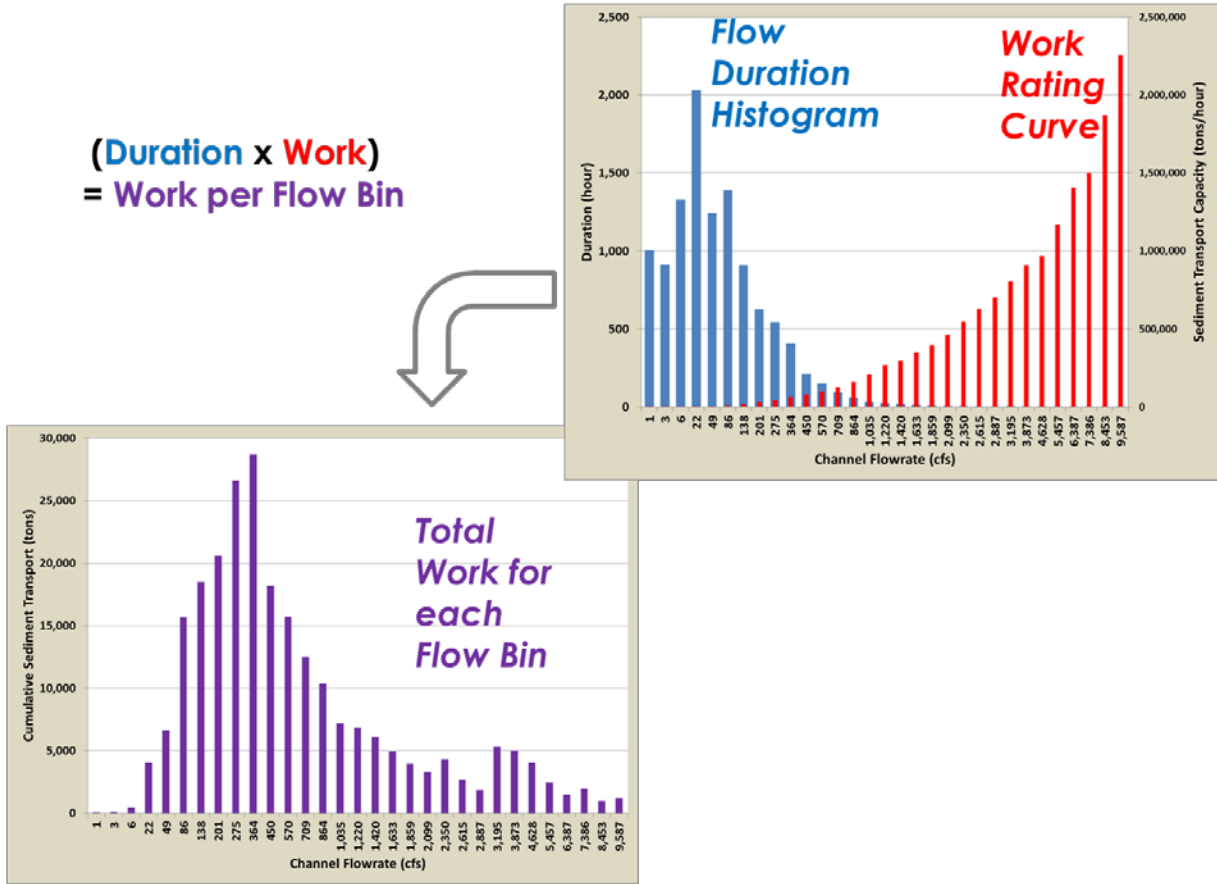

Figure H.8-5 Example Work Curve

## STEP 5: EROSION POTENTIAL ANALYSIS

$E_p$  is calculated by simply dividing the total work of the post-project condition by that of the pre-development (natural) condition.  $E_p$  is expressed as:

### H.8-8: Erosion Potential

$$E_p = W_{t,post} / W_{t,pre}$$

Where:

$E_p$  = Erosion Potential [unitless]

$W_{t,post}$  = Total Work associated with the post-project condition [unitless]

$W_{t,pre}$  = Total Work associated with the pre-development condition [unitless]

As applicable, the applicant must use Worksheet H.8-1 and H.8-2 to document the  $E_p$  calculations for each point of compliance.



## Appendix H: Guidance for Investigation Potential Critical Coarse Sediment Yield Areas

Erosion Potential (Ep) Analysis		Worksheet H.8-1	
Background Information			
1	Low Flow Threshold: results of SCCWRP channel susceptibility analysis (Select $0.1*Q_2$ if analysis has not been performed).	<input type="checkbox"/> $0.1*Q_2$ <input type="checkbox"/> $0.3*Q_2$ <input type="checkbox"/> $0.5*Q_2$	
2	Selected Ep Method	<input type="checkbox"/> Simplified Ep Method <input type="checkbox"/> Standard Ep Method	
2	Hydrologic Analysis: Select hydrologic analysis method.	<input type="checkbox"/> Project-Scale <input type="checkbox"/> Project-Scale and Watershed-Scale Continuous Simulation	
4	Number of Points of Compliance (Copy and complete worksheet for each Point of Compliance)		unitless
Step 1: Hydrologic Analysis (not applicable for Simplified Ep Method)			
5	Project-Scale $Q_2$ (from continuous simulation)		cfs
6	Project Area draining to the point of compliance		sq. miles
7	Watershed Area draining to the point of compliance		sq. miles
8	Scaling Factor for Flows (Line 7/Line 6) <sup>0.667</sup>		unitless
9	Low flow threshold (factor from Line 1 x Line 6)		cfs
10	Watershed-Scale $Q_{10}$ at Point of Compliance (from continuous simulation or Project $Q_{10}$ * Line 8)		cfs
	Hydrologic analysis results (Attach results of continuous simulation including: full pre-development runoff time series at POC, full post-development runoff time series at POC, and flow duration histogram and/or cumulative flow duration curve for each POC).	<input type="checkbox"/> Yes <input type="checkbox"/> No	
Step 2: Hydraulic Analysis (not applicable for Simplified Ep Method)			

**Appendix H: Guidance for Investigation Potential Critical Coarse Sediment Yield Areas**

Erosion Potential (Ep) Analysis		Worksheet H.8-1	
11	Provide details about the cross-section (width, depth, slope, roughness, etc.)		
Step 3: Work Analysis (not applicable for Simplified Ep Method)			
12	Select work index, equation, or transport curve method for use in work analysis.	<input type="checkbox"/> Equation H.8.6 <input type="checkbox"/> Sediment Transport Equation <input type="checkbox"/> Sediment Transport Curve <input type="checkbox"/> Other: _____	
13	Describe/Justify selection in Line 12 above:		
14	Calculate work done for each flow bin under the pre-development and post-project condition using Worksheet H.8-2. Or similar documentation for sediment transport modeling or transport curve analysis.	<input type="checkbox"/> Yes <input type="checkbox"/> No	
Step 4: Cumulative Work Analysis			
14	Cumulative pre-development work (Equation H.8-1 for Simplified Ep Method) (from Worksheet H.8-2 for Standard Ep Method)		
15	Cumulative post-project work (Equation H.8-1 for Simplified Ep Method) (from Worksheet H.8-2 for Standard Ep Method)		
Step 5: Erosion Potential Analysis			
16	Erosion Potential ( Line 15 / Line 14 )		unitless

## Appendix H: Guidance for Investigation Potential Critical Coarse Sediment Yield Areas

Work Calculations (Supplement to Worksheet H.8-1)									Worksheet H.8-2	
1	Channel Slope							(ft/ft)		
2	Channel Roughness (n)							(unitless)		
3	Low Flow Threshold (Line 9 from Worksheet H.8-1)							cfs		
4	Critical Shear Stress							(lb/ft <sup>2</sup> )		
A	B	C	D	E	F	G	H	I	J	K
Bin	Flow (cfs)			Duration (hours)		Hydraulic Radius (ft)	Average Velocity (ft/s)	Shear Stress (lb/ft <sup>2</sup> )	Work (unitless)	
	Lower Limit	Upper Limit	Average	Pre-development	Post-Project				Pre-development	Post-Project
1										
2										
3										
4										
5										
6										
7										
8										
9										
10										
11										
12										
13										
14										
15										
16										
17										
18										
19										
20										
n										
Sum (Bins 1 to n) =										

## Appendix H: Guidance for Investigation Potential Critical Coarse Sediment Yield Areas

### Worksheet H.8-2 Key

- A** Number of flow bins, add additional rows as needed
- B** Lower limit for the corresponding flow bin
- C** Upper limit for the corresponding flow bin
- D** Average flow for the corresponding flow bin;  $[(\mathbf{B} + \mathbf{C})/2]$
- E** Duration in hours for the corresponding flow bin in pre development condition
- F** Duration in hours for the corresponding flow bin in post project condition
- G** Hydraulic radius (in feet) associated with the average flow for the corresponding flow bin (from Manning's equation and/or hydraulic analysis)
- H** Average flow velocity (in fps) associated with the average flow for the corresponding flow bin (from Manning's equation and/or hydraulic analysis)
- I** Shear stress (lb/ft<sup>2</sup>) associated with the average flow for the corresponding flow bin =  $\gamma * \text{Hydraulic Radius} * \text{Slope} = 62.4 * \mathbf{G} * \text{Line 1}$
- J** Pre-development work for associated flow bin  
 $\mathbf{J} = 0$ ; If  $(\mathbf{I} - \text{Line 4}) \leq 0$   
 $\mathbf{J} = \mathbf{E} * (\mathbf{I} - \text{Line 4})^{1.5} * \mathbf{H}$ ; If  $(\mathbf{I} - \text{Line 4}) > 0$
- K** Post-project work for associated flow bin  
 $\mathbf{K} = 0$ ; If  $(\mathbf{I} - \text{Line 4}) \leq 0$   
 $\mathbf{K} = \mathbf{F} * (\mathbf{I} - \text{Line 4})^{1.5} * \mathbf{H}$ ; If  $(\mathbf{I} - \text{Line 4}) > 0$

**Note:** If the receiving water dimensions are different in pre-development and post-project condition then Worksheet H.8-2 is not valid for work calculations.

## Appendix H: Guidance for Investigation Potential Critical Coarse Sediment Yield Areas

### H.8.2 Calculation of Sp

While there are many categories of erosion processes (e.g., landslides, debris flows, gullies, tree throw, animal burrows, sheetwash erosion, wind erosion, dry ravel, bank erosion), in this evaluation processes will be simplified to sediment production from hillslopes and channels. Under ideal circumstances, the total bed sediment supply rate (tons/year) would be calculated for both the post-project buildout condition and pre-project condition using a watershed-scale Geomorphic Landscape Unit (GLU) and Geomorphic Channel Unit (GCU) approach which:

- (1) identifies different sources of sediment supply based on categories of terrain slope, geology, land cover, and stream order;
- (2) estimates the base erosion rate of those sources (GLUs and GCUs);
- (3) approximates the sediment delivery ratio (SDR) to the receiving channel;
- (4) evaluates the coarse bed-load fraction of the sources; and
- (5) integrates these considerations into a bed-load yield rate for both the existing condition and proposed buildout condition.

However, calculation of sediment yield rates for each GLU (tons/mi<sup>2</sup>-yr) and GCU (tons/mi-yr) using the available science is inherently inexact and requires extensive field calibration. Additionally, performing the geospatial calculations necessary for such a comprehensive GLU and GCU analysis may not be straightforward for some project applicants. Since the objective is to determine the fraction of reduction in bed sediment supply in the post-project condition compared to the pre-project condition, but not to determine the bed sediment yield in physical units (tons/year/acre, for example) the following simplifications are allowed. These simplifications take into consideration the regional sediment yield map shown in Figure H.8-6.

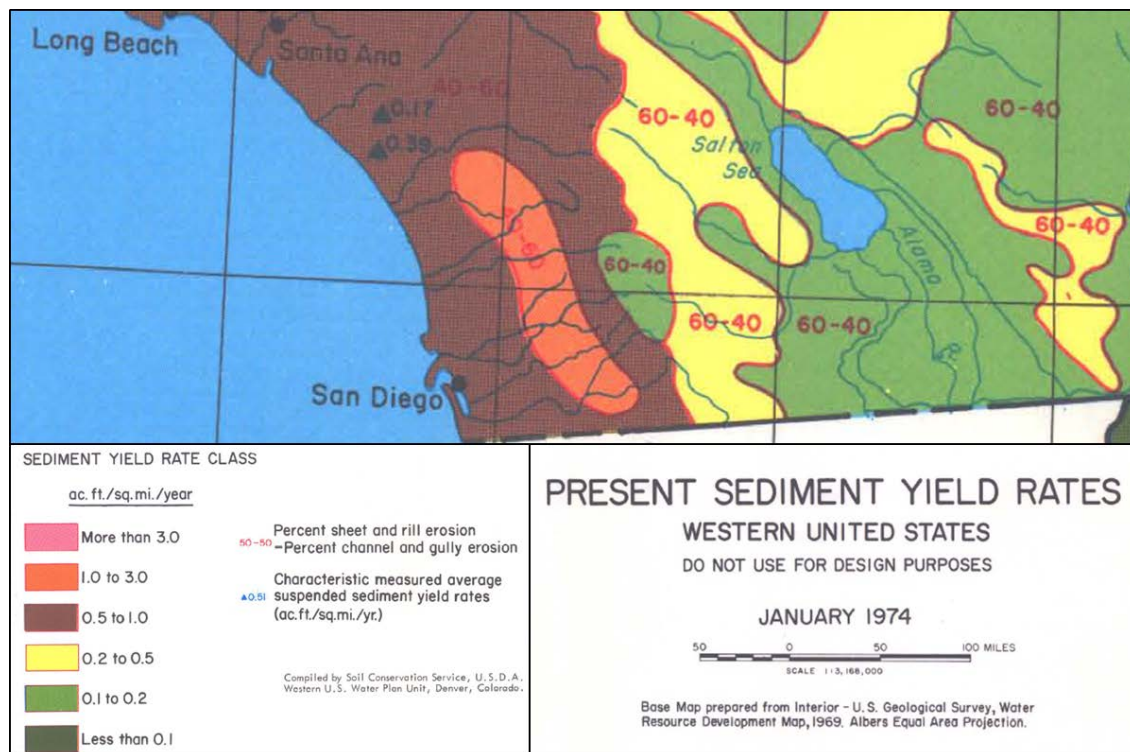

## Appendix H: Guidance for Investigation Potential Critical Coarse Sediment Yield Areas

### Figure H.8-6 Regional Sediment Yield Map

According to a regional sediment yield map of the Western US (USDA, 1974), hillslope processes (sheet and rill erosion) account for approximately 40% of the sediment yield in the San Diego County region, while channel processes (in-stream and gully erosion) account for approximately 60% of the sediment yield. Figure H.8-7 shows the different erosion processes. Provision E.3.a.(3)(a) of the MS4 Permit requires, “maintenance or restoration of natural storage reservoirs and drainage corridors (including topographic depressions, areas of permeable soils, natural swales, and ephemeral and intermittent streams)”, effectively making maintenance or restoration of channels and gullies within a project site a site design requirement.

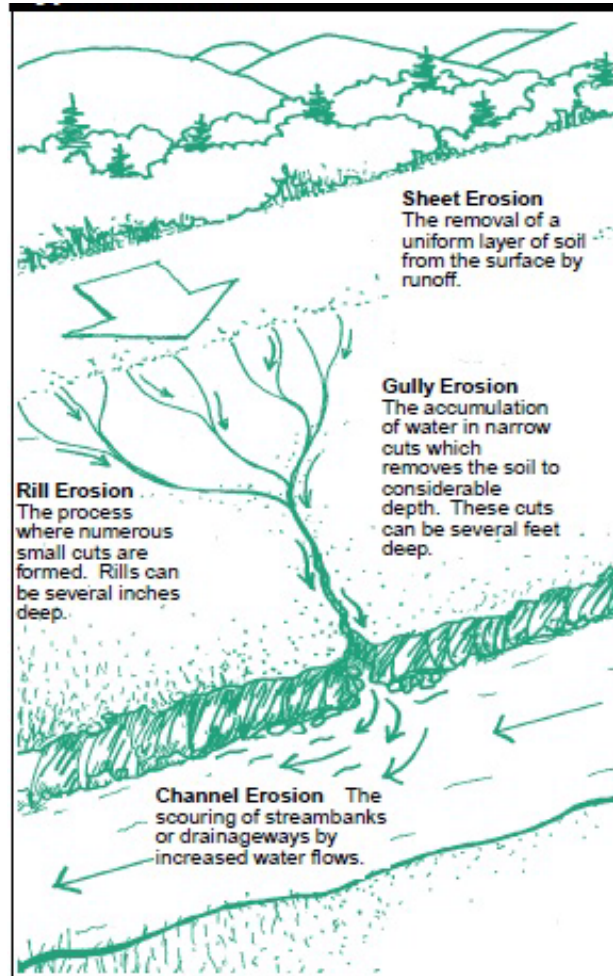

Figure H.8-7 Different Erosion Processes that Contribute Sediment

Source: <http://www.fairfaxcounty.gov/nvswcd/youyourland/soil.htm>

Sediment yield from hillslope processes (sheet and rill erosion) can be estimated using the Revised Universal Soil Loss Equation (RUSLE) and a sediment delivery ratio. For channel processes, the best available regional datasets are the USGS National Hydrography Dataset (NHD) and the NHDPlus dataset from USEPA and USGS (<http://www.horizon-systems.com/nhdplus/>). Both these datasets may not include the lowest order channels or gullies in the stream network, which can contribute a

## Appendix H: Guidance for Investigation Potential Critical Coarse Sediment Yield Areas

considerable amount of sediment produced from channel processes. Since the lower order channels and gullies originate and are mostly on the hillslopes, it is assumed for the Sp analysis that the sediment yield from lower order channels and gullies is proportional to the sediment yield from hill slopes. Based on feedback received during the TAC meetings (Appendix H.5.1) the following distribution is proposed for the calculation of Sp:

- 70% of bed sediment yield ratio from RUSLE analysis (assumed to account for sediment yield from hillslope processes (sheet and rill erosion) and channels and gullies not part of the NHDPlus dataset); and
- 30% of bed sediment yield ratio from channels in the NHDPlus dataset.

### Note:

- If an applicant elects to map the waters of the state, the Sp distribution shall be revised to
  - 40% of bed sediment yield ratio from RUSLE analysis;
  - 30% of bed sediment yield ratio from waters of the state that are not part of NHDPlus dataset; and
  - 30% of bed sediment yield ratio from channels in the NHDPlus dataset.

## SCALE OF ANALYSIS

The project applicant shall perform the Sp analysis at point (or points) where runoff leaves the project site. The steps for performing an Sp analysis are shown in Figure H.8-8 and described below.

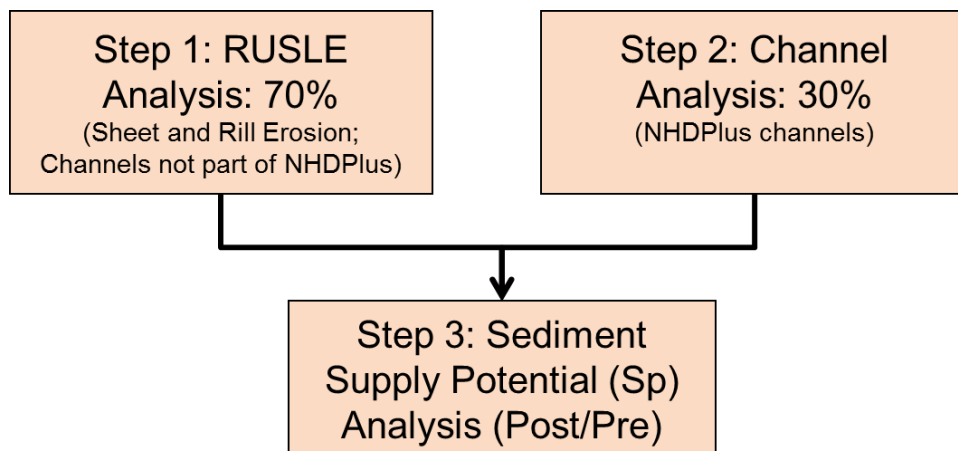

Figure H.8-8 Sediment Supply Potential Flow Chart

## STEP 1: RUSLE ANALYSIS

RUSLE analysis is assumed to account for sediment yield from hillslope processes (sheet and rill erosion) and channels and gullies not part of the NHDPlus dataset. The change in bed sediment yield in the post-project condition compared to the pre-project condition using the RUSLE analysis must be estimated using equation H.8-9. This equation is a modified form of the standard RUSLE equation. Only hillslopes that are anticipated to generate coarse sediment must be used in this analysis. Since

## Appendix H: Guidance for Investigation Potential Critical Coarse Sediment Yield Areas

Sp is a dimensionless index the terms that are relatively constant in the pre and post project condition, such as rainfall factor, have been removed.

### H.8-9: Sediment Yield (Hillslope)

$$SY_{RUSLE} = \frac{\text{Post} - \text{Project} \sum\{A \times K \times LS \times C \times P\}}{\text{Pre} - \text{Project} \sum\{A \times K \times LS \times C\}}$$

Where:

A = Hillslope Area (acres)

K = Soil erodibility factor, this value can be obtained from regional K factor map from SWRCB or web soil survey or site-specific grain size analysis

LS = Slope length and steepness factor, this value can be obtained from the regional LS factor map from SWRCB or site-specific determination using look up tables based on slope and horizontal slope length from USDA Agriculture Handbook Number 703 (Renard et al., 1997) or other relevant sources

C= Cover management factor, use regional C factor map from USEPA or site-specific information; this is the reciprocal of the amount of surface cover on soil, whether it be vegetation, temporary mulch or other material. It is roughly the percentage of exposed soil, i.e., 95 percent cover yields a “C” value of 0.05. Use C=0 for areas where management actions are implemented (e.g. impervious areas) or where the project proposes any significant grading activities.

The applicant may be allowed to receive credit for bed sediment yield from engineered slopes on the project perimeter directly discharging to conveyance systems if **All** of the following criteria are met:

- The engineer slopes are made up of coarse bed material. This is confirmed by performing grain size distribution per ASTM D422 for the engineered slope and verifying that the d<sub>50</sub> is greater than no. 200 sieve (0.074 mm).
- Cover factor in the post project condition is not be greater than the cover factor used in the pre project condition for the same area.
- A maximum practice factor of 0.25 is applied to proposed fill slopes. A maximum practice factor of 0.50 is applied to proposed cut slopes.
- A statement from the geotechnical engineer is included in the SWQMP certifying that the engineered slope will be stable even after accounting for bed sediment generation and the anticipated soil loss during the planned lifetime of the engineered slope is acceptable.

Additional analysis and/or documentation may be requested by the City Engineer prior to approval of the credit for bed sediment yield from engineered slopes.



## STEP 2: CHANNEL ANALYSIS

If an NHDPlus mapped channel exists within the project property boundary, applicants must consider the sediment production from this existing channel system. The change in bed sediment yield in the post-project condition compared to the pre-project condition from channels in the NHDPlus dataset must be estimated using Equation H.8-10 (SYNHD). This equation is based on screening-level GIS calculations of stream length that will be contributing sediment in the post-project condition in the watershed tributary to the point of compliance.

### Equation H.8-10: Sediment Yield (NHD)

$$SY_{NHD} = \frac{L_{post}}{L_{pre}}$$

Where:

$L_{post}$  = Length of NHDplus streams in the watershed contributing to bed sediment supply in the post-project condition [miles]

$L_{pre}$  = Length of NHDplus streams in the watershed contributing to bed sediment supply in the pre-project existing condition [miles]

## STEP 3: SEDIMENT SUPPLY POTENTIAL ANALYSIS

Sediment Supply Potential ( $S_p$ ) is defined as the ratio of post-project/pre-project (existing) long-term bed sediment supply.  $S_p$  must be calculated using equation H.8-11 presented below:

### Equation H.8-11: Sediment Supply Potential

$$S_p = 0.7 \times SY_{RUSLE} + 0.3 \times SY_{NHD}$$

Where:

$S_p$  = Sediment Supply Potential [unitless]

$SY_{RUSLE}$  = Change in bed sediment yield from hillslopes and lower order channels and gullies not part of NHDPlus dataset [unitless]

$SY_{NHD}$  = Change in bed sediment yield from channels in NHDPlus dataset [unitless]

When estimating  $S_p$  the following additional conditions apply:

- Projects that do not have onsite NHDPlus channels shall omit consideration of SYNHD and weighting factors depicted in Equation H.8-11. This simply results in  $S_p = SY_{RUSLE}$ .
- It must be assumed that the sediment yield from an area that drains to a structural BMP is zero. Consideration of sediment yield from an area draining to the structural BMP may be

## **Appendix H: Guidance for Investigation Potential Critical Coarse Sediment Yield Areas**

allowed if sediment bypass measures are implemented upstream of the structural BMP. However, additional analysis may be requested by the City Engineer to substantiate the sediment yield estimates proposed by the applicant from implementing sediment bypass measures.

- For scenarios where an upstream coarse sediment yield area drains through the project footprint and the project footprint cuts off conveyance of bed sediment generated upstream of the project footprint to the point of compliance, (e.g., via debris basins) the contribution from the upstream area shall be assumed to be zero.

As applicable, the applicant must use Worksheet H.8-3 to document the Sp calculations for each point of compliance.

**Appendix H: Guidance for Investigation Potential Critical Coarse Sediment Yield Areas**

Sediment Supply Potential (Sp) Analysis							Worksheet H.8-3					
1	Scale of Analysis					<input type="checkbox"/> Project Scale <input type="checkbox"/> Watershed Scale (build-out condition)						
Step 1: RUSLE Analysis												
2	GLU	Pre-Project					Post-Project					
		A	K	LS	C	A*K*LS*C	A	K	LS	C	P	A*K*LS*C*P
	1											
	2											
	3											
	4											
	5											
	6											
	7											
	8											
Add additional rows as needed												
3	Sum Pre-Project					Sum Post-Project						
4	$SY_{RUSLE} = (\text{Sum Post-Project} / \text{Sum Pre-Project})$ (From Line 3)										unitless	
Step 2: Channel Analysis: NHDPlus Channels												
5	$L_{pre}$ (from GIS analysis of pre-project existing condition)										miles	
6	$L_{post}$ (from GIS analysis of post-project condition)										miles	
7	$SY_{NHD} = (\text{Line 6} / \text{Line 5})$										unitless	
Step 3: Sediment Supply Potential Analysis												
8	RUSLE Analysis Bed Sediment Yield Ratio Calculated ( Line 4 )										unitless	
9	Channel Bed Sediment Yield Ratio from NHDPlus dataset ( Line 7 )										unitless	
10	Sediment Supply Potential Calculated using Equation H.8.11. ( 0.7 x Line 8 + 0.3 x Line 9 )										unitless	

## Appendix H: Guidance for Investigation Potential Critical Coarse Sediment Yield Areas

This page was intentionally left blank.

## H.9 Mitigation Measures Fact Sheets

The following fact sheets were developed to assist the project applicants with designing mitigation measures:

- Additional flow control
- Stream Rehabilitation

## Appendix H: Guidance for Investigation Potential Critical Coarse Sediment Yield Areas

This page was intentionally left blank.

H.9.1 Additional flow control

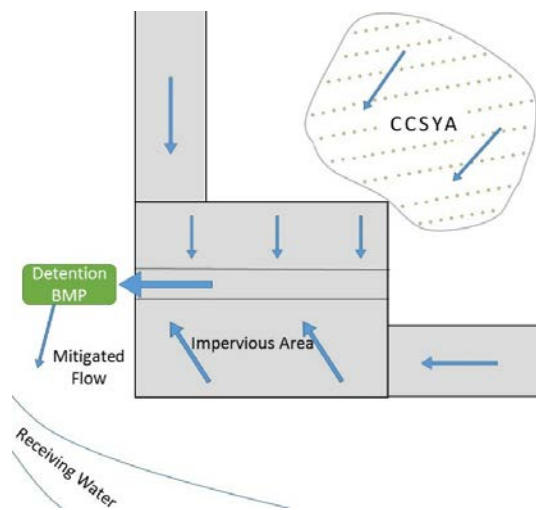

**Description**

Additional flow control refers to the modification of post-development flow rates and durations beyond the levels required by standard HMP criteria (i.e. control of flow rates and durations from  $Q_c$  to  $Q_{10}$ ). Additional flow control can mitigate the effect of decreased sediment delivery by equivalently limiting sediment transport capacity. BMPs providing additional flow control are detention/retention type BMPs and will typically be larger than those that meet HMP criteria only. The performance standard for additional flow control can be demonstrated through the NII management standard.

**Management Standard and Sizing Approach**

The management standard additional flow control BMPs need to meet to demonstrate that there is no net impact to the receiving waters is presented in the equation below:

$$NII = \frac{Ep}{Sp} \leq 1.1$$

Where:

$Ep$ : is the ratio of post-project/pre-development sediment transport capacity

$Sp$ : ratio of post-project/pre-project (existing) long-term bed sediment supply

**Note:** Redevelopment projects typically do not have critical coarse sediment yield areas onsite because management actions have been implemented onsite (e.g. impervious areas, etc.). Refer to Appendix H.8 for methodologies to calculate  $Ep$  and  $Sp$ .

Project applicants must demonstrate that the NII management standard will be met under the post-project scenario through the following steps:

1. Calculate the  $Sp$  at the point of compliance using guidance in Appendix H.8.2.

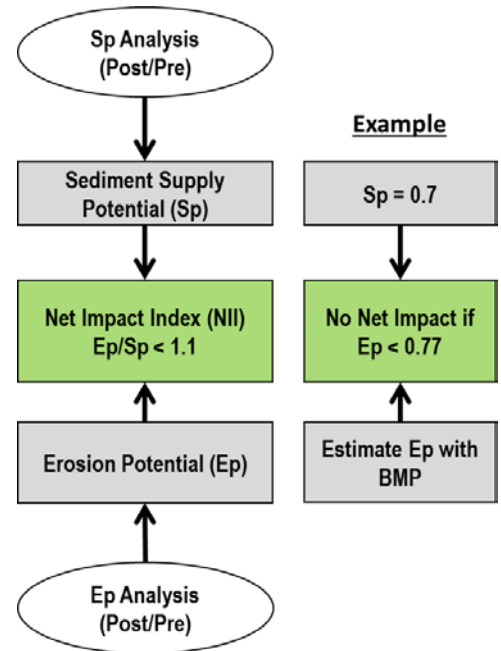

## Appendix H: Guidance for Investigation Potential Critical Coarse Sediment Yield Areas

2. Determine the Target  $E_p$ :  $E_{p\text{Target}} \leq 1.1 * S_p$
3. Calculate the pre-development sediment transport capacity or work ( $E_p$  denominator). Refer to Section 6.3.3 for definition of pre-development and refer to Appendix H.8.1 for guidance on calculating the sediment transport capacity or work.
4. Iteratively size additional flow control BMPs and calculate the post-project sediment transport capacity ( $E_p$  numerator) until the target  $E_p$  is reached.
5. Summarize the calculations performed to size the BMPs in the SWQMP.

In addition to the general approach outlined above, additional flow control BMPs must meet the design criteria presented in the Model BMP Design Manual (refer to Appendix E Fact Sheets). Deviations from these criteria may be approved at the discretion of the City Engineer if it is determined appropriate

### Design Adaption for Project Goals

**NII management standard is met by additional flow control.** Larger BMPs may be able to provide adequate additional flow control to meet the required performance standard. In this scenario no additional sediment BMPs are required.

For example, project that has an  $S_p = 0$  (i.e. 100% of the bed sediment in the drainage area to the point of compliance is impacted by the project) can be mitigated by designing a BMP such that there is no discharge within the geomorphically significant flow range (i.e.  $Q_c$  to  $Q_{10}$ ).

**NII management standard is not fully met by additional flow control.** Additional flow control alone may not be able to entirely meet the NII management standard due to site, or other, constraints. In scenarios where the target  $E_p$  cannot be met by additional flow control, additional BMPs that increase the supply of bed sediment or reduce the susceptibility of the receiving channel will be required.

**Note:** Additional flow control BMPs can be independent BMPs that provide flow control only or they can be integrated with storm water pollutant control BMPs.

### Conceptual Design and Sizing Approach

The following steps detail an approach that can be used to appropriately size BMPs that provide additional flow control:

**Step 1: Calculate the Sediment Supply Potential ( $S_p$ ) based on pre- and post-project condition at the point of compliance.**

- Refer to Appendix H.8.2 for methodology to calculate  $S_p$ . Applicant must document this analysis using Worksheet H.8-3.

**Step 2: Determine the Target  $E_p$  based on the results of Step 1.**

- $E_{p\text{Target}} \leq 1.1 * S_p$

**Step 3: Perform continuous simulation modeling for pre-development condition.**

- Perform continuous simulation (refer to Appendix G) for the pre-development condition.



## Appendix H: Guidance for Investigation Potential Critical Coarse Sediment Yield Areas

- Determine the flow durations for the pre-project scenario as described in Appendix G.1.6.2.

### Step 4: Perform pre-development work analysis.

- Calculate the cumulative work performed by the range of geomorphically significant flows for the pre-development scenario, (refer to Step 3 and Step 4 in Appendix H.8.1 for calculation of work).

### Step 5: Implement flow control BMPs and perform continuous simulation modeling for post-project scenario.

- Appropriately size pollutant control and hydromodification management BMPs according to the procedures presented in this manual.
- Perform continuous simulation (refer to Appendix G) for the post-project condition.
- Determine the flow durations for the post-project scenario as described in Appendix G.1.6.2.
- Typically, BMPs sized to satisfy the flow duration control will provide for some level of  $S_p$  reduction and will ensure that the minimum design standards and sizing requirements are met.

### Step 6: Perform post-project work analysis.

- Follow the steps presented in Step 4 to determine the post-project total work.

### Step 7: Calculate $E_p$ and determine if Target $E_p$ has been met.

- Divide the post-project total work by the pre-development total work and determine if the target  $E_p$  has been met.
- If the target  $E_p$  is met by the standard BMPs, document results and compliance with hydrologic and sediment supply performance standards.
- If the target  $E_p$  is not met, proceed to Step 8.

### Step 8: Provide additional flow control storage and calculate $E_p$ .

- Following the procedures presented in the previous steps, iteratively calculate  $E_p$  for increasingly large BMPs until the target  $E_p$  is met.
- Document results and compliance with hydrologic and NII management standard.

As applicable, the applicant must use Worksheet H.8-1, Worksheet H.8-3 and Worksheet H.9-1 to document sizing of the additional flow control mitigation measure.

## Appendix H: Guidance for Investigation Potential Critical Coarse Sediment Yield Areas

This page was intentionally left blank.

**Appendix H: Guidance for Investigation Potential Critical Coarse Sediment Yield Areas**

Additional Flow Control Mitigation Measure		Worksheet H.9-1	
1	Sediment Supply Potential (Line 10 of Worksheet H.8-3)		unitless
2	Attached completed Worksheet H.8-3 and associated documentation	<input type="checkbox"/> Yes <input type="checkbox"/> No	
3	Target $E_p \leq 1.1 * \text{Line 1}$		unitless
4	Erosion Potential (Line 16 of Worksheet H.8-1)		unitless
5	Attached completed Worksheet H.8-1 and associated documentation	<input type="checkbox"/> Yes <input type="checkbox"/> No	
6	Is $\text{Line 4} \leq \text{Line 3}$ ? If Yes, NII management standard is met. If No, increase the size of the BMP and recalculate Line 4.	<input type="checkbox"/> Yes <input type="checkbox"/> No	

## Appendix H: Guidance for Investigation Potential Critical Coarse Sediment Yield Areas

This page was intentionally left blank.

H.9.2 Stream Rehabilitation

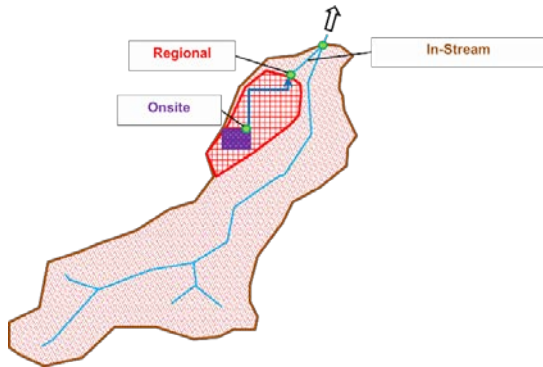

**Description**

Hydromodification control can be achieved by stream rehabilitation projects including: drop structures, grade control structures, bed and bank reinforcement, increased channel sinuosity or meandering, increased channel width, and flow diversion. The objective of these in-stream controls, or stream restoration measures, is to reduce or maintain the overall  $E_p$  of the receiving channel. Stream rehabilitation option is only available when the receiving channel of concern is already impacted by erosive flows and shows evidence of excessive sediment, erosion, deposition, or is a hardened

channel.

**Management Standard and Sizing Approach**

The management standard stream rehabilitation projects need to meet to demonstrate that there is no net impact to the receiving waters is presented in the equation below:

$$NII = \frac{E_p}{S_p} \leq 1.1$$

Where:

$E_p$ : is the ratio of post-project/pre-development sediment transport capacity

$S_p$ : ratio of post-project/pre-project (existing) long-term bed sediment supply

**Note:** Stream rehabilitation project reduce  $E_p$  by modifying the stream’s hydraulic properties and/or bed/bank material resistance without fully replacing sediment supply or controlling increases in runoff. Refer to Appendix H.8 for methodologies to calculate  $E_p$  and  $S_p$ .

**Design Adaption for Project Goals**

The following describes different types of stream rehabilitation projects that could be implemented to meet the NII management standard by reducing or maintaining the overall  $E_p$ :

**Drop Structures:** Drop structures are designed to reduce the average channel slope, thereby reducing the shear stresses generated by stream flows. These controls can be incorporated as natural looking rock structures with a step-pool design which allows drop energy to be dissipated into the pools while providing a reduced longitudinal slope between structures.

**Grade Control Structures:** Grade control structures are designed to maintain the existing channel slope while allowing for minor amounts of local scour. These control measures are often buried and entail a narrow trench across the width of the stream backfilled with concrete or similar material, as well as the creation of a “plunge pool” feature by placing boulders and vegetation on the downstream

## Appendix H: Guidance for Investigation Potential Critical Coarse Sediment Yield Areas

side of the sill. A grade control structure provides a reduced footprint and impact as compared to drop structures, which are designed to alter the channel slope.

**Bed and Bank Reinforcement:** Channel reinforcement serves to increase bed and bank resistance to instream erosion. A number of vegetated approaches are widely used. Such approaches include large woody debris, live crib walls, vegetated mechanically stabilized earth, live siltation, live brushlayering, willow posts and poles, live staking, live fascine, rootwad revetment, live brush mattresses, and vegetated reinforcement mats. These technologies provide erosion control that stabilizes bed and bank surfaces and allows for re-establishment of native plants, which serves to further increase channel stability.

**Channel Sinuosity:** Increasing channel sinuosity (meandering) can serve to reduce the channel slope, thereby reducing the shear stresses generated by stream flows. However, forcing a channel to be too sinuous is likely to lead to subsequent channel avulsion (cutting a new stream path) to a straighter course. Channel sinuosity needs to be supported by a geomorphic basis of design that shows the proposed form and gradient are appropriate for the valley slope, sediment, and water regime. This support may take the form of reference reaches in similar watersheds that have supported the proposed morphology over a significant period of time, or comparison between the proposed form and typical literature values.

**Channel Widening:** Increasing the width-to-depth ratio of a stream's cross section is meant to spread flows out over a wider cross section with lower depths, thereby reducing shear stress for a given flow rate. This approach can be a useful management strategy in incised creeks to restore them to equilibrium conditions once vertical incision has ceased. As with sinuosity, it is important to develop a robust geomorphic basis of design that shows the increase in width-to-depth ratio to be sustainable.

**Flow Diversion:** Flow diversions can be designed to divert the excess flows caused by development to an hydromodification management exempt water body so that the shear stresses do not increase in the susceptible receiving water. When diversions are proposed to a water body exempt through watershed management area analysis, the applicant is required to provide a supporting analysis that the excess flows diverted to the exempt water body do not invalidate the exemption.

### Design Considerations

Each stream rehabilitation project is to some degree unique because of differences in geomorphic process, morphology and previous watershed history. For this reason, this fact sheet does not provide a prescriptive 'cookery book' approach for rehabilitating streams, but instead provides guidelines and recommendations. Shields (1996) provides a helpful overview of the analytical steps involved in stream restoration and Shields et al. (1999) provides examples of approaches used to rehabilitate incised channels. Applicant will need to provide geomorphic and engineering information to support their proposed project approach. It is recommended that multiple lines of technical evidence be used by applicants to develop creek restoration plans based on the preponderance of evidence for design criteria such as channel width, depth, slope and planform. It is also important to understand that all creek rehabilitation projects must comply with relevant Federal, State and local regulations and permits. These will likely include obtaining permits from the RWQCB, USACE and California DF&W, and may involve additional permits or consultation with USDF&W and FEMA, as well as permits from the local jurisdiction. The proposed design shall also meet local drainage design guidelines for channel design.

ESCONDIDO STORM WATER DESIGN MANUAL

# Forms and Checklists

# Appendix I Forms and Checklists

The following Forms/Checklists/Worksheets were developed for use by the project applicant to document the storm water management design:

- I-1a: Storm Water Standard Development Project Submittal
- I-1b: Storm Water and Development Projects Fact Sheet (Minor Project)
- I-2A: Site Information Checklist for PDPs
- I-2B: Source Control BMP Checklist for All Development Projects
- I-2C: Site Design BMP Checklist for All Development Projects
- I-3: Summary of PDP Structural BMPs
- I-7: Harvest and Use Feasibility Screening Checklist
- I-8: Categorization of Infiltration Feasibility Condition
- I-9: Factor of Safety and Design Infiltration Rate
- I-10: Compact (High-Rate) Biofiltration BMP Checklist
- I-11: Determination of Downstream System Requirements for Preservation of Coarse Sediment Supply



<b>Form I-1a: Storm Water Standard Development Project Submittal</b>		<b>Form I-1a</b>
<b>Project Information &amp; Certification</b>		
<b>Project Name:</b>		<b>Project ID:</b>
Project Address:		
Assessor's Parcel Number:		
Applicant Name:		
Applicant Company:		
Applicant Address:		
Applicant Phone Number:		
Applicant Email Address:		
Project Description:		
<b>STORM WATER BEST MANAGEMENT PRACTICES REQUIRED BY PROJECT TYPE</b>		
<b>MINOR</b>	<b>STANDARD</b>	<b>PRIORITY</b>
<ul style="list-style-type: none"> <li>•Construction BMPs</li> </ul>	<ul style="list-style-type: none"> <li>•Construction BMPs</li> <li>•Site Design BMPs</li> <li>•Source Control BMPs</li> </ul>	<ul style="list-style-type: none"> <li>•Construction BMPs</li> <li>•Site Design BMPs</li> <li>•Source Control BMPs</li> <li>•Structural BMPs</li> </ul>

I certify that the BMPs documented in this Form will be implemented and maintained in the above-referenced project.

Name	Signature	Date
<input type="checkbox"/> Property Owner	<input type="checkbox"/> Property owner's authorized representative	

Form I-1a: Storm Water Standard Development Project Submittal		Form I-1a
Part I: Storm Water Project Definitions		
Project Name:		Project ID:
Yes	No	Check "yes" or "no" to find your project type
		1 New development projects that create 10,000 square feet or more of impervious surfaces (collectively over the entire project site). This includes commercial, industrial, residential, mixed use, and public development projects on public or private land.
		2 Redevelopment projects that create and/or replace 5,000 square feet or more of impervious surfaces (collectively over the entire project site on an existing site of 10,000 square feet or more of impervious surfaces). This includes commercial, industrial, residential, mixed use, and public development projects on public or private land.
		3 New or redevelopment projects that create and/or replace 5,000 square feet or more of impervious surface (collectively over the entire project site) and support one or more of the following uses:
		3a Restaurants: includes stationary lunch counters and refreshment stands selling prepared foods & drinks for immediate consumption (SIC Code 5812).
		3b Hillside development: includes development on natural slopes 25% or greater.
		3c Parking lots: includes the temporary parking or storage of motor vehicles used personally, for business, or for commerce.
		3d Streets, roads, highways, freeways and driveways: includes any paved impervious surface used for the transportation of automobiles, trucks, motorcycles and other vehicles.
		4 New or redevelopment projects that create and/or replace 2,500 square feet or more of impervious surface (collectively over the entire project site) and discharges directly to an Environmentally Sensitive Area (ESA). "Discharging directly to" includes flow that is conveyed overland a distance of 200 feet or less from the project to the ESA, or conveyed in a pipe or open channel any distance as an isolated flow from the project to the ESA (i.e. not commingled with flows from adjacent lands).
		5 New development projects, or redevelopment project that create and/or replace 5,000 square feet or more of impervious surface, that support one or more of the following uses:
		5a Automotive repair shops: includes a facility that is categorized in any one of these SIC Codes: 5013, 5014, 5541, 7532-7534, 7536-7539.
		5b Retail gasoline outlets (RGOs): includes RGOs that meet the following criteria: (a) 5,000 square feet or more or (b) a projected Average Daily Traffic (ADT) of 100 or more vehicles per day.
		6 New or redevelopment projects that result in the disturbance of one or more acres of land and are expected to generate pollutants post-construction.
A "yes" in <u>any</u> category above requires Priority Development Project (PDP) submittal. <b>STOP HERE.</b> Prepare a Storm Water Quality Management Plan (SWQMP).		
A "no" in <u>all</u> the categories above shows you are a Standard project or a Minor project. Review the Minor project information sheet. If a Minor project, no forms are required. If a Standard project, continue filling in Parts II and III of this form - Site Design BMPs and Source Control BMPs.		

Form I-1a: Storm Water Standard Development Project Submittal Part 2: Site Design BMPs (Low Impact Development – LID)		Form I-1a
Project Name:	Project ID:	
The following checklists serve as guides only. Mark what elements are included in <b>your</b> project. See Storm Water Design Manual Chapter 4 and Appendix E for more information on determining appropriate BMPs for <b>your</b> project.		
Maintain Natural Drainage Pathways and Hydrologic Features (SD-1)		
<input type="checkbox"/> Maintain existing drainage patterns <input type="checkbox"/> Other _____ <input type="checkbox"/> N/A or Infeasible (explanation) _____		
Conserve Natural Areas, Soils and Vegetation (SD-2)		
<input type="checkbox"/> Preserve trees (see Zoning Code Art. 55 Grading & Erosion Control; Art. 62 Landscape Regulations) <input type="checkbox"/> Avoid sensitive areas such as wetlands and waterways <input type="checkbox"/> Other _____ <input type="checkbox"/> N/A or Infeasible (explanation) _____		
Minimize Impervious Area (SD-3)		
<input type="checkbox"/> Install parking and driving aisles to minimum width required to meet standards <input type="checkbox"/> Other _____ <input type="checkbox"/> N/A or Infeasible (explanation) _____		
Minimize Soil Compaction (SD-4)		
<input type="checkbox"/> Avoid compaction in planned landscaped spaces <input type="checkbox"/> Till and amend soil for improved infiltration capacity <input type="checkbox"/> Other _____ <input type="checkbox"/> N/A or Infeasible (explanation) _____		
Impervious Area Dispersion (SD-5)		
<input type="checkbox"/> Drain rooftops, roads or sidewalks into adjacent landscape areas <input type="checkbox"/> Drain impervious surfaces through pervious areas <input type="checkbox"/> Other _____ <input type="checkbox"/> N/A or Infeasible (explanation) _____		
Runoff Collection (SD-6)		
<input type="checkbox"/> Use small collection points distributed throughout the site <input type="checkbox"/> Locate collection points as close to the source as possible <input type="checkbox"/> Other _____ <input type="checkbox"/> N/A or Infeasible (explanation) _____		
Landscaping with Native or Drought Tolerant Species (SD-7)		
<input type="checkbox"/> Choose plants that require minimal irrigation, fertilizers and pesticides <input type="checkbox"/> For guidance, see plant list in Appendix E and Zoning Code Article 62 Landscape Regulations <input type="checkbox"/> Other _____ <input type="checkbox"/> N/A or Infeasible (explanation) _____		
Harvesting and Using Precipitation (SD-8)		
<input type="checkbox"/> Install rain barrels <input type="checkbox"/> Other _____ <input type="checkbox"/> N/A or Infeasible (explanation) _____		

<b>Form I-1a: Storm Water Standard Development Project Submittal</b> <b>Part 3: Source Control BMPs</b>		<b>Form I-1a</b>
<b>Project Name:</b>	<b>Project ID:</b>	
<p>The following checklists serve as guides only. Mark what elements are included in <b>your</b> project. See Storm Water Design Manual Chapter 4 and Appendix E for more information on determining appropriate BMPs for <b>your</b> project.</p>		
<b>Prevention of Illicit Discharges into the MS4 (SC-1)</b>		
<input type="checkbox"/> Direct irrigation water away from impervious surfaces <input type="checkbox"/> Direct vehicle wash water away from impervious surfaces <input type="checkbox"/> Other _____ <input type="checkbox"/> N/A or Infeasible (explanation) _____		
<b>Storm Drain Stenciling or Signage (SC-2)</b>		
<input type="checkbox"/> Stencil or stamp storm drains with anti-dumping message <input type="checkbox"/> Post signs prohibiting illegal dumping <input type="checkbox"/> Other _____ <input type="checkbox"/> N/A or Infeasible (explanation) _____		
<b>Protect Outdoor Materials <u>Storage Areas</u> from Rainfall, Run-On, Runoff and Wind Dispersal (SC-3)</b>		
<input type="checkbox"/> Store materials inside a covered enclosure <input type="checkbox"/> Direct runoff from downspouts and roofs away from storage areas <input type="checkbox"/> Other _____ <input type="checkbox"/> N/A or Infeasible (explanation) _____		
<b>Protect Materials Stored in Outdoor <u>Work Areas</u> from Rainfall, Run-On, Runoff and Wind Dispersal (SC-4)</b>		
<input type="checkbox"/> Locate work area away from storm drains or catch basins <input type="checkbox"/> Work over impermeable surfaces where spills and pollutants can be captured and removed <input type="checkbox"/> Other _____ <input type="checkbox"/> N/A or Infeasible (explanation) _____		
<b>Protect Trash Storage Areas from Rainfall, Run-On, Runoff and Wind Dispersal (SC-5)</b>		
<input type="checkbox"/> Locate trash containers in a roofed, walled enclosure <input type="checkbox"/> Locate trash containers away from storm drains <input type="checkbox"/> Other _____ <input type="checkbox"/> N/A or Infeasible (explanation) _____		
<b>Additional BMPs Based on Potential Sources of Runoff Pollutants (SC-6)</b>		
Other _____ Other _____ Other _____		

<b>Part 4: Construction BMPs</b>	
<b>Note that Construction BMPs are applicable to all projects per Escondido Municipal Code.</b>	
<input type="checkbox"/> Applicable construction BMPs will be installed and maintained during construction.	

What Type of Storm Water Best Management Practices (BMPs) Does my Project Need?		Storm Water and Development Projects Fact Sheet: Form I2-B
MINOR	STANDARD	PRIORITY
<ul style="list-style-type: none"> <li>• Construction BMPs</li> </ul>	<ul style="list-style-type: none"> <li>• Construction BMPs</li> <li>• Site Design BMPs</li> <li>• Source Control BMPs</li> </ul>	<ul style="list-style-type: none"> <li>• Construction BMPs</li> <li>• Site Design BMPs</li> <li>• Source Control BMPs</li> <li>• Structural BMPs</li> </ul>
<b>Minor Projects:</b>		
<p>Replacement of impervious surfaces that are part of a routine maintenance activity, such as:</p> <ul style="list-style-type: none"> <li>• Replacing roof material on an existing building</li> <li>• Restoring pavement or other surface materials affected by trenches from utility work</li> <li>• Resurfacing existing roads and parking lots, including slurry, overlay and restriping</li> <li>• Routine replacement of damaged pavement, if the sole purpose is to repair the damage</li> <li>• New or retrofit paved sidewalks, bicycle lanes, or trails that meet the following criteria:                             <ul style="list-style-type: none"> <li>(i) Designed and constructed to direct storm water runoff to adjacent vegetated areas, or other non-erodible permeable areas; OR</li> <li>(ii) Designed and constructed to be hydraulically disconnected from paved streets or roads; OR</li> <li>(iii) Designed and constructed with permeable pavements or surfaces in accordance with USEPA Green Streets guidance</li> </ul> </li> <li>• Retrofitting or redevelopment of existing paved alleys, streets or roads that are designed and constructed in accordance with the USEPA Green Streets guidance</li> <li>• Restoring a historic building to its original historic design</li> </ul> <p>Repair or improvements to an existing building or structure that do not alter the size:</p> <ul style="list-style-type: none"> <li>• Plumbing, electrical and HVAC work</li> <li>• Interior alterations including major interior remodels and tenant build-out within an existing commercial building</li> <li>• Exterior alterations that do not change the general dimensions and structural framing of the building (does not include building additions or projects where the existing building is demolished)</li> </ul> <p><b>Note:</b> Except as otherwise noted in the Escondido Storm Water Design Manual, Section 1.3.1, work that creates impervious surface outside of the existing impervious footprint is not considered routine maintenance.</p> <p>Additional categories include:</p> <ul style="list-style-type: none"> <li>• Landscaping, including rock or gravel beds</li> <li>• Retaining walls or curbs placed to support landscaping or sidewalks</li> <li>• Fencing and screen walls</li> <li>• Temporary or portable items such as containers and sheds</li> <li>• Replacement of sidewalks</li> <li>• Covers, such as a patio cover or trellis, over existing impervious surface</li> </ul>		
<b>Other Types of Work:</b>	<ul style="list-style-type: none"> <li>• If your permitted project is any other type of work, it is either a <b>Standard</b> or a <b>Priority</b> Project.</li> <li>• See the <b>Standard</b> or <b>Priority</b> project submittal checklists for more information</li> </ul>	

## Appendix I: Forms and Checklists

Form I-2A: Site Information Checklist for PDPs is available as part of the PDP SWQMP available via the City's website: <https://www.escondido.org/bmps-for-new-development-redevelopment.aspx>

Source Control BMP Checklist for All Development Projects (Standard Projects and PDPs)		Form I-2b	
<b>Project Identification</b>			
Project Name			
Permit Application Number			
<b>Source Control BMPs</b>			
All development projects must implement source control BMPs SC-1 through SC-6 where applicable and feasible. See Chapter 4 and Appendix E of the manual for information to implement source control BMPs shown in this checklist.			
Answer each category below pursuant to the following.			
<ul style="list-style-type: none"> <li>• "Yes" means the project will implement the source control BMP as described in Chapter 4 and/or Appendix E of the manual. Discussion / justification is not required.</li> <li>• "No" means the BMP is applicable to the project but it is not feasible to implement. Discussion / justification must be provided.</li> <li>• "N/A" means the BMP is not applicable at the project site because the project does not include the feature that is addressed by the BMP (e.g., the project has no outdoor materials storage areas). Discussion / justification may be provided.</li> </ul>			
<b>Source Control Requirement</b>		<b>Applied?</b>	
<b>4.2.1</b> Prevention of Illicit Discharges into the MS4		<input type="checkbox"/> Yes	<input type="checkbox"/> No
		<input type="checkbox"/> N/A	
Discussion / justification if SC-1 not implemented:			
<b>4.2.2</b> Storm Drain Stenciling or Signage		<input type="checkbox"/> Yes	<input type="checkbox"/> No
		<input type="checkbox"/> N/A	
Discussion / justification if SC-2 not implemented:			
<b>4.2.3</b> Protect Outdoor Materials Storage Areas from Rainfall, Run-On, Runoff, and Wind Dispersal		<input type="checkbox"/> Yes	<input type="checkbox"/> No
		<input type="checkbox"/> N/A	
Discussion / justification if SC-3 not implemented:			
<b>4.2.4</b> Protect Materials Stored in Outdoor Work Areas from Rainfall, Run-On, Runoff, and Wind Dispersal		<input type="checkbox"/> Yes	<input type="checkbox"/> No
		<input type="checkbox"/> N/A	
Discussion / justification if SC-4 not implemented:			

Form I-4 Page 2 of 2			
Source Control Requirement	Applied?		
<b>4.2.5</b> Protect Trash Storage Areas from Rainfall, Run-On, Runoff, and Wind Dispersal	<input type="checkbox"/> Yes	<input type="checkbox"/> No	<input type="checkbox"/> N/A
Discussion / justification if SC-5 not implemented:			
<b>4.2.6</b> Additional BMPs Based on Potential Sources of Runoff Pollutants (must answer for each source listed below)			
<input type="checkbox"/> Onsite storm drain inlets	<input type="checkbox"/> Yes	<input type="checkbox"/> No	<input type="checkbox"/> N/A
<input type="checkbox"/> Interior floor drains and elevator shaft sump pumps	<input type="checkbox"/> Yes	<input type="checkbox"/> No	<input type="checkbox"/> N/A
<input type="checkbox"/> Interior parking garages	<input type="checkbox"/> Yes	<input type="checkbox"/> No	<input type="checkbox"/> N/A
<input type="checkbox"/> Need for future indoor & structural pest control	<input type="checkbox"/> Yes	<input type="checkbox"/> No	<input type="checkbox"/> N/A
<input type="checkbox"/> Landscape/outdoor pesticide use	<input type="checkbox"/> Yes	<input type="checkbox"/> No	<input type="checkbox"/> N/A
<input type="checkbox"/> Pools, spas, ponds, decorative fountains, and other water features	<input type="checkbox"/> Yes	<input type="checkbox"/> No	<input type="checkbox"/> N/A
<input type="checkbox"/> Food service	<input type="checkbox"/> Yes	<input type="checkbox"/> No	<input type="checkbox"/> N/A
<input type="checkbox"/> Refuse areas	<input type="checkbox"/> Yes	<input type="checkbox"/> No	<input type="checkbox"/> N/A
<input type="checkbox"/> Industrial processes	<input type="checkbox"/> Yes	<input type="checkbox"/> No	<input type="checkbox"/> N/A
<input type="checkbox"/> Outdoor storage of equipment or materials	<input type="checkbox"/> Yes	<input type="checkbox"/> No	<input type="checkbox"/> N/A
<input type="checkbox"/> Vehicle and equipment cleaning	<input type="checkbox"/> Yes	<input type="checkbox"/> No	<input type="checkbox"/> N/A
<input type="checkbox"/> Vehicle/equipment repair and maintenance	<input type="checkbox"/> Yes	<input type="checkbox"/> No	<input type="checkbox"/> N/A
<input type="checkbox"/> Fuel dispensing areas	<input type="checkbox"/> Yes	<input type="checkbox"/> No	<input type="checkbox"/> N/A
<input type="checkbox"/> Loading docks	<input type="checkbox"/> Yes	<input type="checkbox"/> No	<input type="checkbox"/> N/A
<input type="checkbox"/> Fire sprinkler test water	<input type="checkbox"/> Yes	<input type="checkbox"/> No	<input type="checkbox"/> N/A
<input type="checkbox"/> Miscellaneous drain or wash water	<input type="checkbox"/> Yes	<input type="checkbox"/> No	<input type="checkbox"/> N/A
<input type="checkbox"/> Plazas, sidewalks, and parking lots	<input type="checkbox"/> Yes	<input type="checkbox"/> No	<input type="checkbox"/> N/A
Discussion / justification if SC-6 not implemented. Clearly identify which sources of runoff pollutants are discussed. Justification must be provided for <u>all</u> "No" answers shown above.			



Site Design BMP Checklist for All Development Projects (Standard Projects and PDPs)		Form I-2c	
<b>Project Identification</b>			
Project Name			
Permit Application Number			
<b>Site Design BMPs</b>			
All development projects must implement site design BMPs SD-1 through SD-8 where applicable and feasible. See Chapter 4 and Appendix E of the manual for information to implement site design BMPs shown in this checklist.			
Answer each category below pursuant to the following.			
<ul style="list-style-type: none"> <li>• "Yes" means the project will implement the site design BMP as described in Chapter 4 and/or Appendix E of the manual. Discussion / justification is not required.</li> <li>• "No" means the BMP is applicable to the project but it is not feasible to implement. Discussion / justification must be provided.</li> <li>• "N/A" means the BMP is not applicable at the project site because the project does not include the feature that is addressed by the BMP (e.g., the project site has no existing natural areas to conserve). Discussion / justification may be provided.</li> </ul>			
<b>Site Design Requirement</b>		<b>Applied?</b>	
<b>4.3.1</b> Maintain Natural Drainage Pathways and Hydrologic Features		<input type="checkbox"/> Yes	<input type="checkbox"/> No <input type="checkbox"/> N/A
Discussion / justification if 4.3.1 not implemented:			
1-1 Are existing natural drainage pathways and hydrologic features mapped on the site map?	<input type="checkbox"/> Yes	<input type="checkbox"/> No	<input type="checkbox"/> N/A
1-2 Are trees implemented? If yes, are they shown on the site map?	<input type="checkbox"/> Yes	<input type="checkbox"/> No	<input type="checkbox"/> N/A
1-3 Implemented trees meet the design criteria in 4.3.1 Fact Sheet (e.g. soil volume, maximum credit, etc.)?	<input type="checkbox"/> Yes	<input type="checkbox"/> No	<input type="checkbox"/> N/A
1-4 Is tree credit volume calculated using Appendix B.2.2.1 and SD-1 Fact Sheet in Appendix E?	<input type="checkbox"/> Yes	<input type="checkbox"/> No	<input type="checkbox"/> N/A
<b>4.3.2</b> Conserve Natural Areas, Soils, and Vegetation		<input type="checkbox"/> Yes	<input type="checkbox"/> No <input type="checkbox"/> N/A
Discussion / justification if 4.3.2 not implemented:			
<b>4.3.3</b> Minimize Impervious Area		<input type="checkbox"/> Yes	<input type="checkbox"/> No <input type="checkbox"/> N/A
Discussion / justification if 4.3.3 not implemented:			

Form I-2c Page 2 of 3			
Site Design Requirement	Applied?		
<b>4.3.4 Minimize Soil Compaction</b>	<input type="checkbox"/> Yes	<input type="checkbox"/> No	<input type="checkbox"/> N/A
Discussion / justification if 4.3.4 not implemented:			
<b>4.3.5 Impervious Area Dispersion</b>	<input type="checkbox"/> Yes	<input type="checkbox"/> No	<input type="checkbox"/> N/A
Discussion / justification if 4.3.5 not implemented:			
5-1 Is the pervious area receiving runoff from impervious area identified on the site map?	<input type="checkbox"/> Yes	<input type="checkbox"/> No	<input type="checkbox"/> N/A
5-2 Does the pervious area satisfy the design criteria in 4.3.5. Fact Sheet in Appendix E (e.g. maximum slope, minimum length, etc.)	<input type="checkbox"/> Yes	<input type="checkbox"/> No	<input type="checkbox"/> N/A
5-3 Is impervious area dispersion credit volume calculated using Appendix B.2.1.1 and 4.3.5 Fact Sheet in Appendix E?	<input type="checkbox"/> Yes	<input type="checkbox"/> No	<input type="checkbox"/> N/A
<b>4.3.6 Runoff Collection</b>	<input type="checkbox"/> Yes	<input type="checkbox"/> No	<input type="checkbox"/> N/A
Discussion / justification if 4.3.6 not implemented:			
6a-1 Are green roofs implemented in accordance with design criteria in 4.3.6A Fact Sheet? If yes, are they shown on the site map?	<input type="checkbox"/> Yes	<input type="checkbox"/> No	<input type="checkbox"/> N/A
6a-2 Is the green roof credit volume calculated using Appendix B.2.1.2 and 4.3.6A Fact Sheet in Appendix E?	<input type="checkbox"/> Yes	<input type="checkbox"/> No	<input type="checkbox"/> N/A
6b-1 Are permeable pavements implemented in accordance with design criteria in 4.3.6B Fact Sheet? If yes, are they shown on the site map?	<input type="checkbox"/> Yes	<input type="checkbox"/> No	<input type="checkbox"/> N/A
6b-2 Is the permeable pavement credit volume calculated using Appendix B.2.1.3 and 4.3.6B Fact Sheet in Appendix E?	<input type="checkbox"/> Yes	<input type="checkbox"/> No	<input type="checkbox"/> N/A
<b>4.3.7 Landscaping with Native or Drought Tolerant Species</b>	<input type="checkbox"/> Yes	<input type="checkbox"/> No	<input type="checkbox"/> N/A
Discussion / justification if 4.3.7 not implemented:			

Form I-2c Page 3 of 3			
Site Design Requirement	Applied?		
4.3.8 Harvesting and Using Precipitation	<input type="checkbox"/> Yes	<input type="checkbox"/> No	<input type="checkbox"/> N/A
Discussion / justification if 4.3.8 not implemented:			
8-1 Are rain barrels implemented in accordance with design criteria in 4.3.8 Fact Sheet? If yes, are they shown on the site map?	<input type="checkbox"/> Yes	<input type="checkbox"/> No	<input type="checkbox"/> N/A
8-2 Is the rain barrel credit volume calculated using Appendix B.2.2.2 and 4.3.8 Fact Sheet in Appendix E?	<input type="checkbox"/> Yes	<input type="checkbox"/> No	<input type="checkbox"/> N/A



Form I-3 Page 2 of 3

(Page reserved for continuation of description of general strategy for structural BMP implementation at the site)

(Continued from page 1)

Form I-3 Page 3 of X (Copy as many as needed)	
Structural BMP Summary Information	
(Copy this page as needed to provide information for each individual proposed structural BMP)	
Structural BMP ID No.	
Construction Plan Sheet No.	
Type of structural BMP: <input type="checkbox"/> Retention by harvest and use (HU-1) <input type="checkbox"/> Retention by infiltration basin (INF-1) <input type="checkbox"/> Retention by bioretention (INF-2) <input type="checkbox"/> Retention by permeable pavement (INF-3) <input type="checkbox"/> Retention by dry wells (INF-4) <input type="checkbox"/> Partial retention by biofiltration with partial retention (PR-1) <input type="checkbox"/> Biofiltration (BF-1) <input type="checkbox"/> Biofiltration with Nutrient Sensitive Media Design (BF-2) <input type="checkbox"/> Proprietary Biofiltration (BF-3) meeting all requirements of Appendix F <input type="checkbox"/> Flow-thru treatment control with prior lawful approval to meet earlier PDP requirements (provide BMP type/description in discussion section below) <input type="checkbox"/> Flow-thru treatment control included as pre-treatment/forebay for an onsite retention or biofiltration BMP (provide BMP type/description and indicate which onsite retention or biofiltration BMP it serves in discussion section below) <input type="checkbox"/> Flow-thru treatment control with alternative compliance (provide BMP type/description in discussion section below) <input type="checkbox"/> Detention pond or vault for hydromodification management <input type="checkbox"/> Other (describe in discussion section below)	
Purpose: <input type="checkbox"/> Pollutant control only <input type="checkbox"/> Hydromodification control only <input type="checkbox"/> Combined pollutant control and hydromodification control <input type="checkbox"/> Pre-treatment/forebay for another structural BMP <input type="checkbox"/> Other (describe in discussion section below)	
Who will certify construction of this BMP? Provide name and contact information for the party responsible to sign BMP verification forms (See Section 8.2.3.2 of the Storm Water Design Manual)	
Who will be the final owner of this BMP?	<input type="checkbox"/> HOA <input type="checkbox"/> Property Owner <input type="checkbox"/> City <input type="checkbox"/> Other (describe)
Who will maintain this BMP into perpetuity?	<input type="checkbox"/> HOA <input type="checkbox"/> Property Owner <input type="checkbox"/> City <input type="checkbox"/> Other (describe)
What is the funding mechanism for maintenance?	
Discussion (as needed):	

Harvest and Use Feasibility Checklist		Form I-7
<p>1. Is there a demand for harvested water (check all that apply) at the project site that is reliably present during the wet season?</p> <p><input type="checkbox"/> Toilet and urinal flushing</p> <p><input type="checkbox"/> Landscape irrigation</p> <p><input type="checkbox"/> Other: _____</p>		
<p>2. If there is a demand; estimate the anticipated average wet season demand over a period of 36 hours. Guidance for planning level demand calculations for toilet/urinal flushing and landscape irrigation is provided in Section B.3.2.</p> <p>[Provide a summary of calculations here]</p>		
<p>3. Calculate the DCV using worksheet B-2.1.</p> <p>DCV = _____ (cubic feet)</p>		
<p>3a. Is the 36 hour demand greater than or equal to the DCV? </p> <p><input type="checkbox"/> Yes / <input type="checkbox"/> No </p> <p style="text-align: center;"></p>	<p>3b. Is the 36 hour demand greater than 0.25DCV but less than the full DCV? </p> <p><input type="checkbox"/> Yes / <input type="checkbox"/> No </p> <p style="text-align: center;"></p>	<p>3c. Is the 36 hour demand less than 0.25DCV?</p> <p><input type="checkbox"/> Yes </p>
<p>Harvest and use appears to be feasible. Conduct more detailed evaluation and sizing calculations to confirm that DCV can be used at an adequate rate to meet drawdown criteria.</p>	<p>Harvest and use may be feasible. Conduct more detailed evaluation and sizing calculations to determine feasibility. Harvest and use may only be able to be used for a portion of the site, or (optionally) the storage may need to be upsized to meet long term capture targets while draining in longer than 36 hours.</p>	<p>Harvest and use is considered to be infeasible.</p>
<p>Is harvest and use feasible based on further evaluation?</p> <p><input type="checkbox"/> Yes, refer to Appendix E to select and size harvest and use BMPs.</p> <p><input type="checkbox"/> No, select alternate BMPs.</p>		

Note: 36-hour demand calculations are for feasibility analysis only. Once feasibility analysis is complete the applicant may be allowed to use a different drawdown time provided they meet the 80% annual capture standard (refer to B.4.2) and 96-hour vector control drawdown requirement.

## Appendix I: Forms and Checklists

Refer to Appendix C, Worksheet C.4-1 and C.4-2, or the PDP SWQMP Template available at <https://www.escondido.org/bmps-for-new-development-redevelopment.aspx> for Form I-8.



Factor of Safety and Design Infiltration Rate Worksheet			Form I-9		
Factor Category		Factor Description	Assigned Weight (w)	Factor Value (v)	Product (p) $p = w \times v$
A	Suitability Assessment	Soil assessment methods	0.25		
		Predominant soil texture	0.25		
		Site soil variability	0.25		
		Depth to groundwater / impervious layer	0.25		
		Suitability Assessment Safety Factor, $S_A = \sum p$			
B	Design	Level of pretreatment/ expected sediment loads	0.5		
		Redundancy/resiliency	0.25		
		Compaction during construction	0.25		
		Design Safety Factor, $S_B = \sum p$			
Combined Safety Factor, $S_{total} = S_A \times S_B$					
Observed Infiltration Rate, inch/hr, $K_{observed}$ (corrected for test-specific bias)					
Design Infiltration Rate, in/hr, $K_{design} = K_{observed} / S_{total}$					
Supporting Data					
Briefly describe infiltration test and provide reference to test forms:					

Compact (high rate) Biofiltration BMP Checklist		Form I-10
<p>Compact (high rate) biofiltration BMPs have a media filtration rate greater than 5 in/hr. and a media surface area smaller than 3% of contributing area times adjusted runoff factor. Compact biofiltration BMPs are typically proprietary BMPs that may qualify as biofiltration.</p> <p>A compact biofiltration BMP may satisfy the pollutant control requirements for a DMA onsite in some cases. This depends on the characteristics of the DMA and the performance certification/data of the BMP. If the pollutant control requirements for a DMA are met onsite, then the DMA is not required to participate in an offsite storm water alternative compliance program to meet its pollutant control obligations.</p> <p>An applicant using a compact biofiltration BMP to meet the pollutant control requirements onsite must complete Section 1 of this form and include it in the PDP SWQMP. A separate form must be completed for each DMA. In instances where the City Engineer does not agree with the applicant’s determination, Section 2 of this form will be completed by the City and returned to the applicant.</p>		
<p><b>Section 1: Biofiltration Criteria Checklist (Appendix F)</b></p> <p>Refer to Part 1 of the Storm Water Standards to complete this section. When separate forms/worksheets are referenced below, the applicant must also complete these separate forms/worksheets (as applicable) and include in the PDP SWQMP. The criteria numbers below correspond to the criteria numbers in Appendix F.</p>		
Criteria	Answer	Progression
<p><b>Criteria 1 and 3:</b></p> <p>What is the infiltration condition of the DMA?</p> <p>Refer to Section 5.4.2 and Appendix C of the BMP Design Manual (Part 1 of Storm Water Standards) for guidance.</p> <p>Applicant must complete and include the following in the PDP SWQMP submittal to support the feasibility determination:</p> <ul style="list-style-type: none"> <li>Infiltration Feasibility Condition Letter; or</li> <li>Worksheet C.4-1: Form I-8A and Worksheet C.4-2: Form I- 8B.</li> </ul> <p>Applicant must complete and include all applicable sizing worksheets in the SWQMP submittal</p>	<input type="checkbox"/> Full Infiltration Condition	<p><b>Stop.</b> Compact biofiltration BMP is not allowed.</p>
	<input type="checkbox"/> Partial Infiltration Condition	<p>Compact biofiltration BMP is only allowed, if the target volume retention is met onsite (Refer to Table B.5-1 in Appendix B.5). Use Worksheet B.5- 2 in Appendix B.5 to estimate the target volume retention (Note: retention in this context means reduction).</p> <p>If the required volume reduction is achieved <b>proceed to Criteria 2.</b></p> <p>If the required volume reduction is not achieved, compact biofiltration BMP is not allowed. <b>Stop.</b></p>
	<input type="checkbox"/> No Infiltration Condition	<p>Compact biofiltration BMP is allowed if volume retention criteria in Table B.5-1 in Appendix B.5 for the no infiltration condition is met. Compliance with this criterion must be documented in the PDP SWQMP.</p> <p>If the criteria in Table B.5-1 is met <b>proceed to Criteria 2.</b></p> <p>If the criteria in Table B.5-1 is not met, compact biofiltration BMP is not allowed. <b>Stop.</b></p>

Compact (high rate) Biofiltration BMP Checklist		Form I-10
<b>Provide basis for Criteria 1 and 3:</b>		
<b>Feasibility Analysis:</b>		
Summarize findings and include either infiltration feasibility condition letter or Worksheet C.4-1: Form I-8A and Worksheet C.4-2: Form I-8B in the PDP SWQMP submittal.		
<b>If Partial Infiltration Condition:</b>		
Provide documentation that target volume retention is met (include Worksheet B.5-2 in the PDP SWQMP submittal). Worksheet B.5-7 in Appendix B.5 can be used to estimate volume retention benefits from landscape areas.		
<b>If No Infiltration Condition:</b>		
Provide documentation that the volume retention performance standard is met (include Worksheet B.5-2 in the PDP SWQMP submittal) in the PDP SWQMP submittal. Worksheet B.5-6 in Appendix B.5 can be used to document that the performance standard is met.		
Criteria	Answer	Progression
<b>Criteria 2:</b> Is the compact biofiltration BMP sized to meet the performance standard from the MS4 Permit?  Refer to Appendix B.5 and Appendix F.2 of the BMP Design Manual (Part 1 of Storm Water Standards) for guidance.	<input type="checkbox"/> Meets Flow Based Criteria	Use guidance from <b>Appendix F.2.2</b> to size the compact biofiltration BMP to meet the flow based criteria. Include the calculations in the PDP SWQMP.  Use parameters for sizing consistent with manufacturer guidelines and conditions of its third party certifications (i.e. a BMP certified at a loading rate of 1 gpm/sq. ft. cannot be designed using a loading rate of 1.5 gpm/sq. ft.)  <b>Proceed to Criteria 4.</b>
	<input type="checkbox"/> Meets Volume Based Criteria	Provide documentation that the compact biofiltration BMP has a total static (i.e. non-routed) storage volume, including pore-spaces and pre-filter detention volume (Refer to Appendix B.5 for a schematic) of at least 0.75 times the portion of the DCV not reliably retained onsite.  <b>Proceed to Criteria 4.</b>
	<input type="checkbox"/> Does not Meet either	<b>Stop.</b> Compact biofiltration BMP is not allowed.

Compact (high rate) Biofiltration BMP Checklist		Form I-10
<p><b>Provide basis for Criteria 2:</b> Provide documentation that the BMP meets the numeric criteria and is designed consistent with the manufacturer guidelines and conditions of its third-party certification (i.e., loading rate, etc., as applicable).</p>		
<p> </p>		
Criteria	Answer	Progression
<p><b>Criteria 4:</b></p> <p>Does the compact biofiltration BMP meet the pollutant treatment performance standard for the projects most significant pollutants of concern?</p> <p>Refer to Appendix B.6 and Appendix F.1 of the BMP Design Manual (Part 1 of Storm Water Standards) for guidance.</p>	<input type="checkbox"/> Yes, meets the TAPE certification.	<p>Provide documentation that the compact BMP has an appropriate TAPE certification for the projects most significant pollutants of concern. <b>Proceed to Criteria 5.</b></p>
	<input type="checkbox"/> Yes, through other third-party documentation.	<p>Acceptance of third-party documentation is at the discretion of the City Engineer. The City engineer will consider, (a) the data submitted; (b) representativeness of the data submitted; and (c) consistency of the BMP performance claims with pollutant control objectives in Table F.1-2 and Table F.1-1 while making this determination. If a compact biofiltration BMP is not accepted, a written explanation/ reason will be provided in Section 2. <b>Proceed to Criteria 5.</b></p>
	<input type="checkbox"/> No	<p><b>Stop.</b> Compact biofiltration BMP is not allowed.</p>
<p><b>Provide basis for Criteria 4:</b> Provide documentation that identifies the projects most significant pollutants of concern and TAPE certification or other third party documentation that shows that the compact biofiltration BMP meets the pollutant treatment performance standard for the projects most significant pollutants of concern.</p>		
<p> </p>		

Appendix I: Forms and Checklists

Compact (high rate) Biofiltration BMP Checklist		Form I-10
Criteria	Answer	Progression
<b>Criteria 5:</b> Is the compact biofiltration BMP designed to promote appropriate biological activity to support and maintain treatment process? Refer to Appendix F of the BMP Design Manual (Part 1 of Storm Water Standards) for guidance.	<input type="checkbox"/> Yes	Provide documentation that the compact biofiltration BMP support appropriate biological activity. Refer to Appendix F for guidance. <b>Proceed to Criteria 6.</b>
	<input type="checkbox"/> No	<b>Stop.</b> Compact biofiltration BMP is not allowed.
<b>Provide basis for Criteria 5:</b>  Provide documentation that appropriate biological activity is supported by the compact biofiltration BMP to maintain treatment process.		
Criteria	Answer	Progression
<b>Criteria 6:</b> Is the compact biofiltration BMP designed with a hydraulic loading rate to prevent erosion, scour and channeling within the BMP?	<input type="checkbox"/> Yes	Provide documentation that the compact biofiltration BMP is used in a manner consistent with manufacturer guidelines and conditions of its third-party certification. <b>Proceed to Criteria 7.</b>
	<input type="checkbox"/> No	<b>Stop.</b> Compact biofiltration BMP is not allowed.
<b>Provide basis for Criteria 6:</b>  Provide documentation that the BMP meets the numeric criteria and is designed consistent with the manufacturer guidelines and conditions of its third-party certification (i.e., maximum tributary area, maximum inflow velocities, etc., as applicable).		

Appendix I: Forms and Checklists

Compact (high rate) Biofiltration BMP Checklist		Form I-10
Criteria	Answer	Progression
<p><b>Criteria 7:</b> Is the compact biofiltration BMP maintenance plan consistent with manufacturer guidelines and conditions of its third-party certification (i.e., maintenance activities, frequencies)?</p>	<input type="checkbox"/> Yes, and the compact BMP is privately owned, operated and not in the public right of way.	<p>Submit a maintenance agreement that will also include a statement that the BMP will be maintained in accordance with manufacturer guidelines and conditions of third-party certification. <b>Stop.</b> The compact biofiltration BMP meets the required criteria.</p>
	<input type="checkbox"/> Yes, and the BMP is either owned or operated by the City or in the public right of way.	<p>Approval is at the discretion of the City Engineer. The city engineer will consider maintenance requirements, cost of maintenance activities, relevant previous local experience with operation and maintenance of the BMP type, ability to continue to operate the system in event that the vending company is no longer operating as a business or other relevant factors while making the determination. <b>Stop.</b> Consult the City Engineer for a determination.</p>
	<input type="checkbox"/> No	<p><b>Stop.</b> Compact biofiltration BMP is not allowed.</p>
<p><b>Provide basis for Criteria 7:</b></p> <p>Include copy of manufacturer guidelines and conditions of third-party certification in the maintenance agreement. PDP SWQMP must include a statement that the compact BMP will be maintained in accordance with manufacturer guidelines and conditions of third-party certification.</p>		

<b>Compact (high rate) Biofiltration BMP Checklist</b>		<b>Form I-10</b>
<b>Section 1: Biofiltration Criteria Checklist (Appendix F)</b>		
Is the proposed compact BMP accepted by the City Engineer for onsite pollutant control compliance for the DMA?	<input type="checkbox"/> Yes <input type="checkbox"/> No, See explanation below	
Explanation/reason if the compact BMP is not accepted by the City for onsite pollutant control compliance:		

**Appendix I: Forms and Checklists**

Downstream Systems Requirements for Preservation of Coarse Sediment Supply		Form I-11	
When it has been determined that potential critical coarse sediment yield areas exist within the project site, the next step is to determine whether downstream systems would be sensitive to reduction of coarse sediment yield from the project site. Use this form to document the evaluation of downstream systems requirements for preservation of coarse sediment supply.			
Project Name:			
Project Tracking Number / Permit Application Number:			
1	Will the project discharge runoff to a hardened MS4 system (pipe or lined channel) or an un-lined channel?	<input type="checkbox"/> Hardened MS4 system	Go to 2
		<input type="checkbox"/> Un-lined channel	Go to 4
2	Will the hardened MS4 system convey sediment (e.g., a concrete-lined channel with steep slope and cleansing velocity) or sink sediment (e.g., flat slopes, constrictions, treatment BMPs, or ponds with restricted outlets within the system will trap sediment and not allow conveyance of coarse sediment from the project site to an un-lined system).	<input type="checkbox"/> Convey	Go to 3
		<input type="checkbox"/> Sink	Go to 7
3	What kind of receiving water will the hardened MS4 system convey the sediment to?	<input type="checkbox"/> Un-lined channel	Go to 4
		<input type="checkbox"/> Lake	Go to 7
		<input type="checkbox"/> Reservoir <input type="checkbox"/> Bay	
		<input type="checkbox"/> Lagoon <input type="checkbox"/> Ocean	Go to 6
4	Is the un-lined channel impacted by deposition of sediment? This condition must be documented by the local agency.	<input type="checkbox"/> Yes	Go to 7
		<input type="checkbox"/> No	Go to 5
5	End – Preserve coarse sediment supply to protect un-lined channels from accelerated erosion due to reduction of coarse sediment yield from the project site unless further investigation determines the sediment is not critical to the receiving stream. Sediment that is critical to receiving streams is the sediment that is a significant source of bed material to the receiving stream (bed sediment supply) (see Section 6.2.3 and Appendix H.2 of the manual).		
6	End – Provide management measures for preservation of coarse sediment supply (protect beach sand supply).		
7	End – Downstream system does not warrant preservation of coarse sediment supply, no measures for protection of critical coarse sediment yield areas onsite are necessary. Use the space below to describe the basis for this finding for the project.		



# Glossary of Key Terms

<b>50% Rule</b>	Refers to an MS4 Permit standard for redevelopment PDPs (PDPs on previously developed sites) that defines whether the redevelopment PDP must meet storm water management requirements for the entire development or only for the newly created or replaced impervious surface. Refer to Section 1.7.
<b>Aggregate</b>	Hard, durable material of mineral origin typically consisting of gravel, crushed stone, crushed quarry or mine rock. Gradation varies depending on application within a BMP as bedding, filter course, or storage.
<b>Aggregate Storage Layer</b>	Layer within a BMP that serves to provide a conduit for conveyance, detention storage, infiltration storage, saturated storage, or a combination thereof.
<b>Alternative Compliance Programs</b>	A program that allows PDPs to participate in an offsite mitigation project in lieu of implementing the onsite structural BMP performance requirements required under the MS4 Permit. Refer to Section 1.8 for more information on alternative compliance programs.
<b>Bed Sediment</b>	The part of the sediment load in channel flow that moves along the bed by sliding or saltation, and part of the suspended sediment load, that principally constitutes the channel bed.
<b>Bedding</b>	Aggregate used to establish a foundation for structures such as pipes, manholes, and pavement.
<b>Biodegradation</b>	Decomposition of pollutants by biological means.

**Biofiltration BMPs**

Biofiltration BMPs are shallow basins filled with treatment media and drainage rock that treat storm water runoff by capturing and detaining inflows prior to controlled release through minimal incidental infiltration, evapotranspiration, or discharge via underdrain or surface outlet structure. Treatment is achieved through filtration, sedimentation, sorption, biochemical processes and/or vegetative uptake. These BMPs must be sized to:[a] Treat 1.5 times the DCV not reliably retained onsite, OR[b] Treat the DCV not reliably retained onsite with a flow-thru design that has a total volume, including pore spaces and pre-filter detention volume, sized to hold at least 0.75 times the portion of the DCV not reliably retained onsite. (See Section 5.5.3 and Appendix B.5 for illustration and additional information).

**Biofiltration Treatment**

Treatment from a BMP meeting the biofiltration standard.

**Biofiltration with  
Partial Retention BMPs**

Biofiltration with partial retention BMPs are shallow basins filled with treatment media and drainage rock that manage storm water runoff through infiltration, evapotranspiration, and biofiltration. Partial retention is characterized by a subsurface stone infiltration storage zone in the bottom of the BMP below the elevation of the discharge from the underdrains. The discharge of biofiltered water from the underdrain occurs when the water level in the infiltration storage zone exceeds the elevation of the underdrain outlet. (See Section 5.5.2.1 for illustration and additional information).

**Bioretention BMPs**

Vegetated surface water systems that filter water through vegetation and soil, or engineered media prior to infiltrating into native soils. Bioretention BMPs in this manual retain the entire DCV prior to overflow to the downstream conveyance system. (See Section 5.5.1.2 for illustration and additional information).

**BMP**

A procedure or device designed to minimize the quantity of runoff pollutants and / or volumes that flow to downstream receiving water bodies. Refer to Section 2.2.2.1.

**BMP Sizing Calculator**

An on-line tool that was developed under the 2007 MS4 Permit to facilitate the sizing factor method for designing flow control BMPs for hydromodification management. The BMP Sizing Calculator has been discontinued as of June 30, 2014.

<b>Cistern</b>	A vessel for storing water. In this manual, a cistern is typically a rain barrel, tank, vault, or other artificial reservoir.
<b>Coarse Sediment Yield Area</b>	A GLU with coarse-grained geologic material (material that is expected to produce greater than 50% sand when weathered). See the following terms modifying coarse sediment yield area: critical, potential critical.
<b>Compact Biofiltration BMP</b>	A biofiltration BMP, either proprietary or non-proprietary in origin, that is designed to provide storm water pollutant control within a smaller footprint than a typical biofiltration BMP, usually through use of specialized media that is able to efficiently treat high storm water inflow rates.
<b>Conditions of Approval</b>	Requirements a jurisdiction may adopt for a project in connection with a discretionary action (e.g., issuance of a use permit). COAs may include features to be incorporated into the final plans for the project and may also specify uses, activities, and operational measures that must be observed over the life of the project.
<b>Contemporary Design Standards</b>	This term refers to design standards that are reasonably consistent with the current state of practice and are based on desired outcomes that are reasonably consistent with the context of the MS4 Permit and Model BMP Design Manual. For example, a detention basin that is designed solely to mitigate peak flow rates would not be considered a contemporary water quality BMP design because it is not consistent with the goal of water quality improvement. Current state of the practice recognizes that a drawdown time of 24 to 72 hour is typically needed to promote settling. For practical purposes, design standards can be considered “contemporary” if they have been published within the last 10 years, preferably in California or Washington State, and are specifically intended for storm water quality management.
<b>Continuous Simulation Modeling</b>	A method of hydrological analysis in which a set of rainfall data (typically hourly for 30 years or more) is used as input, and a continuous runoff hydrograph is calculated over the same time period. Continuous simulation models typically track dynamic soil and storage conditions during and between storm events. The output is then analyzed statistically for the purposes of comparing runoff patterns under different conditions (for example, pre- and post-development-project).

<b>Copermittees</b>	See Jurisdiction.
<b>Critical Channel Flow (Qc)</b>	The channel flow that produces the critical shear stress that initiates bed movement or that erodes the toe of channel banks. When measuring Qc, it should be based on the weakest boundary material – either bed or bank.
<b>Critical Coarse Sediment Yield Areas</b>	A GLU with coarse-grained geologic material and high relative sediment production, where the sediment produced is critical to the receiving stream (a source of bed material to the receiving stream). See also: potential critical coarse sediment yield area.
<b>Critical Shear Stress</b>	The shear stress that initiates channel bed movement or that erodes the toe of channel banks. See also critical channel flow.
<b>DCV</b>	A volume of storm water runoff produced from the 85th percentile, 24-hour storm event. See Section 2.2.2.2.
<b>De Minimis DMA</b>	De minimis DMAs are very small areas that are not considered to be significant contributors of pollutants, and are considered not practicable to drain to a BMP. See Section 5.2.2.
<b>Depth</b>	The distance from the top, or surface, to the bottom of a BMP component.
<b>Detention</b>	Temporarily holding back storm water runoff via a designed outlet (e.g., underdrain, orifice) to provide flow rate and duration control.
<b>Detention Storage</b>	Storage that provides detention as the outflow mechanism.
<b>Development Footprint</b>	The limits of all grading and ground disturbance, including landscaping, associated with a project.
<b>Development Project</b>	Construction, rehabilitation, redevelopment, or reconstruction of any public or private projects. Includes both new development and redevelopment. Also includes whole of the action as defined by CEQA. See Section 1.3.

<b>Direct Discharge</b>	The connection of project site runoff to an exempt receiving water body, which could include an exempt river reach, reservoir or lagoon. To qualify as a direct discharge, the discharge elevation from the project site outfall must be at or below either the normal operating water surface elevation or the reservoir spillway elevation, and properly designed energy dissipation must be provided. “Direct discharge” may be more specifically defined by each municipality.
<b>Direct Infiltration</b>	Infiltration via methods or devices, such as dry wells or infiltration trenches, designed to bypass the mantle of surface soils that is unsaturated and more organically active and transmit runoff directly to deeper subsurface soils.
<b>DMAs</b>	See <b>Section 3.3.3.</b>
<b>Drawdown Time</b>	The time required for a storm water detention or infiltration facility to drain and return to the dry-weather condition. For detention facilities, drawdown time is a function of basin volume and outlet orifice size. For infiltration facilities, drawdown time is a function of basin volume and infiltration rate.
<b>Enclosed Embayments (Enclosed Bays)</b>	Enclosed bays are indentations along the coast that enclose an area of oceanic water within distinct headlands or harbor works. Enclosed bays include all bays where the narrowest distance between the headlands or outermost bay works is less than 75 percent of the greatest dimension of the enclosed portion of the bay. Enclosed bays do not include inland surface waters or ocean waters. In San Diego: Mission Bay and San Diego Bay.
<b>Environmentally Sensitive Areas (ESAs)</b>	Areas that include but are not limited to all Clean Water Act Section 303(d) impaired water bodies; areas designated as Areas of Special Biological Significance by the State Water Board and SDRWQCB; State Water Quality Protected Areas; water bodies designated with the RARE beneficial use by the State Water Board and SDRWQCB; and any other equivalent environmentally sensitive areas which have been identified by the Copermittees.
<b>Filter Course</b>	Aggregate used to prevent particle migration between two different materials when storm water runoff passes through.

<b>Filter Fabric</b>	A permeable textile material, also termed a non-woven geotextile, that prevents particle migration between two different materials when storm water runoff passes through.
<b>Filtration</b>	Controlled seepage of storm water runoff through media, vegetation, or aggregate to reduce pollutants via physical separation.
<b>Flow Control</b>	Control of runoff rates and durations as required by the HMP.
<b>Flow Control BMP</b>	A structural BMP designed to provide control of post-project runoff flow rates and durations for the purpose of hydromodification management.
<b>Flow-thru Treatment</b>	Treatment from a BMP meeting the flow-thru treatment control standard.
<b>Flow-Thru Treatment BMPs</b>	Flow-thru treatment control BMPs are structural, engineered facilities that are designed to remove pollutants from storm water runoff using treatment processes that do not incorporate significant biological methods. Flow-thru BMPs include vegetated swales, media filters, sand filters, and dry extended detention basins. (See Section 5.5.4 for illustration and additional information).
<b>Forebay</b>	An initial storage area at the entrance to a structural BMP designed to trap and settle out solid pollutants such as sediment in a concentrated location, to provide pre-treatment within the structural BMP and facilitate removal of solid pollutants during maintenance operations.
<b>Full Infiltration</b>	Infiltration of a storm water runoff volume equal to the DCV.
<b>Geomorphic Assessment</b>	A quantification or measure of the changing properties of a stream channel.
<b>Geomorphically Significant Flows</b>	Flows that have the potential to cause, or accelerate, stream channel erosion or other adverse impacts to beneficial stream uses. The range of geomorphically significant flows was determined as part of the development of the March 2011 Final HMP, and has not changed under the 2013 MS4 Permit. However, under the 2013 MS4 Permit, Q2 and Q10 must be based on the pre-development condition rather than the pre-project condition, meaning that no pre-project impervious area may be considered in the computation of pre-development Q2 and Q10.

<b>GLUs</b>	Classifications that provide an estimate of sediment yield based upon three factors: geology, hillslope, and land cover. GLUs are developed based on the methodology presented in the SCCWRP Technical Report 605 titled “Hydromodification Screening Tools: GIS-Based Catchment Analyses of Potential Changes in Runoff and Sediment Discharge” (SCCWRP, 2010).
<b>Gross Pollutants</b>	In storm water, generally litter (trash), organic debris (leaves, branches, seeds, twigs, grass clippings), and coarse sediments (inorganic breakdown products from soils, pavement, or building materials).
<b>Harvest and Use BMP</b>	Harvest and use (aka rainwater harvesting) BMPs capture and store storm water runoff for later use. These BMPs are engineered to store a specified volume of water and have no design surface discharge until this volume is exceeded. (See Section 5.5.1.1 for illustration and additional information).
<b>HMP</b>	A plan implemented by the Copermittees so that post-project runoff shall not exceed estimated pre-development rates and/or durations by more than 10%, where increased runoff would result in increased potential for erosion or other adverse impacts to beneficial uses. The March 2011 Final HMP and the updated MS4 Permit are the basis of the flow control requirements of this manual.
<b>Hungry Water</b>	Also known as "sediment-starved" water, "hungry" water refers to channel flow that is hungry for sediment from the channel bed or banks because it currently contains less bed material sediment than it is capable of conveying. The “hungry water” phenomenon occurs when the natural sediment load decreases and the erosive force of the runoff increases as a natural counterbalance, as described by Lane’s Equation.
<b>Hydraulic Head</b>	Energy represented as a difference in elevation, typically as the difference between the inlet and outlet water surface elevation for a BMP.
<b>Hydraulic Residence Time</b>	The length of time between inflow and outflow that runoff remains in a BMP.
<b>Hydrologic Soil Group</b>	Classification of soils by the Natural Resources Conservation Service (NRCS) into A, B, C, and D groups according to infiltration capacity.

<b>Hydromodification</b>	<p>The change in the natural watershed hydrologic processes and runoff characteristics (i.e., interception, infiltration, overland flow, interflow and groundwater flow) caused by urbanization or other land use changes that result in increased stream flows and sediment transport. In addition, alteration of stream and river channels, installation of dams and water impoundments, and excessive stream-bank and shoreline erosion are also considered hydromodification, due to their disruption of natural watershed hydrologic processes.</p>
<b>Hydromodification Management BMP</b>	<p>A structural BMP for the purpose of hydromodification management, either for protection of critical coarse sediment yield areas or for flow control. See also flow control BMP.</p>
<b>Impervious Surface</b>	<p>Any material that prevents or substantially reduces infiltration of water into the soil.</p>
<b>Infeasible</b>	<p>As applied to BMPs, refers to condition in which a BMP approach is not practicable based on technical constraints specific to the site, including by not limited to physical constraints, risks of impacts to environmental resources, risks of harm to human health, or risk of loss or damage to property. Feasibility criteria are provided in this manual.</p>
<b>Infiltration</b>	<p>In the context of LID, infiltration is defined as the percolation of water into the ground. Infiltration is often expressed as a rate (inches per hour), which is determined through an infiltration test. In the context of non-storm water, infiltration is water other than wastewater that enters a sewer system (including sewer service connections and foundation drains) from the ground through such means as defective pipes, pipe joints, connections, or manholes. Infiltration does not include, and is distinguished from, inflow [40 CFR 35.2005(20)].</p>
<b>Infiltration BMP</b>	<p>Infiltration BMPs are structural measures that capture, store and infiltrate storm water runoff. These BMPs are engineered to store a specified volume of water and have no design surface discharge (underdrain or outlet structure) until this volume is exceeded. These types of BMPs may also support evapotranspiration processes, but are characterized by having their most dominant volume losses due to infiltration. (See Section 5.5.1.2 for illustration and additional information).</p>



<b>Jurisdiction</b>	The term “jurisdiction” is used in this manual to refer to individual copermitttees who have independent responsibility for implementing the requirements of the MS4 Permit.
<b>LID</b>	A storm water management and land development strategy that emphasizes conservation and the use of onsite natural features integrated with engineered, small-scale hydrologic controls to more closely reflect pre-development hydrologic functions. See Site Design.
<b>Lower Flow Threshold</b>	The lower limit of the range of flows to be controlled for hydromodification management. The lower flow threshold is the flow at which erosion of sediment from the stream bed or banks begins to occur. See also critical channel flow. For the San Diego region, the lower flow threshold shall be a fraction (0.1, 0.3, or 0.5) of the pre-development 2-year flow rate based on continuous simulation modeling (0.1Q2, 0.3Q2, or 0.5Q2).
<b>Media</b>	Storm water runoff pollutant treatment material, typically included as a permeable constructed bed or container (cartridge) within a BMP.
<b>MEP</b>	Refer to the definition in the MS4 Permit. [Appendix C, Definitions, Page C-6]
<b>National Pollutant Discharge Elimination System</b>	The national program for issuing, modifying, revoking and reissuing, terminating, monitoring and enforcing permits, and imposing and enforcing pretreatment requirements, under Sections 307, 318, 402, and 405 of the Clean Water Act.
<b>New Development</b>	Land disturbing activities; structural development, including construction or installation of a building or structure, the creation of impervious surfaces; and land subdivision.
<b>O&amp;M</b>	Requirements in the MS4 Permit to inspect structural BMPs and verify the implementation of operational practices and preventative and corrective maintenance in perpetuity.
<b>Partial Infiltration</b>	Infiltration of a storm water runoff volume less than the DCV.
<b>Partial Retention</b>	Partial retention category is defined by structural measures that incorporate both infiltration (in the lower treatment zone) and biofiltration (in the upper treatment zone).

<b>PDPs</b>	As defined by the MS4 Permit provision E.3.b, land development projects that fall under the planning and building authority of the Copermittee for which the Copermittee must impose specific requirements in addition to those required of Standard Projects. Refer to Section 1.4 to determine if your project is a PDP.
<b>PDPs with only Pollutant Control Requirements</b>	PDPs that need to meet Source Control, Site Design and Pollutant Control Requirements (but are exempt from Hydromodification Management Requirements).
<b>PDPs with Pollutant Control and Hydromodification Management Requirements</b>	PDPs that need to meet Source Control, Site Design, Pollutant Control and Hydromodification Management Requirements.
<b>Point of Compliance</b>	1. For channel screening and determination of low flow threshold: the point at which collected storm water from a development is delivered from a constructed or modified drainage system into a natural or un-lined channel. POC for channel screening may be located onsite or offsite, depending on where runoff from the project meets a natural or un-lined channel. 2. For flow control: the point at which pre-development and post-development flow rates and durations will be compared. POC for flow control is typically onsite. A project may have a different POC for channel screening vs. POC for flow control if runoff from the project site is conveyed in hardened systems from the project site boundary to the natural or un-lined channel.
<b>Pollutant Control</b>	Control of pollutants via physical, chemical or biological processes
<b>Pollution Prevention</b>	Pollution prevention is defined as practices and processes that reduce or eliminate the generation of pollutants, in contrast to source control BMPs, treatment control BMPs, or disposal.
<b>Post-Project Hydrology Flows, Volumes</b>	The peak runoff flows and runoff volume anticipated after the project has been constructed taking into account all permeable and impermeable surfaces, soil and vegetation types and conditions after landscaping is complete, detention or retention basins or other water storage elements incorporated into the site design, and any other site features that would affect runoff volumes and peak flows.

<b>Potential Critical Coarse Sediment Yield Area</b>	A GLU with coarse-grained geologic material and high relative sediment production, as defined in the Regional WMAA. The Regional WMAA identified GLUs as potential critical coarse sediment yield areas based on slope, geology, and land cover. GLU analysis does not determine whether the sediment produced is critical to the receiving stream (a source of bed material to the receiving stream) therefore the areas are designated as potential.
<b>Pre-Development Runoff Conditions</b>	Approximate flow rates and durations that exist or existed onsite before land development occurs. For new development projects, this equates to runoff conditions immediately before any new project disturbance or grading. For redevelopment projects, this equates to runoff conditions from the project footprint assuming infiltration characteristics of the underlying soil, and existing grade. Runoff coefficients of concrete or asphalt must not be used. A redevelopment PDP must use available information pertaining to existing underlying soil type and onsite existing grade to estimate pre-development runoff conditions.
<b>Pre-Project Condition</b>	The condition prior to any project work or the existing condition. Note that pre-project condition and pre-development condition will not be the same for redevelopment projects.
<b>Pretreatment</b>	Removal of gross solids, including organic debris and coarse sediment, from runoff to minimize clogging and increase the effectiveness of BMPs.
<b>Project Area</b>	All areas proposed by an applicant to be altered or developed, plus any additional areas that drain on to areas to be altered or developed. Also see Section 1.3.
<b>Project Submittal</b>	Documents submitted to a jurisdiction or Copermittee in connection with an application for development approval and demonstrating compliance with MS4 Permit requirements for the project. Specific requirements vary from municipality to municipality.
<b>Proprietary BMP</b>	BMP designed and marketed by private business for treatment of storm water. Check with City Engineer prior to proposing to use a proprietary BMP.
<b>Receiving Waters</b>	See Waters of the United States.

**Redevelopment** The creation and/or replacement of impervious surface on an already developed site. Examples include the expansion of a building footprint, road widening, and the addition to or replacement of a structure. Replacement of impervious surfaces includes any activity where impervious material(s) are removed, exposing underlying soil during construction. Redevelopment does not include routine maintenance activities, such as trenching and resurfacing associated with utility work; pavement grinding; resurfacing existing roadways, sidewalks, pedestrian ramps, or bike lanes on existing roads; and routine replacement of damaged pavement, such as pothole repair.

**Retrofitting** Storm water management practice put into place after development has occurred in watersheds where the practices previously did not exist or are ineffective. Retrofitting of developed areas is intended to improve water quality, protect downstream channels, reduce flooding, or meet other specific objectives. Retrofitting developed areas may include, but is not limited to replacing roofs with green roofs, disconnecting downspouts or impervious surfaces to drain to pervious surfaces, replacing impervious surfaces with pervious surfaces, installing rain barrels, installing rain gardens, and trash area enclosures.

**Regional Water Quality Control Board (SDRWQCB)** California RWQCBs are responsible for implementing pollution control provisions of the Clean Water Act and California Water Code within their jurisdiction. There are nine California RWQCBs.

**Retention (Retention BMPs)** A category of BMP that does not have any service outlets that discharge to surface water or to a conveyance system that drains to surface waters for the design event (i.e. 85<sup>th</sup> percentile 24-hour). Mechanisms used for storm water retention include infiltration, evapotranspiration, and use of retained water for non-potable or potable purposes.

**Saturated Storage** Storage that provides a permanent volume of water at the bottom of the BMP as an anaerobic zone to promote denitrification and/or thermal pollution control. Also known as internal water storage or a saturation zone.

**Self-mitigating Areas** A natural, landscaped, or turf area that does not generate significant pollutants and drains directly offsite or to the public storm drain system without being treated by a structural BMP. See Section 5.2.1.

**Self-retaining DMA via Qualifying Site Design BMPs** An area designed to retain runoff to fully eliminate storm water runoff from the 85<sup>th</sup> percentile 24 hours storm event; See Section 5.2.3.

**SIC** A Federal government system for classifying industries by 4-digit code. It is being supplanted by the North American Industrial Classification System but SIC codes are still referenced by the Regional Water Board in identifying development sites subject to regulation under the National Pollutant Discharge Elimination System permit. Information and an SIC search function are available at <https://www.osha.gov/pls/imis/sicsearch.html>

**Significant Redevelopment** Redevelopment that meets the definition of a “PDP” in this manual. See Section 1.4.

**Site Design** A storm water management and land development strategy that emphasizes conservation of natural features and the use of onsite natural features integrated with engineered, small-scale hydrologic controls to more closely reflect pre-development hydrologic functions.

**Sizing Factor Method** A method for designing flow control BMPs for hydromodification management using sizing factors developed from unit area continuous simulation models.

**Sorption** Physical and/or chemical process where pollutants are taken out of runoff through attachment to another substance.

**Source Control** Land use or site planning practices, or structures that aim to prevent runoff pollution by reducing the potential for contamination at the source of pollution. Source control BMPs minimizes the contact between pollutants and storm water runoff. Examples include roof structures over trash or material storage areas, and berms around fuel dispensing areas. Source control BMPs are described within this manual.

**Standard Project** Any development project that is not defined as a PDP by the MS4 Permit.

**Storm Water  
Conveyance System**

A conveyance or system of conveyances (including roads with drainage systems, municipal streets, catch basins, curbs, gutters, ditches, man-made channels, or storm drains): (i) Owned or operated by a State, city, town, borough, county, parish, district, association, or other public body (created by or pursuant to State law) having jurisdiction over disposal of sewage, industrial wastes, storm water, or other wastes, including special districts under State law such as a sewer district, flood control district or drainage district, or similar entity, or an Indian tribe or an authorized Indian tribal organization, or designated and approved management agency under section 208 of the Clean Water Act that discharges to waters of the United States; (ii) Designated or used for collecting or conveying storm water; (iii) Which is not a combined sewer; (iv) Which is not part of the Publicly Owned Treatment Works as defined at 40 CFR 122.26.

**Storm Water Pollutant  
Control BMP**

A category of storm water management requirements that includes treatment of storm water to remove pollutants by measures such as retention, biofiltration, and/or flow-thru treatment control, as specified in this manual. Also called a Pollutant Control BMP.

**Structural BMP**

Throughout the manual, the term "structural BMP" is a general term that encompasses the pollutant control BMPs and hydromodification BMPs required for PDPs under the MS4 Permit. A structural BMP may be a pollutant control BMP, a hydromodification management BMP, or an integrated pollutant control and hydromodification management BMP. Structural BMPs as defined in the MS4 Permit are: a subset of BMPs which detains, retains, filters, removes, or prevents the release of pollutants to surface waters from development projects in perpetuity, after construction of a project is completed.

**Subgrade**

In-situ soil that lies underneath a BMP.

**Tributary Area**

The total surface area of land or hardscape that contributes runoff to the BMP; including any offsite or onsite areas that comingle with project runoff and drains to the BMP. Refer to Section 3.3.3 for additional guidance Also termed the drainage area or catchment area.

**Unified BMP Design Approach**

This term refers to the standardized process for site and watershed investigation, BMP selection, BMP sizing, and BMP design that is outlined and described in this manual with associated appendices and templates. This approach is considered to be “unified” because it represents a pathway for compliance with MS4 Permit requirements that is anticipated to be reasonably consistent across the local jurisdictions in San Diego County. In contrast, applicants may choose to take an alternative approach where they demonstrate to the satisfaction of the Copermittee, in their submittal, compliance with applicable performance standards without necessarily following the process identified in this manual.

**Upper Flow Threshold**

The upper limit of the range of flows to be controlled for hydromodification management. For the San Diego region, the upper flow threshold shall be the pre-development 10-year flow rate (Q10) based on continuous simulation modeling.

**Vactor**

Refers to a sewer or storm drain cleaning truck equipped to remove materials from sewer or storm drain pipes or structures, including some storm water BMPs.

**Vector**

An animal or insect capable of transmitting the causative agent of human disease. An example of a vector in San Diego County that is of concern in storm water management is a mosquito.

**Water Quality Improvement Plan**

Copermittees are required to develop a Water Quality Improvement Plan for each Watershed Management Area in the San Diego Region. The purpose of the Water Quality Improvement Plans is to guide the Copermittees’ jurisdictional runoff management programs towards achieving the outcome of improved water quality in MS4 discharges and receiving waters. WQIPs requirements are defined in the MS4 Permit provision B.

**Waters of the United States**

Surface bodies of water, including naturally occurring wetlands, streams (perennial, intermittent, and ephemeral (exhibiting bed, bank, and ordinary high water mark)), creeks, rivers, reservoirs, lakes, lagoons, estuaries, harbors, bays and the Pacific Ocean which directly or indirectly receive discharges from storm water conveyance systems. The Copermittee shall determine the definition for wetlands and the limits thereof for the purposes of this definition, which shall be as protective as the Federal definition utilized by the United States Army Corps of Engineers and the United States Environmental Protection Agency. Constructed wetlands are not considered wetlands under this definition, unless the wetlands were constructed as mitigation for habitat loss. Other constructed BMPs are not considered receiving waters under this definition, unless the BMP was originally constructed within the boundaries of the receiving waters. Also see MS4 permit definition.

**Watershed Management Area**

The ten areas defined by the SDRWQCB in Regional MS4 Permit provision B.1, Table B-1. Each Watershed Management Area is defined by one or more Hydrologic Unit, major surface water body, and responsible Copermittee.

**Watershed Management Area Analysis**

For each Watershed Management Area, the Copermittees have the option to perform a WMAA for the purpose of developing watershed-specific requirements for structural BMP implementation. Each WMAA includes: GIS layers developed to provide physical characteristics of the watershed management area, a list of potential offsite alternative compliance projects, and areas exempt from hydromodification management requirements.