

PLANNING COMMISSION

Agenda Item No.: G.2
Date: May 22, 2012

CASE NUMBER: PHG 12-0006

APPLICANT: Mark Phillips, M&M Telecom, Inc. (Verizon Wireless)

LOCATION: An approximately 3.20-acre property generally located on the southern side of West Citracado Parkway, east of Interstate 15, addressed as 625 West Citracado Parkway (APN 238-110-43).

TYPE OF PROJECT: Modification to a Master and Precise Development Plan

PROJECT DESCRIPTION: A modification to a previously approved Master and Precise Development Plan for Verizon to install up to twelve wireless communication panel antennas and associated support equipment behind existing mechanical screen walls on the roof of the Rady Children's Urgent Care Facility. The existing trash enclosure area adjacent to the building would be modified to house new electrical equipment and a 20 KW standby emergency generator. A new trash enclosure would be constructed towards southwestern area of the site.

STAFF RECOMMENDATION: Approval

GENERAL PLAN DESIGNATION/TIER: Planned Commercial; Tier 1- Kit Carson subarea

ZONING: PD-C (Planned Development-Commercial)

BACKGROUND/SUMMARY OF ISSUES:

A Master and Precise Development Plan (Case No. 2004-01-PD) previously was approved by the City Council for the development of a 48,800 SF pediatric medical center (Rady Children's Urgent Care) on the subject property. Verizon Wireless is requesting to locate a new wireless communication facility consisting of up to twelve panel antennas and support equipment on the roof of the existing medical building. The project involves only minor changes to the exterior of the building and the site to accommodate the wireless facility. There currently are no wireless communication facilities located on the building or site. A previous modification to the Master Plan was approved in 2010 for Clearwire to install up to nine panel antennas on the roof of the facility, but the panels never were installed and the project subsequently expired. The Rady medical facility is zoned Planned Development Commercial and therefore a modification to the Master Plan is necessary to allow a wireless facility to be located on the site.

LEGAL REQUIREMENTS: In 1996, the U.S. Congress added a section to the Communications Act of 1934 to promote the expansion of personal wireless communications service, adding section 332(c)(7). This section preserves local zoning authority over the "placement, construction, and modification" of wireless facilities, while imposing certain federal requirements. Specifically, Section 332(c)(7) requires that state or local government decisions regarding wireless service facilities must not: 1) unreasonably discriminate between one cellular provider and another; or 2) prohibit or have the effect of prohibiting the provision of personal wireless services; or 3) be founded on "the environmental effects of radio frequency (RF) emissions *to the extent that such facilities comply* with the FCC's regulations" (emphasis added).

In summary, once the Commission is satisfied the project's RF emissions are within the federal thresholds, then the review must be based on otherwise applicable local zoning criteria. A denial of a proposed facility must not run afoul of the federal restrictions set forth as 1), 2) and 3) above.

Staff feels the issues are as follows:

1. Whether the design and location of the proposed facility is appropriate for the site and consistent with the Wireless Facility Guidelines.

REASONS FOR STAFF RECOMMENDATION:

1. The proposed facility would be consistent with the Communication Antennas Ordinance since it would be located within a commercial building and entirely integrated into the architecture of the existing building. The proposed design would not result in any adverse visual impacts and would be in scale and context with the built environment.
2. Staff feels the proposed facility would not result in potential health hazards to nearby residents since the Radio Frequency (RF) study prepared for the proposed project indicates the facility would be within maximum permissible exposure (MPE) limits and Federal Communication Commission (FCC) standards.

Respectfully submitted,



Jay Paul
Associate Planner

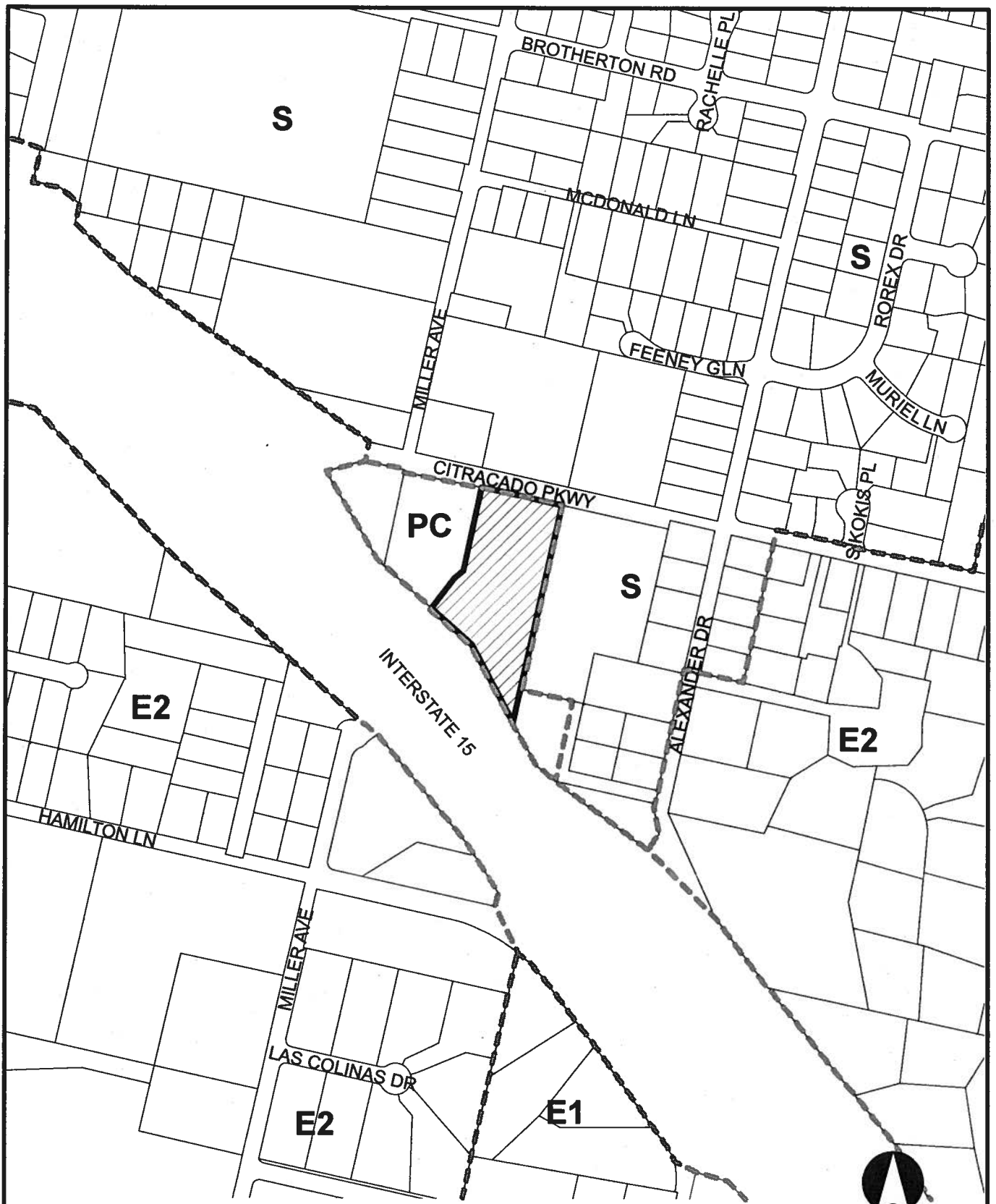

Portions of this DERIVED PRODUCT contains geographic information copyrighted by SanGIS. All rights reserved.

**PROPOSED PROJECT
PHG 12-0006**



GENERAL PLAN

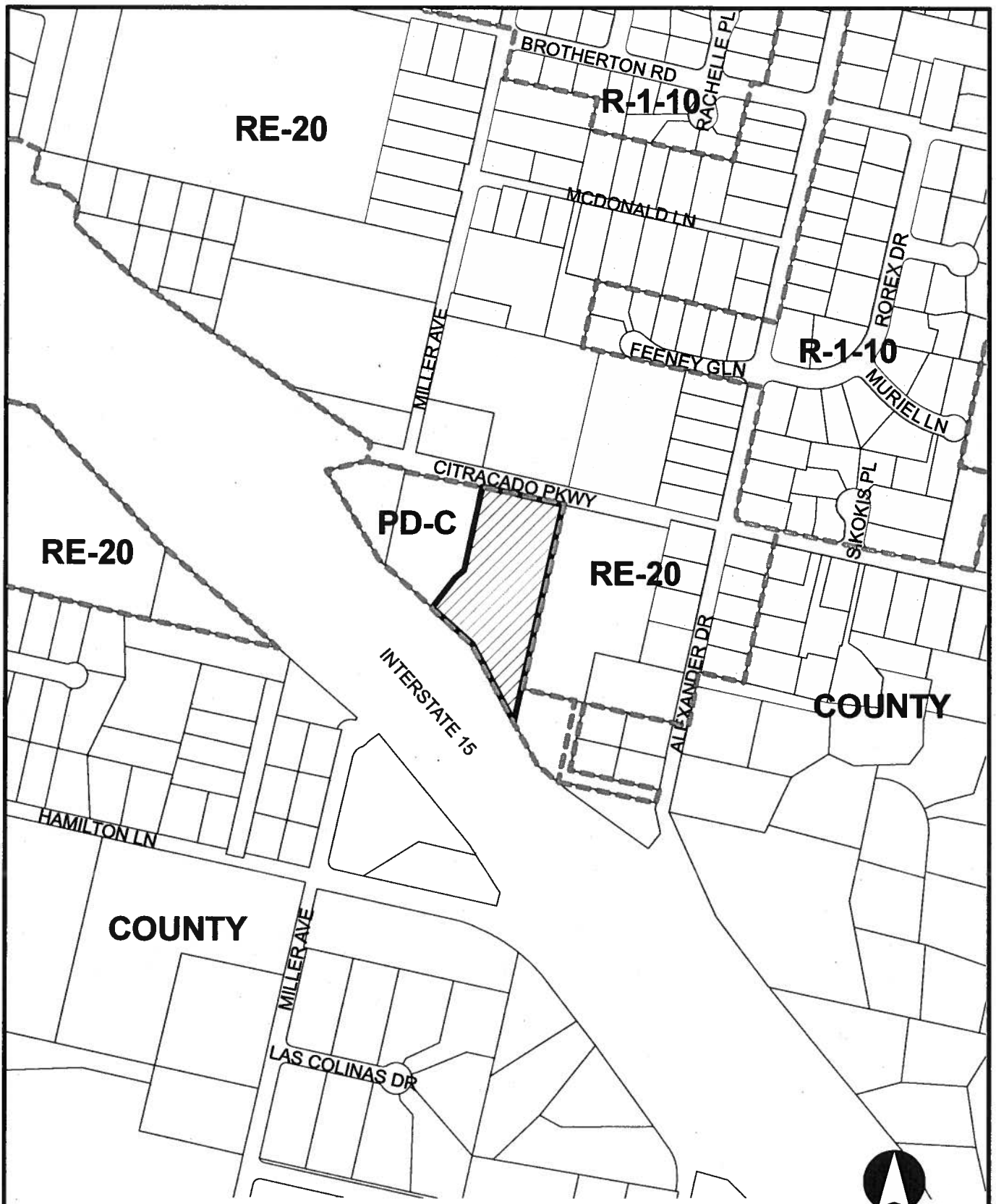

Portions of this DERIVED PRODUCT contains geographic information copyrighted by SanGis. All rights reserved.

**PROPOSED PROJECT
PHG 12-0006**



LOCATION/ZONING

ANTENNA PLAN NOTES:

- 1 PROPOSED VERIZON WIRELESS ANTENNAS TO BE PIPE MOUNTED BEHIND NEW RF TRANSPARENT SCREENS
- 2 PROPOSED SHROUD
- 3 PROPOSED R.F. TRANSPARENT PANELS & FRAMING TO BE DETAILED, TEXTURED, & PAINTED TO MATCH EXISTING MECHANICAL SCREEN WALL
- 4 PROPOSED UNISTRUT FRAME
- 5 PROPOSED STEEL PLATE (GALV.)
- 6 PROPOSED COAXIAL CABLE TRAY ON PVC SLEEPERS
- 7 PROPOSED COAX CABLE CHASE FROM EQUIPMENT SHELTER TO LOWER ROOF. CABLE CHASE TO BE STUCCO DETAILED, TEXTURED & PAINTED TO MATCH EXISTING BUILDING ADJACENT WALL
- 8 PROPOSED COAX CABLE CHASE FROM LOWER ROOF TO BUILDING ROOF. CABLE CHASE TO BE STUCCO DETAILED, TEXTURED, & PAINTED TO MATCH EXISTING BUILDING ADJACENT WALL
- 9 EXISTING UTILITY CONDUIT MOUNTED ON ROOF
- 10 EXISTING ROOF HATCH (ROOF ACCESS)
- 11 EXISTING BUILT-UP ROOF (TYPICAL)
- 12 EXISTING ROOF TOP MECHANICAL EQUIPMENT
- 13 EXISTING ROOF VENT (TYP.)
- 14 EXISTING EXHAUST VENT (TYP.)
- 15 EXISTING ROOF DRAIN AND OVERFLOW (TYPICAL)
- 16 EXISTING BUILDING PARAPET WALL WITH SHEET METAL CAP
- 17 EXISTING MECHANICAL SCREEN WALL
- 18 EXISTING STEEL COLUMN
- 19 EXISTING SCREEN WALL FRAMING STEEL BEAM
- 20 EXISTING SCREEN WALL FRAMING STEEL BEAM ABOVE (SHOWN DASHED)
- 21 EXISTING VERTICAL CONTROL JOINT
- 22 EXISTING ELECTRICAL CONDUIT MOUNTED TO WALL
- 23 EXISTING WALL MOUNTED LIGHT FIXTURE TO REMAIN
- 24 EXISTING WALL MOUNTED LIGHT FIXTURE TO BE RELOCATED (SHOWN DASHED)
- 25 PROPOSED RELOCATION OF EXISTING WALL MOUNTED LIGHT FIXTURE

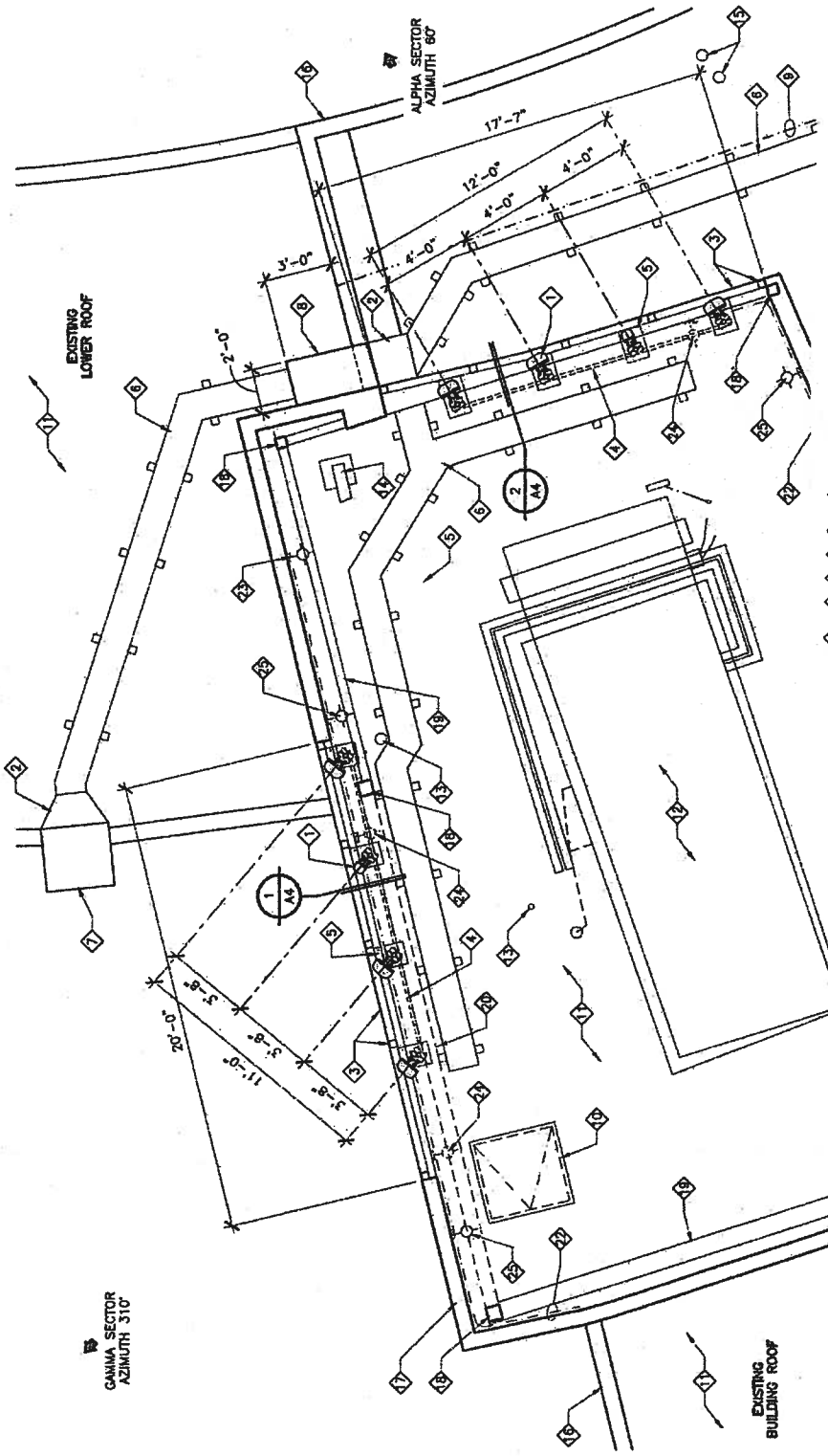

ANTENNA PLAN A

**PROPOSED PROJECT
PHG 12-0006**

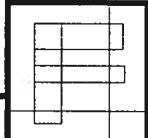

FLOOR PLAN

ANTENNA PLAN NOTES:

- ① PROPOSED VERIZON WIRELESS ANTENNAS TO BE PIPE MOUNTED BEHIND NEW RF TRANSPARENT SCREENS
- ② PROPOSED SHROUD
- ③ PROPOSED R.F. TRANSPARENT PANELS & FRAMING TO BE DETAILED, TEXTURED, & PAINTED TO MATCH EXISTING MECHANICAL SCREEN WALL
- ④ PROPOSED UNISTRUT FRAME
- ⑤ PROPOSED STEEL PLATE (GALV.)
- ⑥ PROPOSED COAXIAL CABLE TRAY ON PVC SLEEPERS
- ⑦ PROPOSED COAX CABLE CHASE FROM EQUIPMENT SHELTER TO LOWER ROOF. CABLE CHASE TO BE STUCCO DETAILED, TEXTURED, & PAINTED TO MATCH EXISTING BUILDING ADJACENT WALL
- ⑧ PROPOSED COAX CABLE CHASE FROM LOWER ROOF TO BUILDING ROOF. CABLE CHASE TO BE STUCCO DETAILED, TEXTURED, & PAINTED TO MATCH EXISTING BUILDING ADJACENT WALL
- ⑨ EXISTING UTILITY CONDUIT MOUNTED ON ROOF
- ⑩ EXISTING ROOF HATCH (ROOF ACCESS)
- ⑪ EXISTING BUILT-UP ROOF (TYPICAL)
- ⑫ EXISTING ROOF TOP MECHANICAL EQUIPMENT
- ⑬ EXISTING ROOF VENT (TYP.)
- ⑭ EXISTING EXHAUST VENT (TYP.)
- ⑮ EXISTING ROOF DRAIN AND OVERFLOW (TYPICAL)
- ⑯ EXISTING BUILDING PARAPET WALL WITH SHEET METAL CAP
- ⑰ EXISTING MECHANICAL SCREEN WALL
- ⑱ EXISTING STEEL COLUMN
- ⑲ EXISTING SCREEN WALL FRAMING STEEL BEAM
- ⑳ EXISTING SCREEN WALL FRAMING STEEL BEAM ABOVE (SHOWN DASHED)
- ㉑ EXISTING VERTICAL CONTROL JOINT
- ㉒ EXISTING ELECTRICAL CONDUIT MOUNTED TO WALL
- ㉓ EXISTING WALL MOUNTED LIGHT FIXTURE TO REMAIN
- ㉔ EXISTING WALL MOUNTED LIGHT FIXTURE TO BE RELOCATED (SHOWN DASHED)
- ㉕ PROPOSED RELOCATION OF EXISTING WALL MOUNTED LIGHT FIXTURE

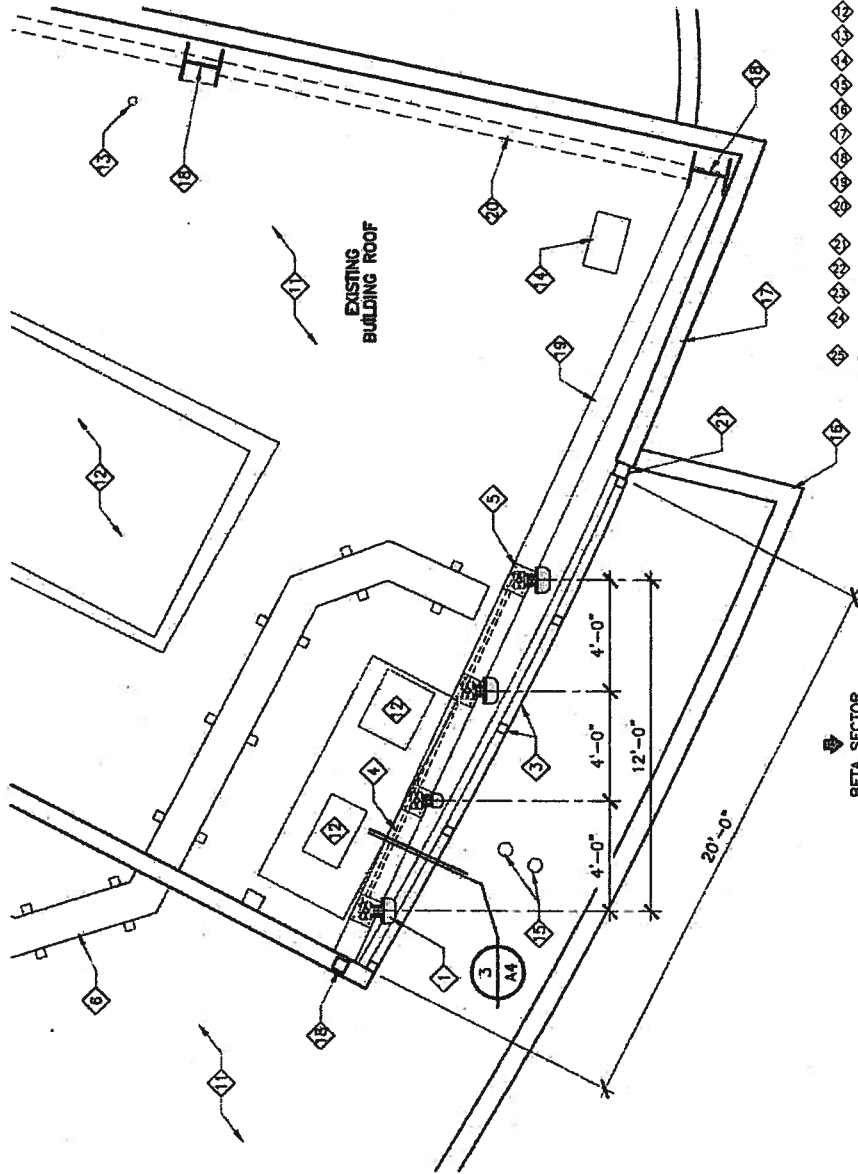

ANTENNA PLAN B

**PROPOSED PROJECT
PHG 12-0006**

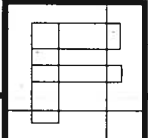

FLOOR PLAN

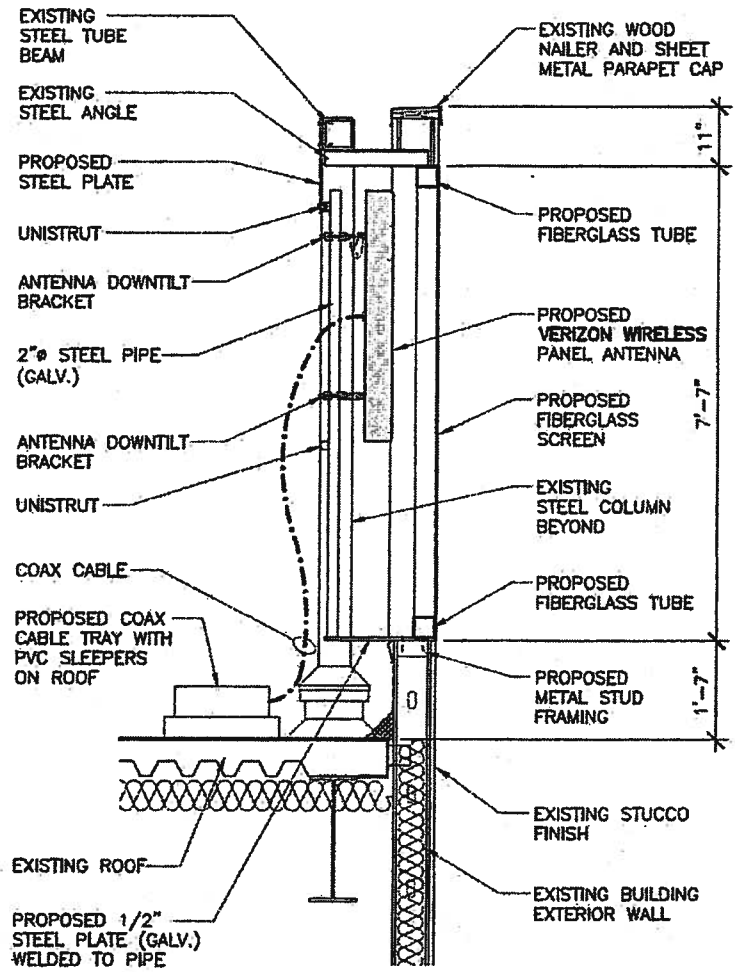

ANTENNA SECTION

**PROPOSED PROJECT
PHG 12-0006**

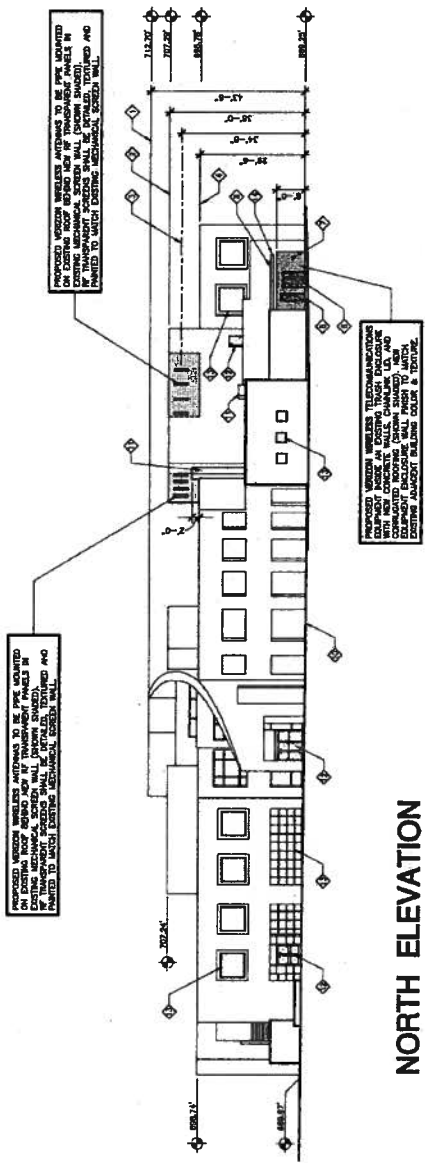

NORTH ELEVATION

PARTIAL NORTH ELEVATION

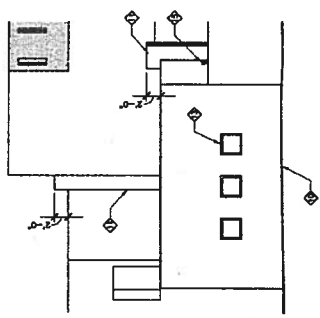

- ELEVATION NOTES:**
- ◆ TOP OF EXISTING BUILDING
 - ◆ TOP OF EXISTING MECHANICAL SCREENS
 - ◆ CENTERLINE OF PROPOSED VERIZON WIRELESS PANEL ANTENNAS
 - ◆ TOP OF EXISTING BUILDING PARAPET
 - ◆ PROPOSED 3'-0" WIDE STEEL LOCKABLE ACCESS GATE & FRAME WITH VERIZON WIRELESS SIGNAGE
 - ◆ PROPOSED PAIR 3'-10" WIDE STEEL LOCKABLE ACCESS GATES & FRAME WITH VERIZON WIRELESS SIGNAGE
 - ◆ PROPOSED VERIZON WIRELESS REVERSE GENERATOR RECEPTACLE MOUNTED TO WALL
 - ◆ PROPOSED CORRUGATED METAL COVER TO MATCH EXISTING TRASH ENCLOSURE METAL COVER
 - ◆ PROPOSED TRASH ENCLOSURE
 - ◆ EXISTING GRADE
 - ◆ PROPOSED COAX CABLE CHASE FROM LOWER ROOF TO BUILDING ROOF. CABLE CHASE TO BE STUCCO DETAILED, TEXTURED, & PAINTED TO MATCH EXISTING BUILDING ADJACENT WALL
 - ◆ EXISTING DOOR
 - ◆ EXISTING WINDOW (TYPICAL)
 - ◆ PROPOSED STEEL BEAM TO MATCH EXISTING TRASH ENCLOSURE BEAM
 - ◆ PROPOSED GPS ANTENNAS MOUNTED TO EXISTING BUILDING WALL (TYPICAL OF 3)

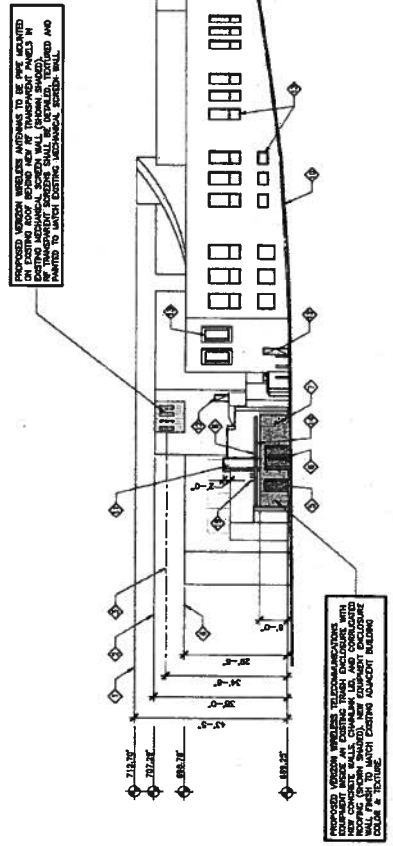

WEST ELEVATION

**PROPOSED PROJECT
PHG 12-0006**



ELEVATIONS

EXISTING ROOF MECHANICAL SCREEN WALL TO BE REPAIRED OR REPLACED WITH MECHANICAL SCREEN WALL IN EXISTING MECHANICAL SCREEN WALL (ROOM SHOWN). MECHANICAL SCREEN WALL TO BE REPAIRED AND PAINTED TO MATCH EXISTING MECHANICAL SCREEN WALL.

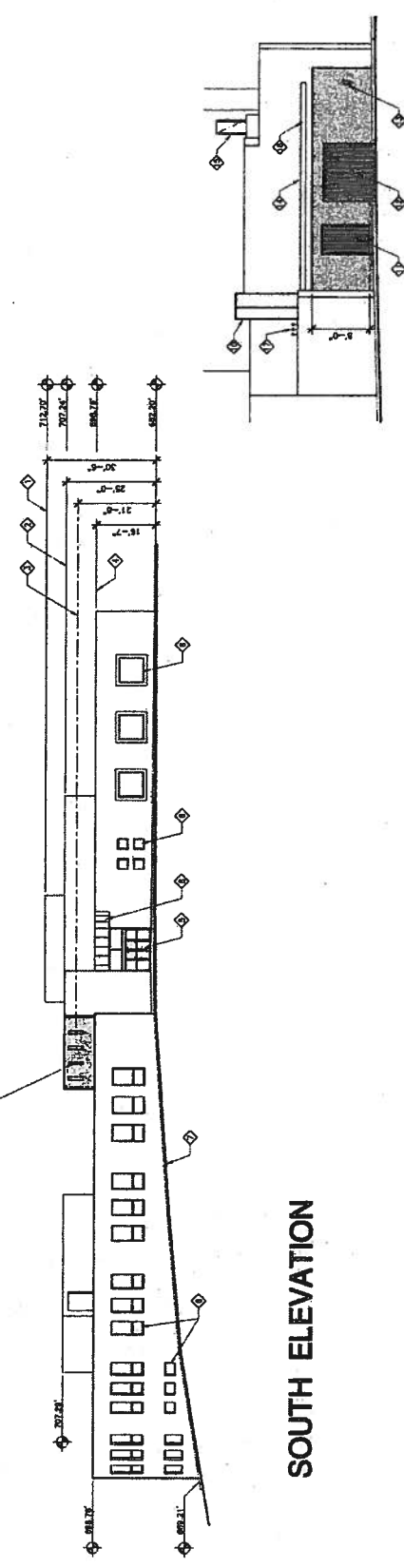

SOUTH ELEVATION

NORTHEAST ELEVATION

EXISTING ROOF MECHANICAL SCREEN WALL TO BE REPAIRED OR REPLACED WITH MECHANICAL SCREEN WALL IN EXISTING MECHANICAL SCREEN WALL (ROOM SHOWN). MECHANICAL SCREEN WALL TO BE REPAIRED AND PAINTED TO MATCH EXISTING MECHANICAL SCREEN WALL.

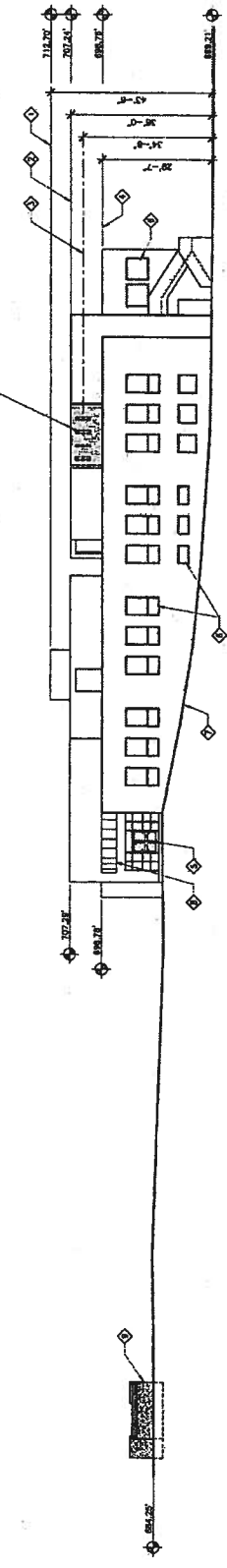

EAST ELEVATION

**PROPOSED PROJECT
PHG 12-0006**



ELEVATIONS

PLANT LIST (TO BE REMOVED)	
SCIENTIFIC NAME	COMMON NAME
1. ECHINUM CANDICANS	PRIDE OF MADERA
2. PELARGONIUM PELTATUM	IVY GERANIUM
3. MYOPORUM PARMIFOLIUM	CREEPING MYOPORUM

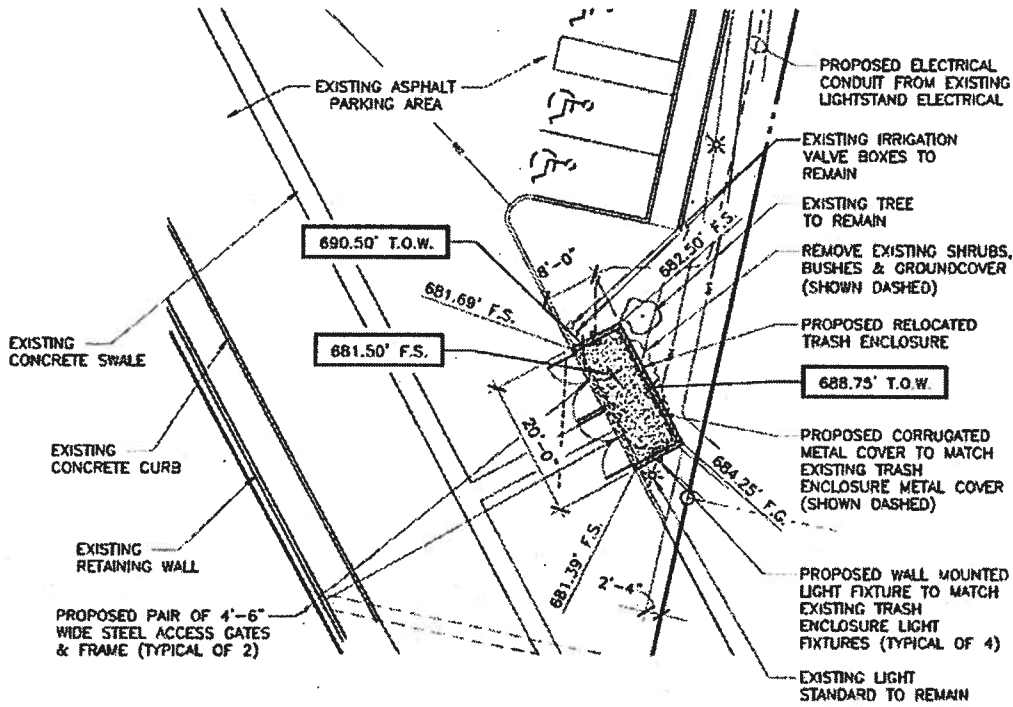

ENLARGED TRASH ENCLOSURE PLAN



**PROPOSED PROJECT
PHG 12-0006**



SITE PLAN

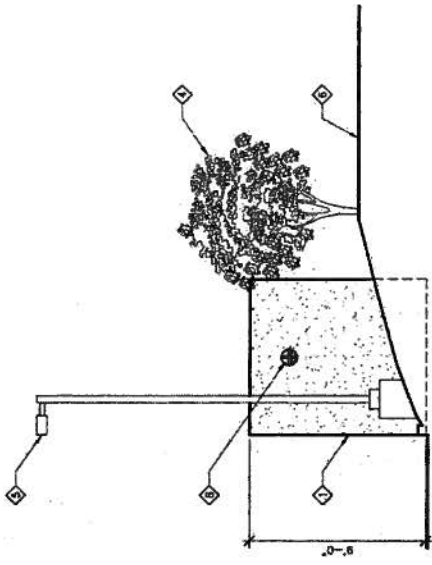

SOUTH ELEVATION

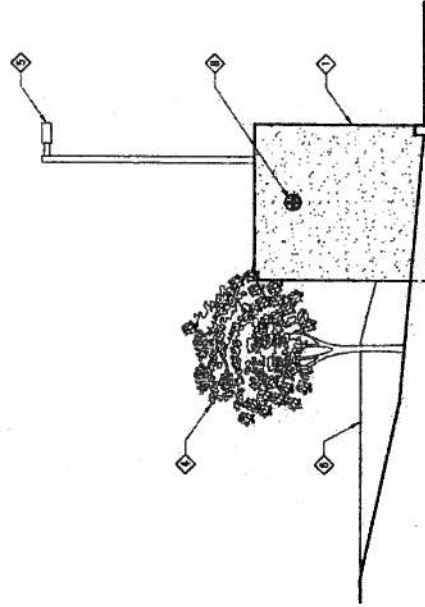

SOUTH ELEVATION

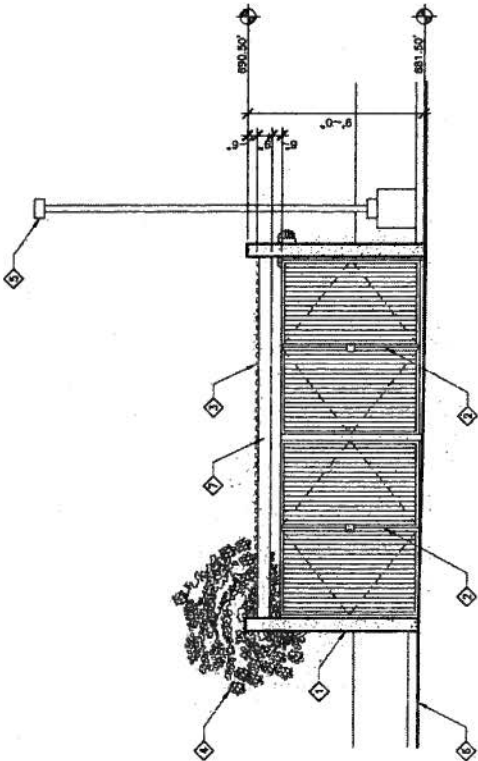

WEST ELEVATION

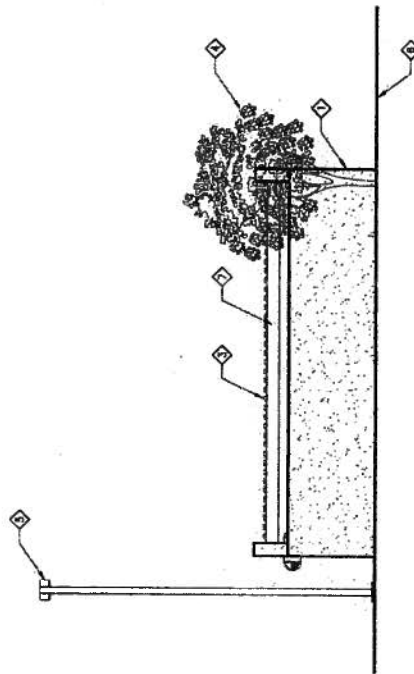

WEST ELEVATION

**PROPOSED PROJECT
PHG 12-0006**



ELEVATIONS

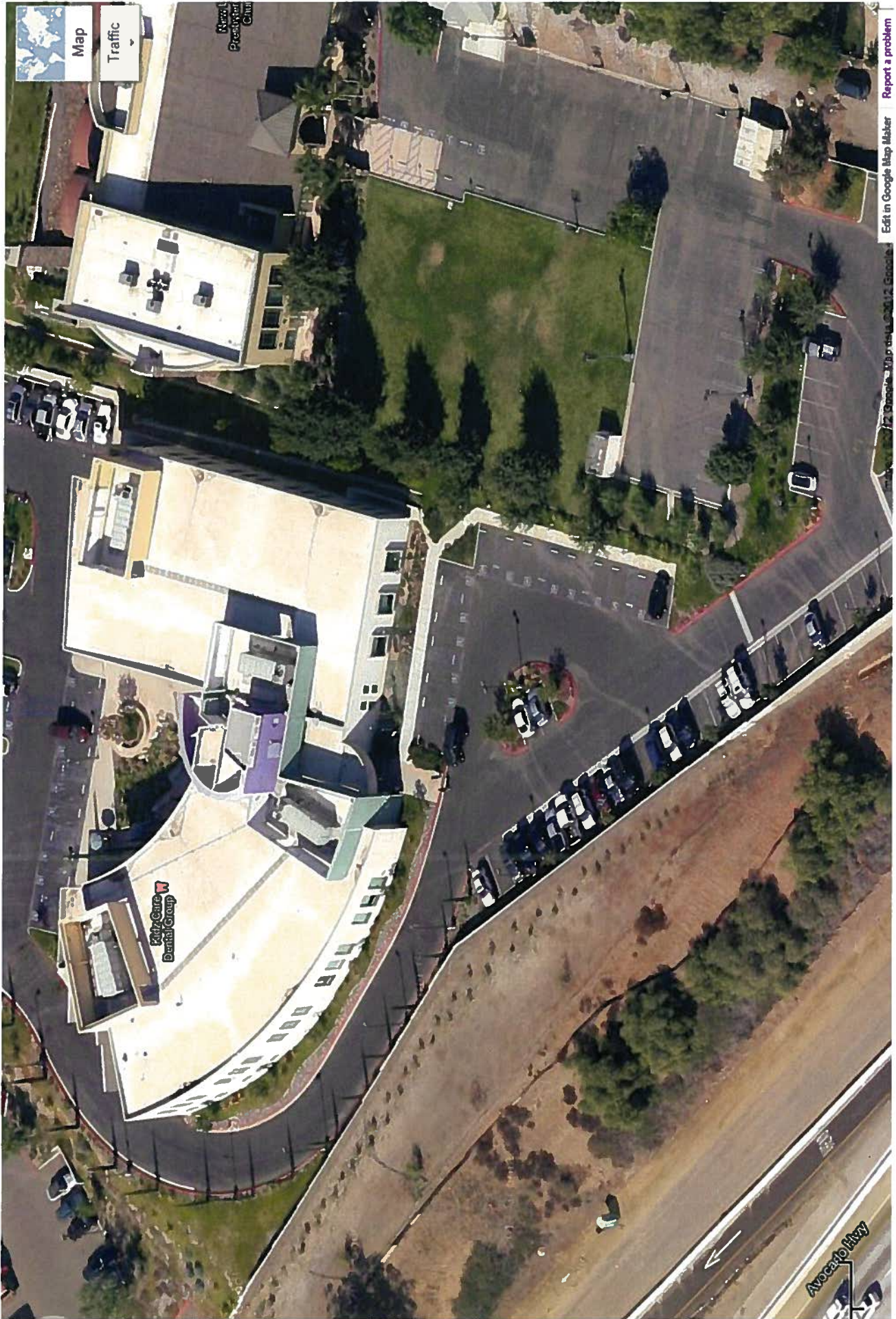

ANALYSIS

A. LAND USE COMPATIBILITY/SURROUNDING ZONING

NORTH - RE-20 (Residential Estate, 20,000 SF min. lot size) / An existing farm/produce stand and vacant property existing to the north across Citracado Parkway.

SOUTH - Interstate 15 is located immediately to the south and County zoned residential property is located further to the southeast.

EAST - RE-20 zoning (Residential Estate, 20,000 SF min. lot size) / An existing church facility is located to the east of the property. There are two wireless facilities located on the church site (T-Mobile and AT&T). Single-family homes are located to the southeast.

WEST - PD-C zoning and Interstate 15 / (Planned Development Commercial) / The Acacia Animal Hospital is located immediately west of the site.

B. ENVIRONMENTAL STATUS

1. The proposal is exempt from the requirements of the California Environmental Quality Act (CEQA) in conformance with Section 15303, "New Construction or Conversion of Small Structures" and a Notice of Exemption was prepared for the proposed project. In staff's opinion, the request does not have the potential for causing a significant effect on the environment due to the relatively small size of the facility; is within a secured location, and the proposed facility would be located on the roof of an existing commercial/office building behind existing mechanical equipment screening.
2. In staff's opinion, no significant issues remain unresolved through compliance with code requirements and the recommended conditions of approval. Staff feels the proposed facility would not result in a potential health hazards to nearby residents since the Radio Frequency (RF) study prepared for the proposed project indicates the facility would be within maximum permissible exposure (MPE) limits and Federal Communication Commission (FCC) standards.

C. GENERAL PLAN ANALYSIS:

General Plan - The requested Modification to the Planned Development is consistent with the Planned Commercial designation of the General Plan since the Communication Antennas Ordinance encourages wireless facilities to locate within commercial or industrial zones. The project is in conformance with relevant General Plan criteria and underlying Planned Commercial zone standards, as detailed in various sections of the staff report. The proposed project would be integrated into the existing architecture of the building and would be a completely stealthy design.

D. PROJECT ANALYSIS

Appropriateness of the Proposed Design and Whether the Proposed Wireless Facility Would Be in Conformance with the Communication Antennas Ordinance

Verizon Wireless is proposing to install a new wireless communication facility on the roof of the existing Rady two-story medical building. The proposed facility consists of up to twelve antennas and corresponding radio equipment located within two fully screened rooftop mechanical areas. The new facility generally would not be visible to any nearby surrounding views. Portions of the existing mechanical screen walls would be replaced with new RF transparent materials that would be blended into the walls and colored and textured to match the exterior stucco walls. An existing trash enclosure area located towards the northwestern corner of the building would be modified to house the support electrical equipment and an emergency standby generator for the wireless facility. The new equipment area would be enclosed and secured with new walls, locked metal gates, and a roof element to match the existing metal roof that covers a portion of the existing enclosure area. The existing landscape planters would be extended along the front of the new wall areas. A new trash enclosure would be installed towards the southeastern corner of the site and would be located within an existing landscape planter area and designed to conform to current storm water requirements. Staff feels the proposed

project would be consistent with the Communications Antennas Ordinance since the facility would be incorporated into the architecture of an existing commercial office building and the project would be considered a stealthy design. Therefore the proposed facility would not result in any visual, noise or compatibility impacts with surrounding uses.

Conformance with FCC Emission Requirements

Operation of the facility would generate electromagnetic emissions (RF radiation). A RF study was prepared for the project by Sitesafe to determine whether the proposed communication facility complies with the FCC Radio Frequency Safety Guidelines. The study assumes a worst case scenario at maximum capacity, and compares the figures to existing conditions and standards. The study also factors in the emissions from the two adjacent wireless facilities on the church property. FCC regulations define two separate tiers of exposure limits: Occupational or "Controlled Environment" and General Public or "Uncontrolled environment." The General Public limits generally are five times more conservative or restrictive than the Occupational limit. These limits apply to accessible areas where workers or the general public may be exposed to Radio Frequency electromagnetic fields. The study concluded the anticipated Maximum Permissible Exposure (MPE) limits on the ground level (uncontrolled environment) would be less than 20% of FCC limits. Based on FCC and OSHA requirements, the applicant will need to provide RF alert signage and/or barriers to avoid potential exposure issues at the roof level or where personnel could come into contact with the antennas. The recommendations in the study have been included as conditions of approval for the project. A copy of the study has been attached with this report.

SUPPLEMENT TO STAFF REPORT/DETAILS OF REQUEST

A. PHYSICAL CHARACTERISTICS

The project site consists of approximately 3.20 acres of commercial zoned property and is developed with a 48,800 SF, two-story medical building, paved parking and ornamental landscaping. The property fronts onto and takes access from Citracado Parkway, which is designated as a Collector Road (84' R-O-W). Citracado Parkway has been improved to its ultimate width across the project frontage. The property is situated at a higher elevation than Citracado Parkway, with landscaped slopes along the project frontage.

B. SUPPLEMENTAL DETAILS OF REQUEST

1. Property Size: 3.20 acres
2. Building Size: 48,400 SF
3. Building Height: Two story, with varying roof heights from approx. 17.5', 22', 30' and 36' (including rooftop mechanical screens)
4. Building Colors: Exterior stucco ranging from off-white, tans, purple and sage/green
5. Panels: Total of 12 (48.5" L x 11.2" x 5.2" D) three variations of these antennas specifications to be used. Four antennas used per sector with three sectors on top of the building.
6. Screening: Antenna panels and mechanical equipment to be located behind existing mechanical screening. New RF transparent panels to be installed in the existing mechanical screening and textured/colored to match existing building.
7. Power Density: Verizon – less than 20% of the FCC General Public Limit for Maximum Permissible Exposure (MPE), which includes the cumulative from all nearby carriers.
8. Equipment: Support equipment to be located within an enclosed equipment area towards the northwestern corner of the building.
9. Generator: 20 kW emergency standby generator with a 52 gallon diesel tank on a concrete pad with a containment curb inside a concrete wall enclosure.
10. Trash Enclosure: 8' W x 20' L x 9' H new trash enclosure with solid corrugated metal roof. Stucco exterior with metal gates. Painted to match exterior stucco color of building.
11. Hours of Operation
Wireless Facility: 24 hours, unmanned

EXHIBIT "A"
FINDINGS OF FACT
PHG 12-0006

Conditional Use Permit

1. Granting this Modification to the Master and Precise Development Plan to allow a personal wireless communication facility on the subject property would not conflict with Commercial policies and would be based on sound principles of land use since the site is zoned for Planned Commercial uses and developed with a medical office building. The Wireless Facilities Guidelines encourages wireless facilities to locate within commercial or industrial zones. The proposed development generally is in response to services required by the community and the facility would enhance communication services in the city without posing a health threat to the surrounding area. The proposed panels and support equipment would be integrated into the architecture of an existing office building which would avoid potential visual impacts in conformance with the Communication Antennas Ordinance. The facility would not result in a potential health hazard to nearby residents since the facility would be within MPE (maximum permissible exposure) limits as indicated in the radio frequency analysis prepared for the project by Sitesafe. Therefore, the proposed facility would be in compliance with the City's Wireless Facility Guidelines, as discussed in the Planning Commission staff report.
2. The proposed personal wireless communication facility would be located within the Planned Development-Commercial zone. Personal wireless communication facilities are allowed within Planned Commercial zones subject to the approval of a Modification to the Master Development Plan. The proposed facility would not result in a substantial alteration of the present or planned land use since the new facilities are small in scale and the antennas and support equipment would be appropriately integrated into existing facilities. Wireless facilities are encouraged to locate within commercial or industrial zoned areas. The proposal would not cause deterioration of bordering land uses since the antennas would be fully screened (stealthy design) and the location, number and size of the panels have been designed to integrate into the design and scale of the existing facility. Therefore, the proposed project would not result in any adverse impacts. The proposed personal wireless communication facility also would not be hazardous to the health of nearby residents since the radio frequency (RF) analysis prepared for the project concluded the maximum operation levels of radiation for the facility would be within the MPE (Maximum Permissible Exposure) limit established by FCC requirements.
3. The proposed Modification to the Master and Precise Development Plan has been considered in relationship to its effect on the community, and the request would be in compliance with the General Plan Policies and the Wireless Facility Guidelines, and would not result in a negative impact to the adjacent neighborhood for the reasons stated above and detailed in the Planning Commission staff report and radio frequency analysis.
4. The proposal is exempt from the requirements of the California Environmental Quality Act (CEQA) in conformance with Section 15303, "New Construction or Conversion of Small Structures" and a Notice of Exemption was prepared for the proposed project. In staff's opinion, the request does not have the potential for causing a significant effect on the environment due to the relatively small size of the facility; is within a secured location; the proposed facility would be located on the roof of an existing commercial/office building behind existing mechanical equipment screening; and the maximum operation levels of radiation for the facility would be within the MPE (Maximum Permissible Exposure) limit established by FCC requirements.

EXHIBIT "B"

CONDITIONS OF APPROVAL PHG 12-0006

General

1. All construction shall comply with all applicable requirements of the Escondido Zoning Code and requirements of the Planning Department, Director of Building, and the Fire Chief.
2. Appropriate access shall be provided to the project site, to the satisfaction of the Fire Department.
3. The legal description attached to the application has been provided by the applicant and neither the City of Escondido nor any of its employees assume responsibility for the accuracy of said legal description.
4. Prior to or concurrent with the issuance of building permits, the appropriate development fees and Citywide Facility fees shall be paid in accordance with the prevailing fee schedule in effect at the time of building permit issuance, to the satisfaction of the Director of Planning and Building.
5. All exterior lighting shall conform to the requirements of Article 1072, Outdoor Lighting (Ordinance No. 86-75). Any proposed lighting shall be indicated on the building plans, and shall include appropriate shields and cut-offs to minimize light spillage onto adjacent properties or unintended surfaces.
6. As proposed, the design, color and materials of the proposed facilities shall be in accordance with the staff report, exhibits and the project's Details of Request, to the satisfaction of the Planning Division. The proposed antennas, support poles and brackets, mechanical equipment, lights and other infrastructures shall be located behind and below the height of the adjacent roof parapets and/or mechanical equipment screens. The new RF screens shall be designed to blend in with existing exterior building materials, colors and textures.
7. The final design of the new trash enclosure shall be in conformance with the City's Storm Water Quality requirements and trash enclosure guidelines.
8. All proposed signage associated with the project must comply with the City of Escondido Sign Ordinance (Ord. 92-47) and the exhibits included in the staff report(s), to the satisfaction of the Planning Division. Appropriate signs providing notice, caution or warning, and other necessary markings, shall be placed at the main site access point(s) and other locations, as may be required, in order to alert maintenance or other workers approaching the antennas to the presence of RF transmissions and to take precautions to avoid exposures in excess of FCC limits. The requirement for the appropriate signage/notice shall be indicated on the building plans.
9. Verizon or any subsequent operator/lease holder of the wireless facility agrees to investigate any complaints related to possible interference with electronic equipment in the surrounding area to determine the cause of the interference. Any interference shall be resolved in a timely manner to the satisfaction of the Director of Community Development. If the facility is determined to be the cause of the electronic interference, Verizon shall solve the problem in a timely manner to the satisfaction of the complainant and the Director of Community Development. In addition, any interference with public safety communications shall be corrected immediately, to the satisfaction of the City of Escondido.
10. Any sublease of the subject area or co-location of any new facilities not identified by this use permit shall require approval of the City of Escondido.
11. All project generated noise shall conform to the City's Noise Ordinance (Ordinance 90-08).
12. If requested by the City of Escondido, Verizon, or any subsequent operator/lease holder of the facilities shall permit co-location of other wireless providers on its facility (subject to City of Escondido Approval) if it can be demonstrated that there would be no adverse effect on the existing facilities/operations.
13. Verizon shall select an independent third party consultant to conduct actual power density measurements of the facility within 90 days after installation and under full operation of the facility. The results of the study shall be

submitted to the Director of Community Development so that the theoretical power density study can be compared to the actual output to ensure compliance with FCC requirements.

14. Verizon Wireless or any subsequent operator/lease holder of the wireless facility shall be responsible for all on-going maintenance of the facility, including the antennas and supporting equipment to ensure the condition of the facility does not appear weathered.
15. All communication facilities on the site shall be promptly removed upon non use of the facilities, to the satisfaction of the Planning Division and Building Department.
16. Any permanent, temporary or stand-by emergency generators must be in conformance with the City's Ordinance and regulations regarding electric generating facilities.
17. All new utilities and utility runs shall be underground, to the satisfaction of the Planning Division.
18. No additional antennas or expansion of this facility shall be permitted without a modification of the Master and Precise Plan and a public hearing before the Planning Commission. Minor changes within the approved size and design parameters may be permitted by the Director of Community Development.
19. The Master and Precise Plan modification shall be null and void if not utilized within twelve months of the effective date of approval, as determined by the Planning Division.
20. This item may be referred back to the Planning Commission upon recommendation of the Director of Community Development for review and possible revocation or modification of the Master and Precise Plan modification upon receipt of nuisance complaints regarding the facility or non-compliance with the Conditions of Approval.
21. A copy of these Conditions of Approval shall be submitted with the submittal of the building plans indicating compliance with all of the Conditions and Details of Request and exhibits contained in the Planning Commission staff report.
22. An inspection by the Planning Division will be required prior to operation of the project. Everything should be installed prior to calling for an inspection, although preliminary inspections may be requested. Contact the project planner at (760) 839-4671 to arrange a final inspection.
23. The City of Escondido hereby notifies the applicant that the County Clerk's Office requires a documentary handling fee of \$50.00 in order to file a Notice of Exemption for the project (environmental determination for the project). The applicant shall remit to the City of Escondido Planning Division, within two working days of the final approval of the project (the final approval being the hearing date of the Planning Commission or City Council, if applicable) a check payable to the "San Diego County Clerk" in the amount of \$50.00. In accordance with California Environmental Quality Act (CEQA) section 15062, the filing of a Notice of Exemption and the posting with the County Clerk starts a 35 day statute of limitations period on legal challenges to the agency's decision that the project is exempt from CEQA. Failure to submit the required fee within the specified time noted above will result in the Notice of Exemption not being filed with the County Clerk, and a 180 day statute of limitations will apply.



CITY OF ESCONDIDO
 PLANNING DIVISION
 201 NORTH BROADWAY
 ESCONDIDO, CA 92025-2798
 (760) 839-4671

Notice of Exemption

To: San Diego County Recorder's Office
 Attn: Vanessa Esquivel
 P.O. Box 121750
 San Diego, CA 92112-1750

From: City of Escondido
 201 North Broadway
 Escondido, CA 92025

Project Title/Case No.: PHG 12-0006 (Verizon – Rady Medical Building)

Project Location - Specific: An approximately 3.20-acre property generally located on the southern side of West Citracado Parkway, east of Interstate 15, addressed as 625 West Citracado Parkway (APN 238-110-43).

Project Location - City: Escondido, **Project Location - County:** San Diego

Description of Project: A modification to a previously approved Master and Precise Development Plan for Verizon Wireless to install up to twelve wireless communication panel antennas and associated support equipment behind existing mechanical screen walls on the roof of the Rady Children's Urgent Care Facility. The existing trash enclosure area adjacent to the building would be modified to house new electrical equipment and a 20 KW standby emergency generator. A new trash enclosure would be constructed towards southwestern area of the site.

Name of Public Agency Approving Project: City of Escondido

Name of Person or Agency Carrying Out Project:

Name Mark Phillips, M&M Telecom Inc. Telephone (619) 379-4373
 Address P.O. Box 55, Poway, CA 92074

Private entity School district Local public agency State agency Other special district

Exempt Status: Categorical Exemption. Section 15303, "New Small Facilities or Structures."

Reasons why project is exempt:

1. The facility would be consistent with the Wireless Facility Guidelines since it would be fully integrated into the architecture of an existing commercial/office building and situated behind existing rooftop mechanical screens. The proposed facility would not result in any noise impacts to existing residences or adjacent properties, or displace any required parking.
2. The site is within an area that currently is developed with commercial/office structures. The size of the proposed facility is relatively small and no physical expansion to the existing building is proposed. No significant grading or removal of native vegetation is proposed or required.
3. The proposed facility would not be hazardous to the health of nearby residents or the general public since the facility would be within maximum permissible exposure (MPE) limits and Federal Communication Commission (FCC) standards.
4. All service and access to the proposed wireless facility are available and would be in conformance with local standards.

Lead Agency Contact Person: Jay Paul, Planning Division Area Code/Telephone/Extension (760) 839-4537

Signature:  May 7, 2012
 Jay Paul, Associate Planner Date

Signed by Lead Agency Date received for filing at OPR: N/A
 Signed by Applicant

**Verizon Wireless
Site ID - South Escondido
Site Name - South Escondido
Site Compliance Report**

**625 West Citracado Parkway
Escondido, CA 92025
San Diego County**

Site visit date: March 30, 2012
Site survey by: Mohamed Frej

Latitude: N33-5-26.78
Longitude: W117-4-45.55
Structure Type: Rooftop

Report generated date: April 2, 2012
Report by: Brian Doehnert
Customer Contact: Arlet Vargas

**Verizon Wireless will be Compliant based on
FCC Rules and Regulations.**

© 2012 Sitesafe, Inc. Arlington, VA



**David Charles Cotton, Jr.
Registered Professional Engineer (Electrical)
State of California, 18838, Expires 2013-Jun-30
Date: 2012-Apr-02**

PHG 12-0006



**Verizon Wireless
South Escondido
Radio Frequency (RF) Site Compliance Report**



625 West Citracado Parkway, Escondido, CA 92025

Table of Contents

1 EXECUTIVE SUMMARY	2
2 REGULATORY BASIS	3
2.1 FCC RULES AND REGULATIONS	3
2.2 OSHA STATEMENT	4
3 SITE COMPLIANCE	5
3.1 SITE COMPLIANCE STATEMENT	5
3.2 ACTIONS FOR SITE COMPLIANCE	5
4 SAFETY PLAN AND PROCEDURES	7
5 ANALYSIS	8
5.1 RF EMISSIONS DIAGRAM	8
5.2 SITE MEASUREMENTS	10
6 SITE AUDIT	12
6.1 SITE ACCESS PROCEDURES	12
6.2 ANTENNA INVENTORY	13
6.3 SITE PICTURES	16
7 FIELD TECHNICIAN CERTIFICATION	22
8 ENGINEER CERTIFICATION	23
APPENDIX A – STATEMENT OF LIMITING CONDITIONS	24
APPENDIX B – ASSUMPTIONS AND DEFINITIONS	25
GENERAL MODEL ASSUMPTIONS	25
USE OF GENERIC ANTENNAS	25
DEFINITIONS	26
APPENDIX C – RULES & REGULATIONS	28
EXPLANATION OF APPLICABLE RULES AND REGULATIONS	28
OCCUPATIONAL ENVIRONMENT EXPLAINED	28
APPENDIX D – GENERAL SAFETY RECOMMENDATIONS	29
ADDITIONAL INFORMATION	30

1 Executive Summary

Verizon Wireless has contracted with Sitesafe, Inc. (Sitesafe), an independent Radio Frequency (RF) regulatory and engineering consulting firm, to determine whether the proposed communications site, South Escondido, located at 625 West Citracado Parkway, Escondido, CA, is in compliance with Federal Communication Commission (FCC) Rules and Regulations for RF emissions.

Sitesafe's field personnel visited South Escondido on March 30, 2012. This report contains a detailed summary of the RF environment at the site including:

- site compliance determination;
- photographs of the site;
- diagram of the site;
- inventory of the make / model of all transmitting antennas found on the site (where possible);
- record of any Maximum Permissible Exposure ("MPE") measurements taken on the site, as applicable; and
- theoretical MPE based on modeling.

This report addresses exposure to radio frequency electromagnetic fields in accordance with the FCC Rules and Regulations for all individuals, classified in two groups, "Occupational or Controlled" and "General Public or Uncontrolled." This **site will be compliant** with the FCC rules and regulations, as described in OET Bulletin 65. The corrective actions needed to make this site compliant are located in Section 3.2.

During our field visit, Sitesafe documented the presence and location of signs and barriers. This document specifically addresses compliance of Verizon Wireless's transmitting facilities independently and in relation to all collocated transmitting facilities, which together constitute the RF environment at the site.

If you have any questions regarding RF safety and regulatory compliance, please do not hesitate to contact Sitesafe's Customer Support Department at (703) 276-1100.

2 Regulatory Basis

2.1 FCC Rules and Regulations

In 1996, the Federal Communication Commission (FCC) adopted regulations for the evaluating of the effects of RF emissions in 47 CFR § 1.1307 and 1.1310. The guideline from the FCC Office of Engineering and Technology is Bulletin 65 ("OET Bulletin 65"), *Evaluating Compliance with FCC Guidelines for Human Exposure to Radio Frequency Electromagnetic Fields*, Edition 97-01, published August 1997. Since 1996 the FCC periodically reviews these rules and regulations as per their congressional mandate.

FCC regulations define two separate tiers of exposure limits: Occupational or "Controlled environment" and General Public or "Uncontrolled environment". The General Public limits are generally five times more conservative or restrictive than the Occupational limit. These limits apply to accessible areas where workers or the general public may be exposed to Radio Frequency (RF) electromagnetic fields.

Occupational or Controlled limits apply in situations in which persons are exposed as a consequence of their employment and where those persons exposed have been made fully aware of the potential for exposure and can exercise control over their exposure.

An area is considered a Controlled environment when access is limited to these aware personnel. Typical criteria are restricted access (i.e. locked or alarmed doors, barriers, etc.) to the areas where antennas are located coupled with proper RF warning signage. A site with Controlled environments is evaluated with Occupational limits.

All other areas are considered Uncontrolled environments. If a site has no access controls or no RF warning signage it is evaluated with General Public limits.

The theoretical modeling of the RF electromagnetic fields has been performed in accordance with OET Bulletin 65. The Maximum Permissible Exposure (MPE) limits utilized in this analysis are outlined in the following diagram:

FCC Limits for Maximum Permissible Exposure (MPE)
Plane-wave Equivalent Power Density

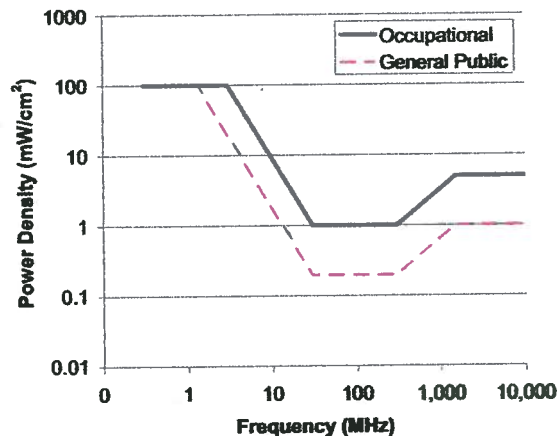

Limits for Occupational/Controlled Exposure (MPE)

Frequency Range (MHz)	Electric Field Strength (E) (V/m)	Magnetic Field Strength (H) (A/m)	Power Density (S) (mW/cm ²)	Averaging Time E ² , H ² or S (minutes)
0.3-3.0	614	1.63	(100)*	6
3.0-30	1842/f	4.89/f	(900/f ²)*	6
30-300	61.4	0.163	1.0	6
300-1500	--	--	f/300	6
1500-100,000	--	--	5	6

Limits for General Population/Uncontrolled Exposure (MPE)

Frequency Range (MHz)	Electric Field Strength (E) (V/m)	Magnetic Field Strength (H) (A/m)	Power Density (S) (mW/cm ²)	Averaging Time E ² , H ² or S (minutes)
0.3-1.34	614	1.63	(100)*	30
1.34-30	824/f	2.19/f	(180/f ²)*	30
30-300	27.5	0.073	0.2	30
300-1500	--	--	f/1500	30
1500-100,000	--	--	1.0	30

f = frequency in MHz *Plane-wave equivalent power density

2.2 OSHA Statement

The General Duty clause of the OSHA Act (Section 5) outlines the occupational safety and health responsibilities of the employer and employee. The General Duty clause in Section 5 states:

(a) Each employer –

- (1) shall furnish to each of his employees employment and a place of employment which are free from recognized hazards that are causing or are likely to cause death or serious physical harm to his employees;
- (2) shall comply with occupational safety and health standards promulgated under this Act.

(b) Each employee shall comply with occupational safety and health standards and all rules, regulations, and orders issued pursuant to this Act which are applicable to his own actions and conduct.

OSHA has defined Radiofrequency and Microwave Radiation safety standards for workers who may enter hazardous RF areas. Regulation Standards 29 CFR § 1910.147 identify a generic Lock Out Tag Out procedure aimed to control the unexpected energization or start up of machines when maintenance or service is being performed.

3 Site Compliance

3.1 Site Compliance Statement

Upon evaluation of the cumulative RF emission levels from all operators at this site, and a thorough review of site access procedures, RF hazard signage and visible antenna locations, Sitesafe has determined that:

This **site will be compliant** with the FCC rules and regulations, as described in OET Bulletin 65. The corrective actions needed to make this site compliant are located in Section 3.2.

Verizon Wireless is predicted to contribute **greater than 5%** of the maximum permissible exposure (MPE) based on theoretical modeling using parameters supplied by the client. A detailed explanation of the 5% rule can be found in the Definition section of Appendix B.

The compliance determination is based on Occupational MPE levels due to theoretical modeling and/or physical measurements, RF signage placement, proposed antenna inventory and the level of restricted access to the antennas at the site. Any deviation from the Verizon Wireless's proposed deployment plan could result in the site being rendered non-compliant. Measurements have also been performed to validate the assumptions used in our theoretical modeling of this site.

Modeling is used for determining compliance and the percentage of MPE contribution. Measurements provide a view of MPE percentage levels at the site at the time of Sitesafe's visit and are used to validate modeling results.

3.2 Actions for Site Compliance

Based on common industry practice and our understanding of FCC and OSHA requirements, this section provides a statement of recommendations for site compliance. RF alert signage recommendations have been proposed based on existing measurements and theoretical analysis of MPE levels. Sitesafe has documented the locations of any RF signs and barriers that are required for compliance. Barriers can consist of locked doors, fencing, railing, rope, chain, paint striping or tape, combined with RF alert signage.

This site will be in compliance with the FCC rules and regulations. Verizon Wireless contributes greater than 5% of the maximum permissible exposure (MPE); therefore, additional action is required by Verizon Wireless to attain compliance. It is recommended that Verizon Wireless review Appendix D in order to maintain a current RF Safety Awareness program.



Sitesafe found one or more issues that led to our determination. The site will be made compliant if the following changes are implemented:

Verizon Wireless Proposed Alpha Sector Location

Yellow caution sign required.

Rope or chain barrier or fencing or painted or tape stripes required

Verizon Wireless Proposed Beta Sector Location

Yellow caution sign required.

Rope or chain barrier or fencing or painted or tape stripes required

Verizon Wireless Proposed Gamma Sector Location

No action required.

or,

- Verizon Wireless can either raise their antenna centerlines or decrease the Effective Radiated Power (ERP) of the appropriate antennas, thereby reducing energy levels to below the Occupational MPE limit;

4 Safety Plan and Procedures

The following items are general safety recommendations that should be administered on a site by site basis as needed by the carrier.

General Maintenance Work: Any maintenance personnel required to work immediately in front of antennas and / or in areas indicated as above 100% of the Occupational MPE limits should coordinate with the wireless operators to disable transmitters during their work activities.

Training and Qualification Verification: All personnel accessing areas indicated as exceeding the General Population MPE limits should have a basic understanding of EME awareness and RF Safety procedures when working around transmitting antennas. Awareness training increases a workers understanding to potential RF exposure scenarios. Awareness can be achieved in a number of ways (e.g. videos, formal classroom lecture or internet based courses).

Physical Access Control: Access restrictions to transmitting antennas locations is the primary element in a site safety plan. Examples of access restrictions are as follows:

- Locked door or gate
- Alarmed door
- Locked ladder access
- Restrictive Barrier at antenna (e.g. Chain link with posted RF Sign)

RF Signage: Everyone should obey all posted signs at all times. RF signs play an important role in properly warning a worker prior to entering into a potential RF Exposure area.

Assume all antennas are active: Due to the nature of telecommunications transmissions, an antenna transmits intermittently. Always assume an antenna is transmitting. Never stop in front of an antenna. If you have to pass by an antenna, move through as quickly and safely as possible thereby reducing any exposure to a minimum.

Maintain a 3 foot clearance from all antennas: There is a direct correlation between the strength of an EME field and the distance from the transmitting antenna. The further away from an antenna, the lower the corresponding EME field is.

Site RF Emissions Diagram: Section 5 of this report contains an RF Diagram that outlines various theoretical Maximum Permissible Exposure (MPE) areas at the site. The modeling is a worst case scenario assuming a duty cycle of 100% for each transmitting antenna at full power. This analysis is based on one of two access control criteria: General Public criteria means the access to the site is uncontrolled and anyone can gain access. Occupational criteria means the access is restricted and only properly trained individuals can gain access to the antenna locations.

5 Analysis

5.1 RF Emissions Diagram

The RF diagram(s) below display theoretical spatially averaged percentage of the Maximum Permissible Exposure for all systems at the site unless otherwise noted. These diagrams use modeling as proscribed in OET Bulletin 65 and assumptions detailed in Appendix B.

The key at the bottom of each diagram indicates if percentages displayed are referenced to FCC Occupational or General Public Maximum Permissible Exposure (MPE) limits. Color coding on the diagram is as follows:

- Areas indicated as Gray are below 5% of the MPE limits.
- Green represents areas predicted to be between 5% and 20% of the MPE limits.
- Yellow represents areas predicted to be between 20% and 100% of the MPE limits.
- Red areas indicated predicted levels greater than 100% of the MPE limits.

General Population diagrams are specified when an area is accessible to the public; i.e. personnel that do not meet Occupational or RF Safety trained criteria, could gain access.

If trained occupational personnel require access to areas that are delineated as Red or above 100% of the limit, Sitesafe recommends that they utilize the proper personal protection equipment (RF monitors), coordinate with the carriers to reduce or shutdown power, or make real-time power density measurements with the appropriate power density meter to determine real-time MPE levels. This will allow the personnel to ensure that their work area is within exposure limits.

The key at the bottom also indicates the level or height of the modeling with respect to the main level. The origin is typically referenced to the main rooftop level, or ground level for a structure without access to the antenna level. For example:

Average from 0 feet above to 6 feet above origin

and

Average from 20 feet above to 26 feet above origin

The first indicates modeling at the main rooftop (or ground) level averaged over 6 feet. The second indicates modeling at a higher level (possibly a penthouse level) of 20 feet averaged over 6 feet.

Abbreviations used in the RF Emissions Diagrams

PH=##'	Penthouse at ## feet above main roof
M##	Measurement ## taken during a site visit

As discussed in Section 5, site measurement locations for spatial average measurements collected at the time of Sitesafe's visit have been added to the RF

emissions diagram. While the theoretical modeling represents worst case MPE levels based on the assumption(s) detailed above, the measurement data is a snapshot of MPE levels at the time of our visit, and dependent on transmitter duty cycle, system implementation and emissions from other RF sources at nearby antenna sites.

Additional Information in the RF Emissions Diagrams Key

The RF Emission Diagram provides indications of RF signage, barriers and locked doors. The table below lists the abbreviations used to indicate locked doors, signs and barriers:

Table 1: RF Signage and Barrier Key					
RF Signage			Barriers		
Type	Existing Location	Recommended Location	Type	Existing Location	Recommended Location
Notice	NE	NR	Locked Door	LE	LR
Caution	CE	CR	Fencing	RE	RR
Warning	WE	WR	Rope Chain		
Info Sign	IE		Paint Stripes		

As discussed in Section 5, site measurements collected at the time of Sitesafe's visit have been added to the RF Emission diagrams. While the software modeling represents theoretical MPE levels based on the assumptions detailed above, the site measurement data is a snapshot of MPE levels, and dependent on transmitter duty cycle, system implementation and emissions from other RF sources at nearby antenna sites.

RF Emissions Diagram for: South Escondido Ground Level

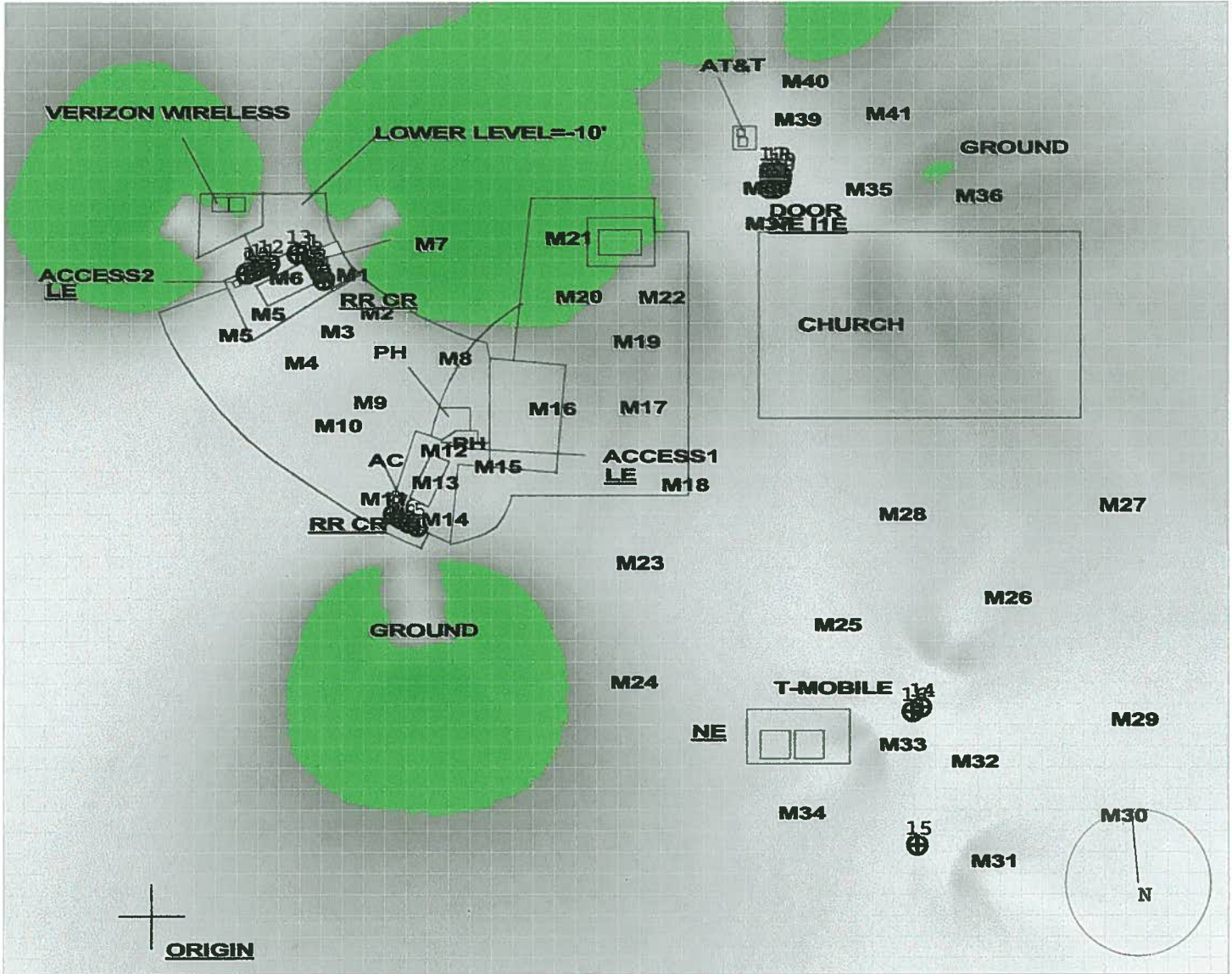

% of FCC Public Exposure Limit
Average from 0 feet above to 6 feet above origin

- $100 \leq X$
- $20 \leq X < 100$
- $5 \leq X < 20$
- $X \leq 5$



www.sitesafe.com

Sitesafe ID# 80492

Site Name: South Escondido

Sitesafe Inc. assumes no responsibility for modeling results not verified by Sitesafe personnel.
Contact Sitesafe Inc. for modeling assistance: (760) 678-1100.
Sitesafe TC Version Unavailable
3/20/12

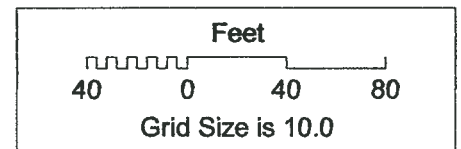

RF Emissions Diagram for: South Escondido Accessible Roof Level 29'

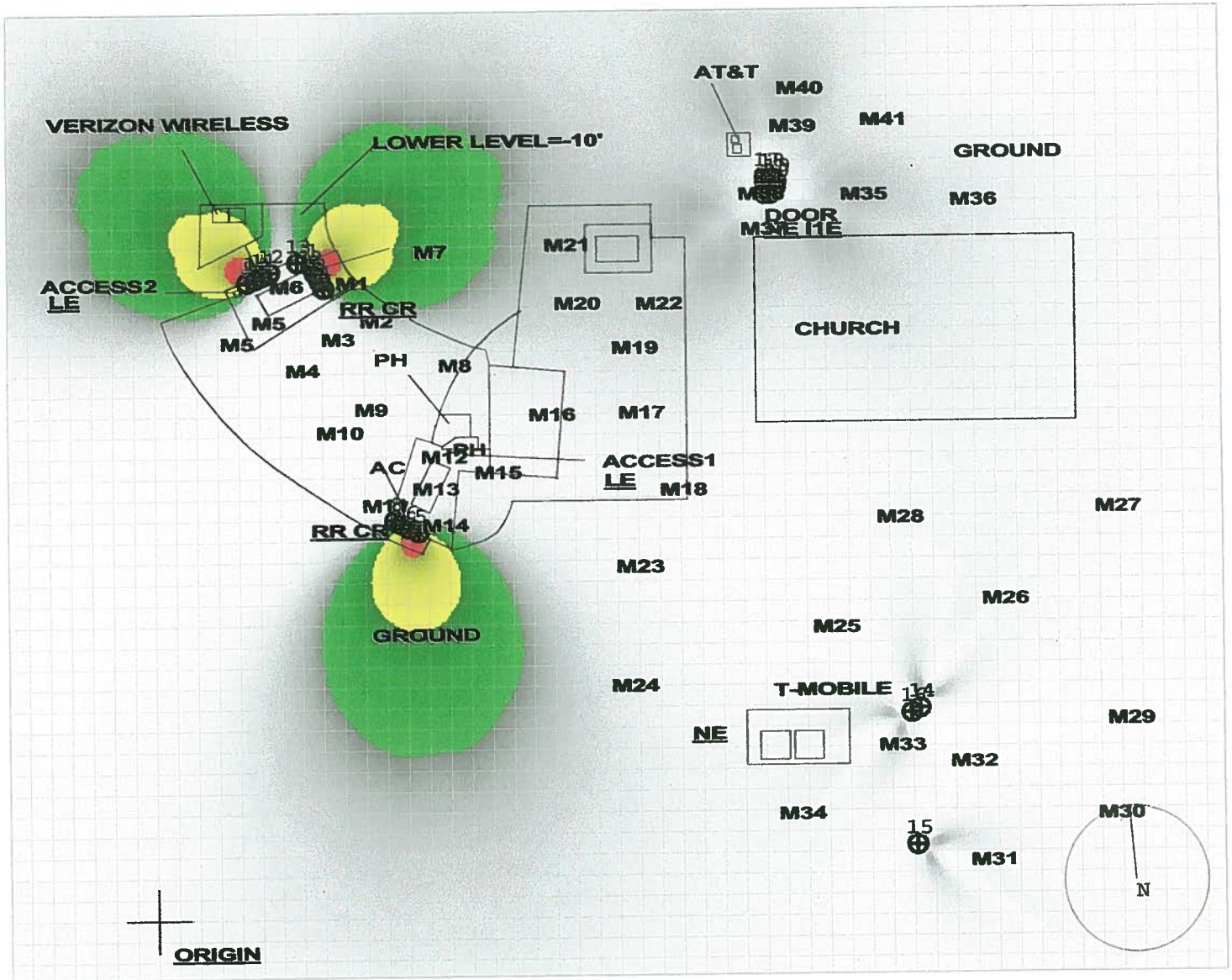

% of FCC Occupational Exposure Limit
Average from 29 feet above to 35 feet above origin

- $100 \leq X$
- $20 \leq X < 100$
- $5 \leq X < 20$
- $X \leq 5$

site safe
www.sitesafe.com
Sitesafe ID# 80492
Site Name: South Escondido

Sitesafe Inc. assumes no responsibility for modeling results not verified by Sitesafe personnel.
Contact Sitesafe Inc. for modeling assistance (760) 276-1100.
Classified Version Unavailable
3/2/2012

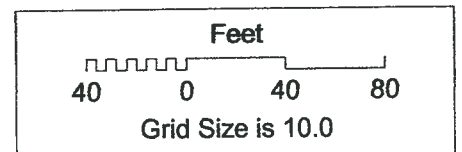

RF Emissions Diagram for: South Escondido Accessible Roof Level 29' - Verizon Wireless Contribution Detail View

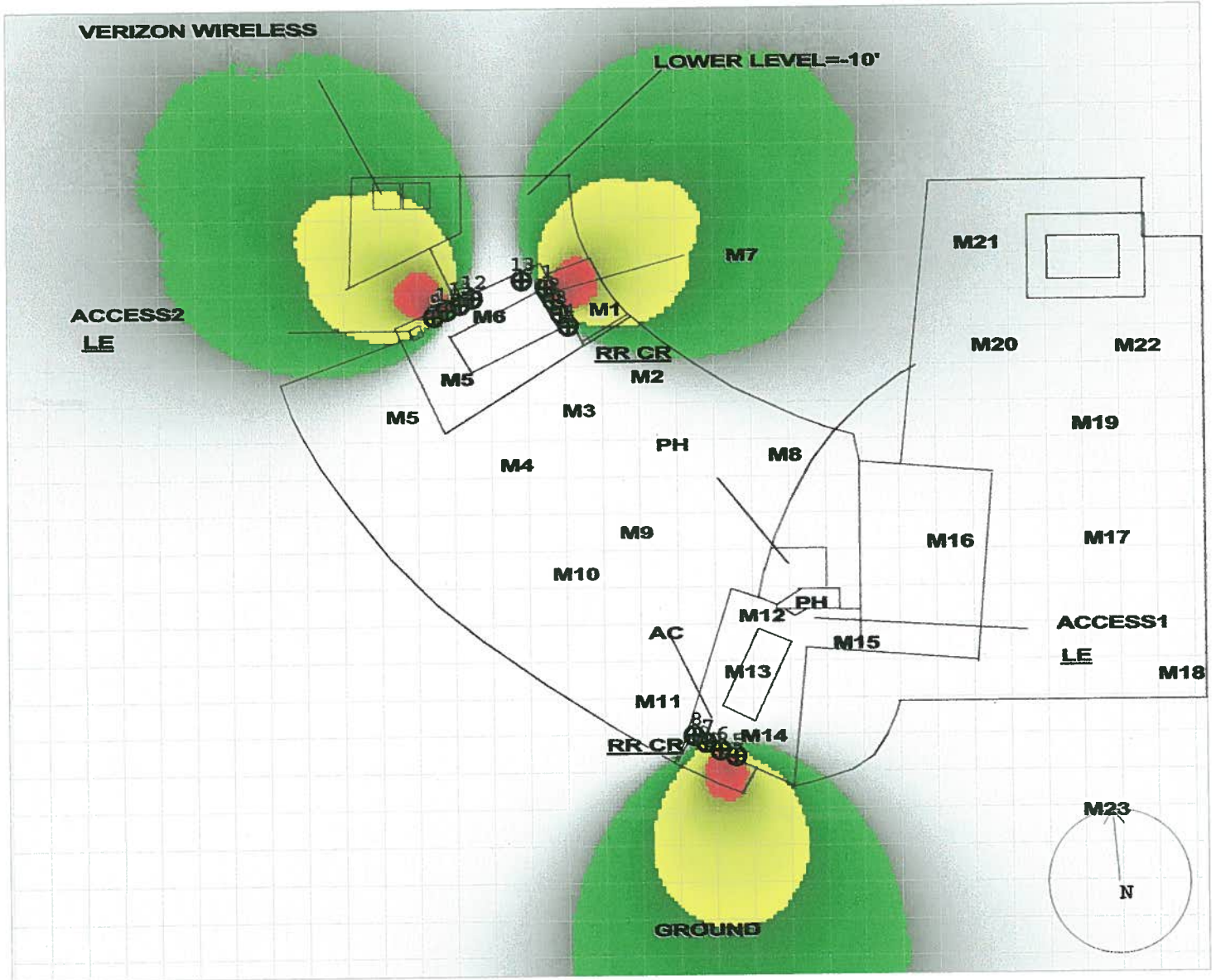

% of FCC Occupational Exposure Limit
Average from 29 feet above to 35 feet above origin

- $100 \leq X$
- $20 \leq X < 100$
- $5 \leq X < 20$
- $X \leq 5$

sitesafe
www.sitesafe.com
Sitesafe ID# 80492
Site Name: South Escondido

Sitesafe Inc. assumes no responsibility for modeling results not verified by Sitesafe personnel.
Contact Sitesafe Inc. for modeling assistance (703) 276-1100.
Sitesafe/TC Version Unavailable
3/22/2012

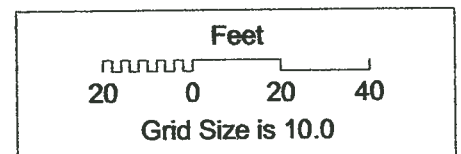

RF Emissions Diagram for: South Escondido Verizon Wireless Alpha Sector Barrier View

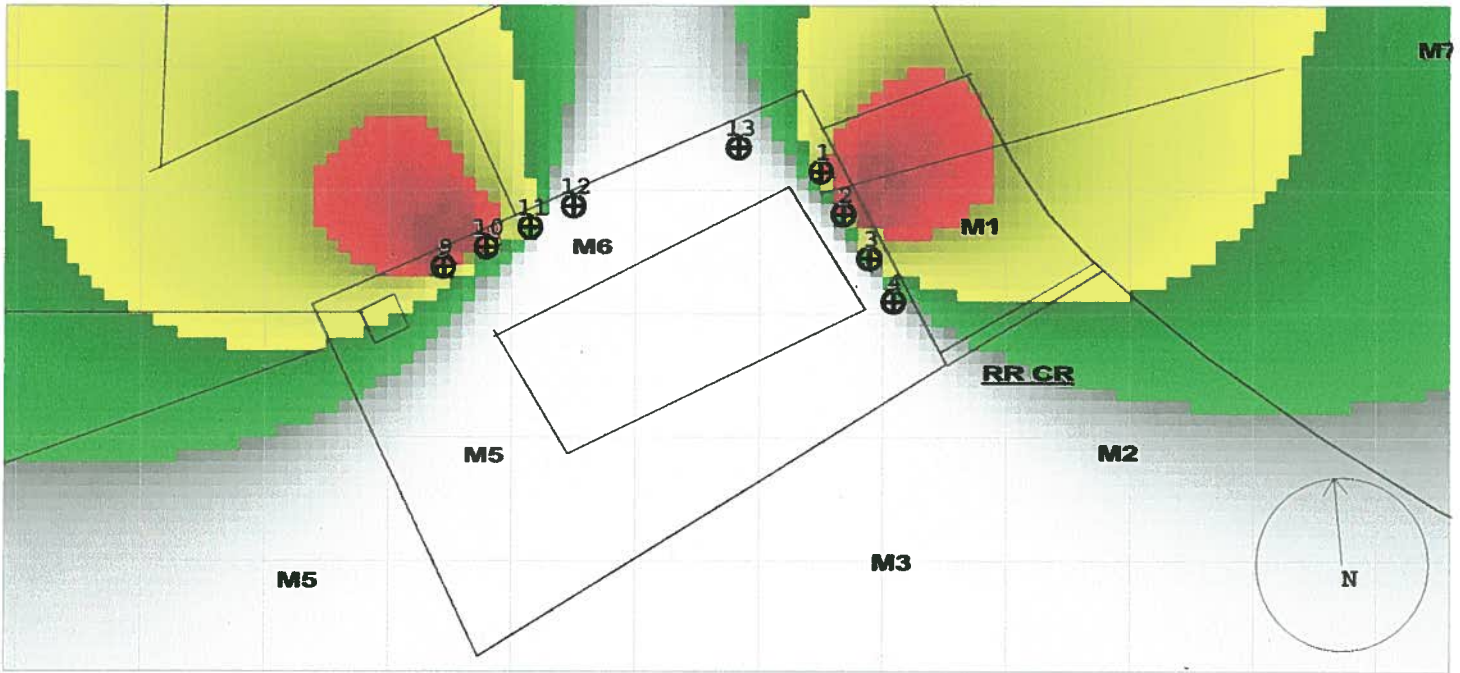

% of FCC Occupational Exposure Limit
Average from 29 feet above to 35 feet above origin

- $100 \leq X$
- $20 \leq X < 100$
- $5 \leq X < 20$
- $X \leq 5$



www.sitesafe.com

Sitesafe ID# 80492

Site Name: South Escondido

Sitesafe Inc. assumes no responsibility for modeling results not verified by Sitesafe personnel.
Contact Sitesafe Inc. for modeling assistance (703) 276-1100.
Standard Version Unavailable
3/2/2012

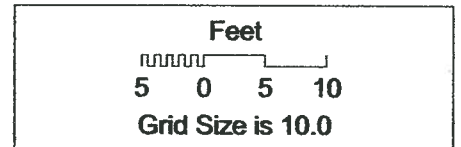

RF Emissions Diagram for: South Escondido Verizon Wireless Beta Sector Barrier Overview

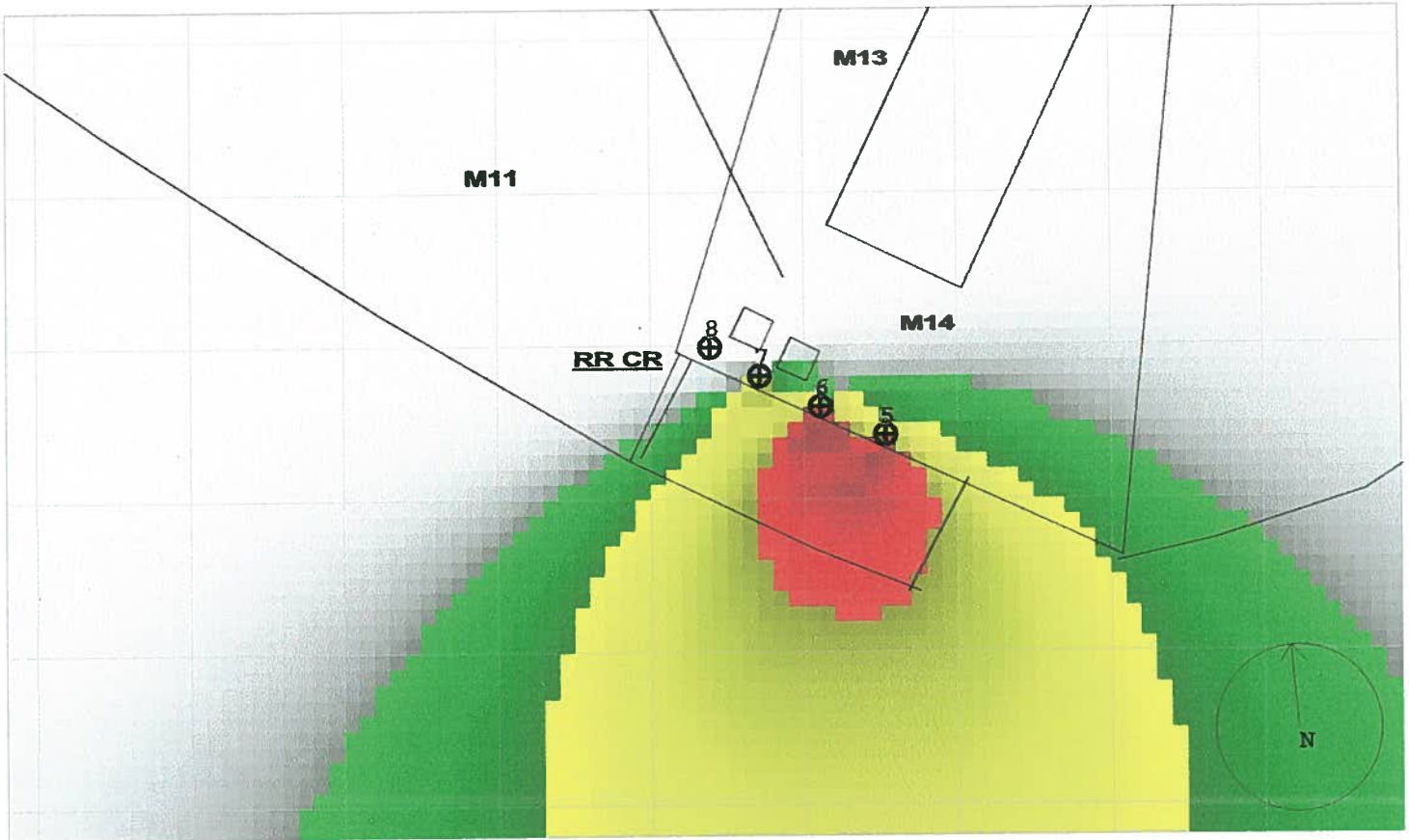

% of FCC Occupational Exposure Limit
Average from 29 feet above to 35 feet above origin

- $100 \leq X$
- $20 \leq X < 100$
- $5 \leq X < 20$
- $X \leq 5$

sitesafe
www.sitesafe.com
Sitesafe ID# 80492
Site Name: South Escondido

Sitesafe Inc. assumes no responsibility for modeling results not verified by Sitesafe personnel.
Contact Sitesafe Inc. for modeling assistance (760) 276-1100.
Sitesafe/TC Version Unavailable
3/22/2012

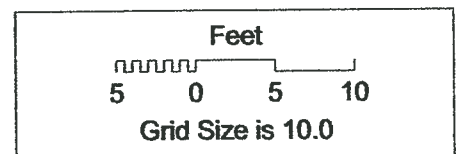

5.2 Site Measurements

This section provides a summary of the measurements collected at the site. Actual measurements locations at which these data points were collected are included in the RF emission diagram provided in Section 6 of this report. Two types of measurements were collected at each measurement location: maximum (peak) and spatial average. The spatial average measurement consists of a collection of ten (10) measurements within a ten (10) second time interval taken from zero (0) to six (6) feet in height. The purpose of this measurement technique is to identify the average power density over the dimensions of a typical human body.

Table 2 below contains all the measurements collected from accessible areas located at the site at the time of Sitesafe's visit. Whenever possible, measurements are taken in front of the antenna in the transmitting direction. However, because of the antenna configuration at this site, specific emissions could not be discerned from nearby facilities, and no attempt was made to determine power density levels from a specific transmitting antenna.

Highest Measured Occupational Level: <1%

This value is equal to:

Highest General Public Level: <5%.

Measurements Points	Spatial Average	Maximum	Measurements Points	Spatial Average	Maximum
M1	<1 %	<1 %	M22	<1 %	<1 %
M2	<1 %	<1 %	M23	<1 %	<1 %
M3	<1 %	<1 %	M24	<1 %	<1 %
M4	<1 %	<1 %	M25	<1 %	<1 %
M5	<1 %	<1 %	M26	<1 %	<1 %
M6	<1 %	<1 %	M27	<1 %	<1 %
M7	<1 %	<1 %	M28	<1 %	<1 %
M8	<1 %	<1 %	M29	<1 %	<1 %
M9	<1 %	<1 %	M30	<1 %	<1 %
M10	<1 %	<1 %	M31	<1 %	<1 %
M11	<1 %	<1 %	M32	<1 %	<1 %
M12	<1 %	<1 %	M33	<1 %	<1 %
M13	<1 %	<1 %	M34	<1 %	<1 %
M14	<1 %	<1 %	M35	<1 %	<1 %
M15	<1 %	<1 %	M36	<1 %	<1 %
M16	<1 %	<1 %	M37	<1 %	<1 %
M17	<1 %	<1 %	M38	<1 %	<1 %
M18	<1 %	<1 %	M39	<1 %	<1 %
M19	<1 %	<1 %	M40	<1 %	<1 %
M20	<1 %	<1 %	M41	<1 %	<1 %
M21	<1 %	<1 %			

RF meters and probes have been calibrated and used according to the manufacturer's specifications. Measurements provide a view of the MPE percentage levels at the site at the time of Sitesafe's site visit and are used to validate modeling results. Theoretical modeling is used for determining compliance and the percentage of MPE contributions.



An RF Emission diagram has been included in section 5 of this document. All measurement locations are identified in this diagram. The locations of measurements in the RF Emission diagram can be cross referenced with Table 2 (above) to determine the actual spatial average and maximum measurement value per location.

6 Site Audit

6.1 Site Access Procedures

A site visit was conducted on March 30, 2012 at approximately 1:00 PM. The weather conditions were Sunny with a temperature of 70 degrees. At that time, a diagram of the site was verified, obtained or produced containing the locations of all visible antennas, RF signs and access points on site. These antennas were recorded and photographed. The antenna make(s)/model(s) and centerlines were verified where possible.

The following information was gathered regarding site access at the facility.

Site access was locked or restricted at the time of the site visit.

Sitesafe field personnel were not permitted access to the site without first signing in with the front desk.

There was no RF Advisory signage posted at any site access point.



Figure 1: Site Access #1 and #2

6.2 Antenna Inventory

The Antenna Inventory shows all transmitting antennas at the site. This inventory was verified on site, and was utilized by Sitesafe to perform theoretical modeling of RF emissions. The inventory coincides with the site diagrams in this report, identifying each antenna's location at South Escondido. The antenna information collected includes the following information:

- Licensee or wireless operator name
- Frequency or frequency band
- Transmitter power – Effective Radiated Power (“ERP”), or Equivalent Isotropic Radiated Power (“EIRP”) in Watts
- Antenna manufacturer make, model, and gain

For other carriers at this site, the use of “Generic” as an antenna model, or “Unknown” for an operator means the information with regard to carrier, their FCC license and/or antenna information was not available nor could it be secured while on site. Equipment, antenna models and nominal transmit power were used for modeling, based on past experience with radio service providers.

The following antenna inventory and representative photographs, on this and the following page, were obtained or verified during the site visit and were utilized to create the site model diagrams:

Table 3: Antenna Inventory

Ant #	Operated By	TX Freq (MHz)	ERP (Watts)	Antenna Gain (dBi)	Az (Deg)	Antenna Model	Ant Type	Len (ft)	Horizontal Half Power Beamwidth (Deg)	Location		
										X	Y	Z
1	Verizon Wireless (Proposed)	751	565	12.50	60	Antel BXA-70063-4CF-6ET	Panel	4	65	75'	312'	35'
2	Verizon Wireless (Proposed)	850	2282	13.00	60	Antel BXA-80063-4CF-5ET	Panel	4	63	77'	308'	35'
3	Verizon Wireless (Proposed)	1900	2651	14.90	60	Antel BXA-171063-8CF-2ET	Panel	8	65	79'	305'	35'
4	Verizon Wireless (Spare)	751	0	12.50	60	Antel BXA-70063-4CF-6ET	Panel	4	65	81'	301'	35'
5	Verizon Wireless (Proposed)	751	565	12.50	180	Antel BXA-70063-4CF-6ET	Panel	4	65	126'	186'	35'
6	Verizon Wireless (Proposed)	850	2282	13.00	180	Antel BXA-80063-4CF-5ET	Panel	4	63	122'	188'	35'
7	Verizon Wireless (Proposed)	1900	2651	14.90	180	Antel BXA-171063-8CF-2ET	Panel	8	65	118'	189'	35'
8	Verizon Wireless (Spare)	751	0	12.50	180	Antel BXA-70063-4CF-6ET	Panel	4	65	114'	191'	35'
9	Verizon Wireless (Proposed)	751	565	12.50	310	Antel BXA-70063-4CF-6ET	Panel	4	65	44'	304'	35'
10	Verizon Wireless (Proposed)	850	2282	13.00	310	Antel BXA-80063-4CF-5ET	Panel	4	63	48'	305'	35'
11	Verizon Wireless (Proposed)	1900	2651	14.90	310	Antel BXA-171063-8CF-2ET	Panel	8	65	51'	307'	35'
12	Verizon Wireless (Spare)	751	0	12.50	310	Antel BXA-70063-4CF-6ET	Panel	4	65	55'	309'	35'
13	Verizon Wireless (Proposed)	18000	100	36.96	0	ANDREW VHLP2-18	Dish	2	2	68'	313'	35'

Table 3: Antenna Inventory

Ant #	Operated By	TX Freq (MHz)	ERP (Watts)	Antenna Gain (dBd)	Az (Deg)	Antenna Model	Ant Type	Len (ft)	Horizontal Half Power Beamwidth (Deg)	Location		
										X	Y	Z
14	T-Mobile	1900	1000	15.20	30	ANDREW TMBXX-6516-R2M	Panel	4	65	363'	99'	24'
15	T-Mobile	1900	1000	15.20	120	ANDREW TMBXX-6516-R2M	Panel	4	65	361'	34'	24'
16	T-Mobile	1900	1000	15.20	240	ANDREW TMBXX-6516-R2M	Panel	4	65	359'	96'	24'
17	AT&T Mobility LLC	850	2000	14.00	0	ANDREW DBXLH-6565A	Panel	4	68	292'	352'	55'
17	AT&T Mobility LLC	1900	2000	16.50	0	ANDREW DBXLH-6565A	Panel	4	65	292'	352'	55'
18	AT&T Mobility LLC	750	1500	11.06	0	Powerwave P65-15-XL-4	Panel	4	65	295'	352'	55'
19	AT&T Mobility LLC	850	2000	14.00	120	ANDREW DBXLH-6565A	Panel	4	68	297'	349'	55'
19	AT&T Mobility LLC	1900	2000	16.50	120	ANDREW DBXLH-6565A	Panel	4	65	297'	349'	55'
20	AT&T Mobility LLC	750	1500	11.06	120	Powerwave P65-15-XL-4	Panel	4	65	297'	347'	55'
21	AT&T Mobility LLC	850	2000	14.00	240	ANDREW DBXLH-6565A	Panel	4	68	294'	344'	55'
21	AT&T Mobility LLC	1900	2000	16.50	240	ANDREW DBXLH-6565A	Panel	4	65	294'	344'	55'
22	AT&T Mobility LLC	750	1500	11.06	240	Powerwave P65-15-XL-4	Panel	4	65	291'	344'	55'

NOTE: X, Y and Z indicate relative position of the antenna to the origin location on the site, displayed in the model results diagram. Specifically, the Z reference indicates antenna height above the main site level unless otherwise indicated. ERP values provided by the client and used in the modeling may be greater than are currently deployed. For other carriers at this site the use of "Generic" as an antenna model or "Unknown" for a wireless operator means the information with regard to carrier, their FCC license and/or antenna information was not available nor could it be secured while on site. Equipment, antenna models and nominal transmit power were used for modelling, based on past experience with radio service providers.

6.3 Site Pictures

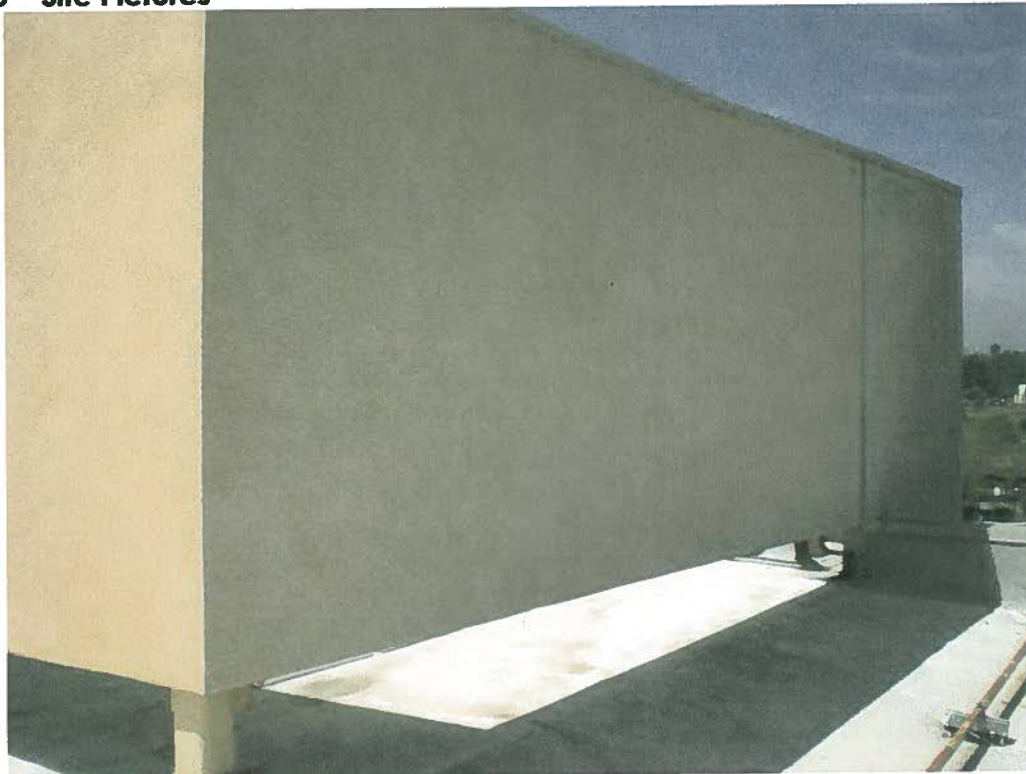

Figure 2: Verizon Wireless Proposed Alpha Sector Antennas #1 through #4



Figure 3: Verizon Wireless Proposed Beta Sector Antennas #5 through #8

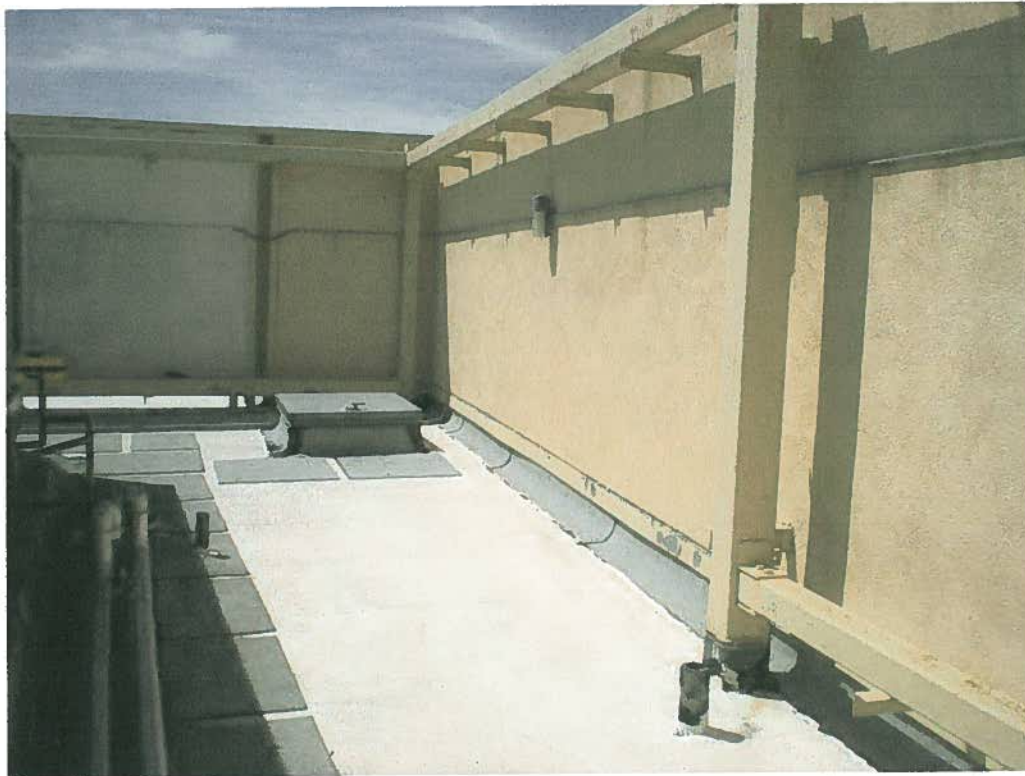

Figure 4: Verizon Wireless Proposed Gamma Sector Antennas #9 through #12



Figure 5: T-Mobile Antennas #14 through #16

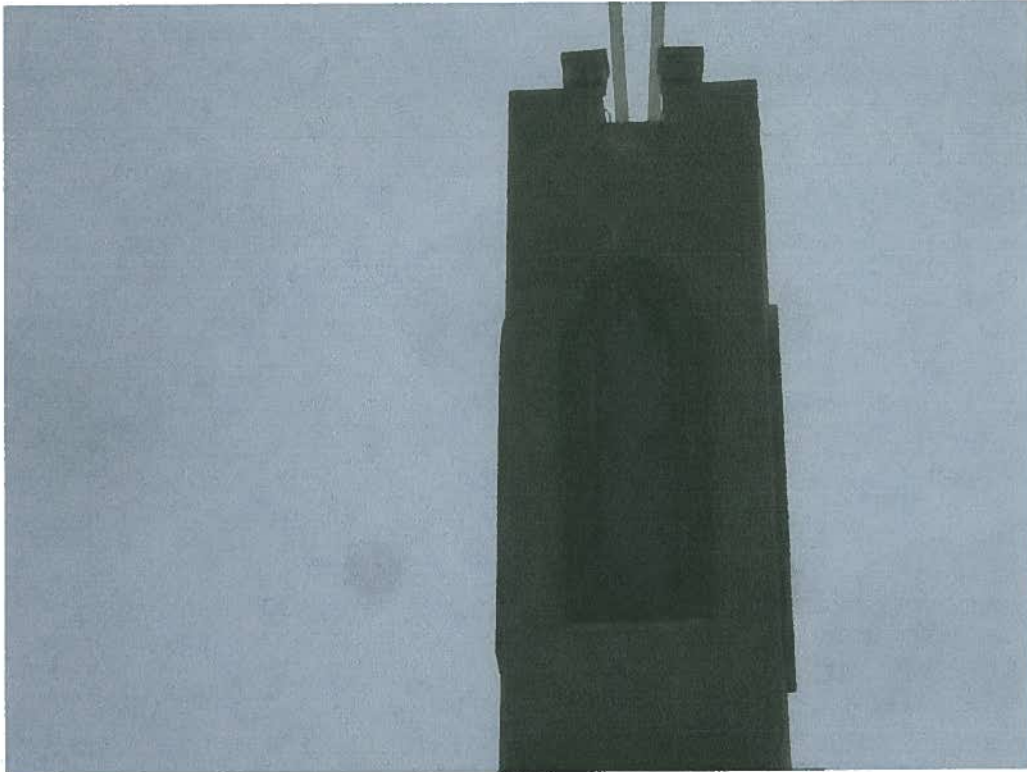

Figure 6: AT&T Mobility, LLC Antennas #17 and #18 Location



Figure 7: AT&T Mobility, LLC Antennas #19 and #20 Location



Figure 8: AT&T Mobilify, LLC Antennas #21 and #22 Location



Figure 9: Main Overview facing North West

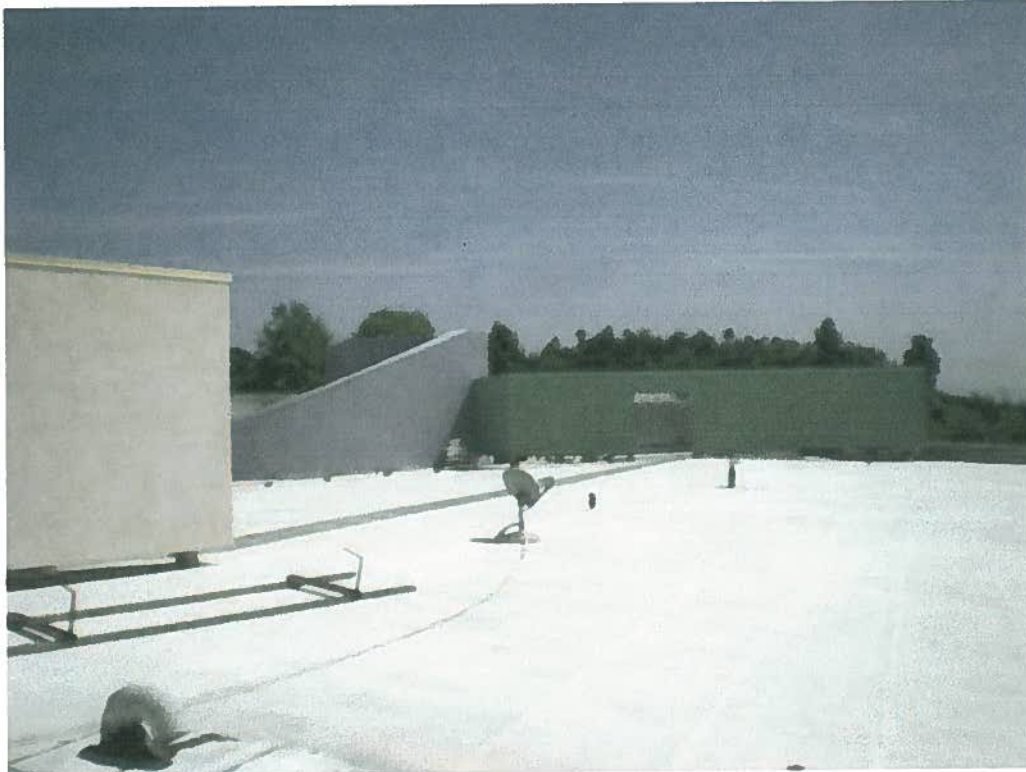

Figure 10: Main Overview facing South East



Figure 11: T-Mobile's Monopoles Overview



Figure 12: AT&T Mobility, LLC Cross Tower Overview



Figure 13: Site Overview



7 Field Technician Certification

I, Mohamed Frej, state:

That I am an employee of Sitesafe, Inc., in Arlington, Virginia, which provides RF compliance services to clients in the wireless communications industry; and

That I have successfully completed RF Safety Awareness training, am aware of the hazards and, therefore, can be exposed to RF fields classified for "Occupational" exposure;

That I am familiar with the Rules and Regulations of the Federal Communications Commission (FCC) as well as the regulations of the Occupational Safety and Health Administration (OSHA), both in general and specifically as they apply to the FCC Guidelines for Human Exposure to Radio-frequency Radiation; and

That I have been trained in the proper use of measurement equipment, and have successfully completed Sitesafe training in policy, procedure and proper site measurement and modeling; and

That I performed survey measurements of the RF environment at the site identified as South Escondido on March 30, 2012 at 1:00 PM in order to determine where there might be electromagnetic energy that is in excess of both the Controlled Environment and Uncontrolled Environment levels; and

That the survey measurements were performed with measurement equipment, model Narda 8718B-10 field intensity meter (serial number 01425) and model A8722D field intensity probe, (serial number 02012) calibrated on 2/14/2011; and

That I have prepared this Site Compliance Report and believe it to be true and accurate to the best of my knowledge and based on data gathered.

By: Mohamed Frej



8 Engineer Certification

The professional engineer whose seal appears on the cover of this document hereby certifies and affirms that:

I am registered as a Professional Engineer in the jurisdiction indicated in the professional engineering stamp on the cover of this document; and

That I am an employee of Sitesafe, Inc., in Arlington, Virginia, at which place the staff and I provide RF compliance services to clients in the wireless communications industry; and

That I am thoroughly familiar with the Rules and Regulations of the Federal Communications Commission (FCC) as well as the regulations of the Occupational Safety and Health Administration (OSHA), both in general and specifically as they apply to the FCC Guidelines for Human Exposure to Radio-frequency Radiation; and

That survey measurements of the site environment of the site identified as South Escondido have been performed in order to determine where there might be electromagnetic energy that is in excess of both the Controlled Environment and Uncontrolled Environment levels; and

That I have thoroughly reviewed this Site Compliance Report and believe it to be true and accurate to the best of my knowledge as assembled by and attested to by Brian Doehnert.

April 2, 2012



Appendix A – Statement of Limiting Conditions

Sitesafe field personnel visited the site and collected data with regard to the RF environment. Sitesafe will not be responsible for matters of a legal nature that affect the site or property. The property was visited under the premise that it is under responsible ownership and management and our client has the legal right to conduct business at this facility.

Due to the complexity of some wireless sites, Sitesafe performed this visit and created this report utilizing best industry practices and due diligence. Sitesafe cannot be held accountable or responsible for anomalies or discrepancies due to actual site conditions (i.e., mislabeling of antennas or equipment, inaccessible cable runs, inaccessible antennas or equipment, etc.) or information or data supplied by Verizon Wireless, the site manager, or their affiliates, subcontractors or assigns.

Sitesafe has provided computer generated model(s) in this Site Compliance Report to show approximate dimensions of the site, and the model is included to assist the reader of the compliance report to visualize the site area, and to provide supporting documentation for Sitesafe's recommendations.

Sitesafe may note in the Site Compliance Report any adverse physical conditions, such as needed repairs, observed during the survey of the subject property or that Sitesafe became aware of during the normal research involved in performing this survey. Sitesafe will not be responsible for any such conditions that do exist or for any engineering or testing that might be required to discover whether such conditions exist. Because Sitesafe is not an expert in the field of mechanical engineering or building maintenance, the Site Compliance Report must not be considered a structural or physical engineering report.

Sitesafe obtained information used in this Site Compliance Report from sources that Sitesafe considers reliable and believes them to be true and correct. Sitesafe does not assume any responsibility for the accuracy of such items that were furnished by other parties. When conflicts in information occur between data provided by a second party and physical data collected by Sitesafe, the physical data will be used.



Appendix B – Assumptions and Definitions

General Model Assumptions

In this site compliance report, it is assumed that all antennas are operating at **full power at all times**. Software modeling was performed for all transmitting antennas located on the site. Sitesafe has further assumed a 100% duty cycle and maximum radiated power.

The site has been modeled with these assumptions to show the maximum RF energy density. Sitesafe believes this to be a worst-case analysis, based on best available data. Areas modeled to predict emissions greater than 100% of the applicable MPE level may not actually occur, but are shown as a worst-case prediction that could be realized real time. Sitesafe believes these areas to be safe for entry by occupationally trained personnel utilizing appropriate personal protective equipment (in most cases, a personal monitor).

Thus, at any time, if power density measurements were made, we believe the real-time measurements would indicate levels below those depicted in the RF emission diagram(s) in this report. By modeling in this way, Sitesafe has conservatively shown exclusion areas – areas that should not be entered without the use of a personal monitor, carriers reducing power, or performing real-time measurements to indicate real-time exposure levels.

Use of Generic Antennas

For the purposes of this report, the use of "Generic" as an antenna model, or "Unknown" for an operator means the information about a carrier, their FCC license and/or antenna information was not provided and could not be obtained while on site. In the event of unknown information, Sitesafe will use our industry specific knowledge of equipment, antenna models, and transmit power to model the site. If more specific information can be obtained for the unknown measurement criteria, Sitesafe recommends remodeling of the site utilizing the more complete and accurate data. Information about similar facilities is used when the service is identified and associated with a particular antenna. If no information is available regarding the transmitting service associated with an unidentified antenna, using the antenna manufacturer's published data regarding the antenna's physical characteristics makes more conservative assumptions.

Where the frequency is unknown, Sitesafe uses the closest frequency in the antenna's range that corresponds to the highest Maximum Permissible Exposure (MPE), resulting in a conservative analysis.

Definitions

5% Rule – The rules adopted by the FCC specify that, in general, at multiple transmitter sites actions necessary to bring the area into compliance with the guidelines are the shared responsibility of all licensees whose transmitters produce field strengths or power density levels at the area in question in excess of 5% of the exposure limits. In other words, any wireless operator that contributes 5% or greater of the MPE limit in an area that is identified to be greater than 100% of the MPE limit is responsible taking corrective actions to bring the site into compliance.

Compliance – The determination of whether a site is safe or not with regards to Human Exposure to Radio Frequency Radiation from transmitting antennas.

Decibel (dB) – A unit for measuring power or strength of a signal.

Duty Cycle – The percent of pulse duration to the pulse period of a periodic pulse train. Also, may be a measure of the temporal transmission characteristic of an intermittently transmitting RF source such as a paging antenna by dividing average transmission duration by the average period for transmission. A duty cycle of 100% corresponds to continuous operation.

Effective (or Equivalent) Isotropic Radiated Power (EIRP) – The product of the power supplied to the antenna and the antenna gain in a given direction relative to an isotropic antenna.

Effective Radiated Power (ERP) – In a given direction, the relative gain of a transmitting antenna with respect to the maximum directivity of a half wave dipole multiplied by the net power accepted by the antenna from the connecting transmitter.

Gain (of an antenna) – The ratio of the maximum intensity in a given direction to the maximum radiation in the same direction from an isotropic radiator. Gain is a measure of the relative efficiency of a directional antennas as compared to an omni directional antenna.

General Population/Uncontrolled Environment – Defined by the FCC, as an area where RFR exposure may occur to persons who are **unaware** of the potential for exposure and who have no control of their exposure. General Population is also referenced as General Public.

Generic Antenna – For the purposes of this report, the use of “Generic” as an antenna model means the antenna information was not provided and could not be obtained while on site. In the event of unknown information, Sitesafe will use our industry specific knowledge of antenna models to select a worst case scenario antenna to model the site.

Isotropic Antenna – An antenna that is completely non-directional. In other words, an antenna that radiates energy equally in all directions.

Maximum Measurement – This measurement represents the single largest measurement recorded when performing a spatial average measurement.

Maximum Permissible Exposure (MPE) – The rms and peak electric and magnetic field strength, their squares, or the plane-wave equivalent power densities associated with these fields to which a person may be exposed without harmful effect and with acceptable safety factor.

Occupational/Controlled Environment – Defined by the FCC, as an area where Radio Frequency Radiation (RFR) exposure may occur to persons who are **aware** of the potential for exposure as a condition of employment or specific activity and can exercise control over their exposure.

OET Bulletin 65 – Technical guideline developed by the FCC's Office of Engineering and Technology to determine the impact of Radio Frequency radiation on Humans. The guideline was published in August 1997.

OSHA (Occupational Safety and Health Administration) – Under the Occupational Safety and Health Act of 1970, employers are responsible for providing a safe and healthy workplace for their employees. OSHA's role is to promote the safety and health of America's working men and women by setting and enforcing standards; providing training, outreach and education; establishing partnerships; and encouraging continual process improvement in workplace safety and health. For more information, visit www.osha.gov.

Radio Frequency Radiation – Electromagnetic waves that are propagated from antennas through space.

Spatial Average Measurement – A technique used to average a minimum of ten (10) measurements taken in a ten (10) second interval from zero (0) to six (6) feet. This measurement is intended to model the average energy an average sized human body will absorb while present in an electromagnetic field of energy.

Transmitter Power Output (TPO) – The radio frequency output power of a transmitter's final radio frequency stage as measured at the output terminal while connected to a load.

Appendix C – Rules & Regulations

Explanation of Applicable Rules and Regulations

The FCC has set forth guidelines in OET Bulletin 65 for human exposure to radio frequency electromagnetic fields. Specific regulations regarding this topic are listed in Part 1, Subpart I, of Title 47 in the Code of Federal Regulations. Currently, there are two different levels of MPE - General Public MPE and Occupational MPE. An individual classified as Occupational can be defined as an individual who has received appropriate RF training and meets the conditions outlined below. General Public is defined as anyone who does not meet the conditions of being Occupational. FCC and OSHA Rules and Regulations define compliance in terms of total exposure to total RF energy, regardless of location of or proximity to the sources of energy.

It is the responsibility of all licensees to ensure these guidelines are maintained at all times. It is the ongoing responsibility of all licensees composing the site to maintain ongoing compliance with FCC rules and regulations. Individual licensees that contribute less than 5% MPE to any total area out of compliance are not responsible for corrective actions.

OSHA has adopted and enforces the FCC's exposure guidelines. A building owner or site manager can use this report as part of an overall RF Health and Safety Policy. It is important for building owners/site managers to identify areas in excess of the General Population MPE and ensure that only persons qualified as Occupational are granted access to those areas.

Occupational Environment Explained

The FCC definition of Occupational exposure limits apply to persons who:

- are exposed to RF energy as a consequence of their employment;
- have been made aware of the possibility of exposure; and
- can exercise control over their exposure.

OSHA guidelines go further to state that persons must complete RF Safety Awareness training and must be trained in the use of appropriate personal protective equipment.

In order to consider this site an Occupational Environment, the site must be controlled to prevent access by any individuals classified as the General Public. Compliance is also maintained when any non-occupational individuals (the General Public) are prevented from accessing areas indicated as Red or Yellow in the attached RF Emissions diagram. In addition, a person must be aware of the RF environment into which they are entering. This can be accomplished by an RF Safety Awareness class, and by appropriate written documentation such as this Site Compliance Report.

All Verizon Wireless employees who require access to this site must complete RF Safety Awareness training and must be trained in the use of appropriate personal protective equipment.

Appendix D – General Safety Recommendations

The following are *general recommendations* appropriate for any site with accessible areas in excess of 100% General Public MPE. These recommendations are not specific to this site. These are safety recommendations appropriate for typical site management, building management, and other tenant operations.

1. All individuals needing access to the main site (or the area indicated to be in excess of General Public MPE) should wear a personal RF Exposure monitor, successfully complete proper RF Safety Awareness training, and have and be trained in the use of appropriate personal protective equipment.

2. All individuals needing access to the main site should be instructed to read and obey all posted placards and signs.

3. The site should be routinely inspected and **this** or similar report updated with the addition of any antennas or upon any changes to the RF environment including:

- adding new antennas that may have been located on the site
- removing of any existing antennas
- changes in the radiating power or number of RF emitters

4. Post the appropriate **NOTICE**, **CAUTION**, or **WARNING** sign at the main site access point(s) and other locations as required. Note: Please refer to RF Exposure Diagrams in Section 5, to inform everyone who has access to this site that beyond posted signs there may be levels in excess of the limits prescribed by the FCC. The signs below are examples of signs meeting FCC guidelines.



5. Ensure that the site door remains locked (or appropriately controlled) to deny access to the general public if deemed as policy by the building/site owner.

6. For a General Public environment the four color levels identified in this analysis can be interpreted in the following manner:

- Areas indicated as Gray are at 5% of the General Public MPE limits or below. This level is safe for a worker to be in at any time.
- Green represents areas predicted to be between 5% and 20% of the General Public MPE limits. This level is safe for a worker to be in at any time.

- Yellow represents areas predicted to be between 20% and 100% of the General Public MPE limits. This level is safe for a worker to be in at any time.
- Red areas indicated predicted levels greater than 100% of the General Public MPE limits. This level is not safe for the General Public to be in.

7. For an Occupational environment the four color levels identified in this analysis can be interpreted in the following manner:

- Areas indicated as Gray are at 5% of the Occupational MPE limits or below. This level is safe for a worker to be in at any time.
- Green represents areas predicted to be between 5% and 20% of the Occupational MPE limits. This level is safe for a worker to be in at any time.
- Yellow represents areas predicted to be between 20% and 100% of the Occupational MPE limits. Only individuals that have been properly trained in RF Health and Safety should be allowed to work in this area. This is not an area that is suitable for the General Public to be in.
- Red areas indicated predicted levels greater than 100% of the Occupational MPE limits. This level is not safe for the Occupational worker to be in for prolonged periods of time. Special procedures must be adhered to such as lock out tag out procedures to minimize the workers exposure to EME.

8. Use of a Personal Protective Monitor: When working around antennas, Sitesafe strong recommends the use of a Personal Protective Monitor (PPM). Wearing a PPM will properly forewarn the individual prior to entering an RF exposure area.

Keep a copy of this report available for all persons who must access the site. They should read this report and be aware of the potential hazards with regards to RF and MPE limits.

Additional Information

Additional RF information is available by visiting both www.Sitesafe.com and www.fcc.gov/oet/rfsafety. OSHA has additional information available at: <http://www.osha-slc.gov/SLTC/radiofrequencyradiation>.